



SEMICONDUCTOR

# 3KP Series

TRANSIENT VOLTAGE SUPPRESSOR  
PEAK PULSE POWER-3000 Watts

## FEATURES

- 3000 Watts Pulse capability
- Excellent clamping capability
- IEC 61000-4-2 ESD 30KV (Air), 30KV (Contact)
- ESD protection of data lines in accordance with IEC 61000-4-2
- EFT protection of data lines in accordance with IEC 61000-4-4
- Fast response time
- High temperature soldering guaranteed: 260°C/10 seconds at terminals
- Component in accordance to RoHS 2011/65/EU

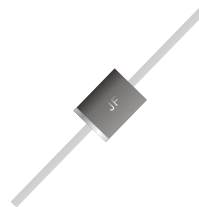

R-6

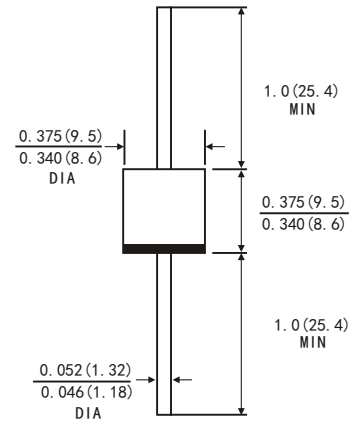

Dimensions in inches and (millimeters)

## MECHANICAL DATA

- Case: R-6 Molded Plastic
- Terminals: Solder Plated
- Mounting Position: Any
- Polarity: By cathode band denotes uni-directional device,
- none cathode band denotes bi-directional device.

## DEVICES FOR BIDIRECTIONAL APPLICATIONS

1. For bi-directional use C suffix for Types .
2. Electrical characteristics apply in both directions.

## MAXIMUM RATINGS AND ELECTRICAL CHARACTERISTICS

(Rating at 25°C ambient temperature unless otherwise specified)

Parameter	Symbol	Value	Units
Peak Pulse Power Dissipation on 10/1000 us Waveform (Note 1, FIG.1)	P <sub>PPM</sub>	Min 3000	W
Power Dissipation on Infinite Heat Sink at T <sub>L</sub> =75°C	P <sub>D</sub>	7.0	W
Peak Pulse Current of on 10/1000us Waveform (Note 1, FIG.3)	I <sub>PPM</sub>	See Table 1	A
Peak Forward Surge Current, 8.3ms Single Half Sine-Wave (Note 2)	I <sub>FSM</sub>	300	A
Operating Junction Temperature Range	T <sub>J</sub>	-55 to 150	°C
Storage Temperature Range	T <sub>STG</sub>	-55 to 150	°C

Note: 1.Non repetitive current pulse , per Fig. 3 and derated above TA=25°C per Fig. 2.

2.Measured on 8.3ms single half sine-wave or equivalent square wave, duty cycle=4 pulses per minute maximum

# RATINGS AND CHARACTERISTIC CURVES (3KP Series)

Type Number		Reverse Stand-Off Voltage	Breakdown Voltage Min. @I <sub>T</sub>	Breakdown Voltage Max. @ I <sub>T</sub>	Test Current	Maximum Clamping Voltage @I <sub>PP</sub>	Peak Pulse Current	Reverse Leakage @V <sub>RMW</sub>
(Uni)	(Bi)	V <sub>RMW</sub> (V)	V <sub>BR MIN</sub> (V)	V <sub>BR MAX</sub> (V)	I <sub>T</sub> (mA)	V <sub>C</sub> (V)	I <sub>PP</sub> (A)	I <sub>R</sub> ( $\mu$ A)
3KP5.0A	3KP5.0CA	5.0	6.40	7.00	50	9.2	326.1	5000
3KP6.0A	3KP6.0CA	6.0	6.67	7.37	50	10.3	291.3	5000
3KP6.5A	3KP6.5CA	6.5	7.22	7.98	50	11.2	267.9	2000
3KP7.0A	3KP7.0CA	7.0	7.78	8.60	50	12.0	250.0	1000
3KP7.5A	3KP7.5CA	7.5	8.33	9.21	5	12.9	232.6	250
3KP8.0A	3KP8.0CA	8.0	8.89	9.83	5	13.6	220.6	150
3KP8.5A	3KP8.5CA	8.5	9.44	10.40	5	14.4	208.3	50
3KP9.0A	3KP9.0CA	9.0	10.00	11.10	5	15.4	194.8	20
3KP10A	3KP10CA	10.0	11.10	12.30	5	17.0	176.5	15
3KP11A	3KP11CA	11.0	12.20	13.50	5	18.2	164.8	2
3KP12A	3KP12CA	12.0	13.30	14.70	5	19.9	150.8	2
3KP13A	3KP13CA	13.0	14.40	15.90	5	21.5	139.5	2
3KP14A	3KP14CA	14.0	15.60	17.20	5	23.2	129.3	2
3KP15A	3KP15CA	15.0	16.70	18.50	5	24.4	123.0	2
3KP16A	3KP16CA	16.0	17.80	19.70	5	26.0	115.4	2
3KP17A	3KP17CA	17.0	18.90	20.90	5	27.6	108.7	2
3KP18A	3KP18CA	18.0	20.00	22.10	5	29.2	102.7	2
3KP20A	3KP20CA	20.0	22.20	24.50	5	32.4	92.6	2
3KP22A	3KP22CA	22.0	24.40	26.90	5	35.5	84.5	2
3KP24A	3KP24CA	24.0	26.70	29.50	5	38.9	77.1	2
3KP26A	3KP26CA	26.0	28.90	31.90	5	42.1	71.3	2
3KP28A	3KP28CA	28.0	31.10	34.40	5	45.4	66.1	2
3KP30A	3KP30CA	30.0	33.30	36.80	5	48.4	62.0	2
3KP33A	3KP33CA	33.0	36.70	40.60	5	53.3	56.3	2
3KP36A	3KP36CA	36.0	40.00	44.20	5	58.1	51.6	2
3KP40A	3KP40CA	40.0	44.40	49.10	5	64.5	46.5	2
3KP43A	3KP43CA	43.0	47.80	52.80	5	69.4	43.2	2
3KP45A	3KP45CA	45.0	50.00	55.30	5	72.7	41.3	2
3KP48A	3KP48CA	48.0	53.30	58.90	5	77.4	38.8	2
3KP51A	3KP51CA	51.0	56.70	62.70	5	82.4	36.4	2
3KP54A	3KP54CA	54.0	60.00	66.30	5	87.1	34.4	2
3KP58A	3KP58CA	58.0	64.40	71.20	5	93.6	32.1	2
3KP60A	3KP60CA	60.0	66.70	73.70	5	96.8	31.0	2
3KP64A	3KP64CA	64.0	71.10	78.60	5	103.0	29.1	2
3KP70A	3KP70CA	70.0	77.80	86.00	5	113.0	26.5	2
3KP75A	3KP75CA	75.0	83.30	92.10	5	121.0	24.8	2
3KP78A	3KP78CA	78.0	86.70	95.80	5	126.0	23.8	2
3KP85A	3KP85CA	85.0	94.40	104.00	5	137.0	21.9	2
3KP90A	3KP90CA	90.0	100.00	111.00	5	146.0	20.5	2
3KP100A	3KP100CA	100.0	111.00	123.00	5	162.0	18.5	2

※ For Bi-directional type having V<sub>RMW</sub> of 10 Volts and less, the I<sub>R</sub> limit is double.

※ For parts without A, the V<sub>BR</sub> is  $\pm$  10% and V<sub>C</sub> is 5% higher than with A parts.

## RATINGS AND CHARACTERISTIC CURVES (3KP Series)

Type Number		Reverse Stand-Off Voltage	Breakdown Voltage Min. @ $I_T$	Breakdown Voltage Max. @ $I_T$	Test Current	Maximum Clamping Voltage @ $I_{PP}$	Peak Pulse Current	Reverse Leakage @ $V_{RWM}$
(Uni)	(Bi)	$V_{RWM}(V)$	$V_{BR\ MIN}(V)$	$V_{BR\ MAX}(V)$	$I_T\ (mA)$	$V_C(V)$	$I_{PP}(A)$	$I_R(\mu A)$
3KP110A	3KP110CA	110.0	122.00	135.00	5	177.0	16.9	2
3KP120A	3KP120CA	120.0	133.00	147.00	5	193.0	15.5	2
3KP130A	3KP130CA	130.0	144.00	159.00	5	209.0	14.4	2
3KP150A	3KP150CA	150.0	167.00	185.00	5	243.0	12.3	2
3KP160A	3KP160CA	160.0	178.00	197.00	5	259.0	11.6	2
3KP170A	3KP170CA	170.0	189.00	209.00	5	275.0	10.9	2
3KP180A	3KP180CA	180.0	200.00	221.00	5	289.0	10.4	2
3KP190A	3KP190CA	190.0	211.00	233.00	5	310.0	9.7	2
3KP200A	3KP200CA	200.0	222.00	246.00	5	329.2	9.1	2
3KP210A	3KP210CA	210.0	233.00	258.00	5	349.5	8.6	2
3KP220A	3KP220CA	220.0	244.00	270.00	5	371.1	8.1	2

※ For Bi-directional type having  $V_{RWM}$  of 10 Volts and less, the  $I_R$  limit is double.

※ For parts without A, the  $V_{BR}$  is  $\pm 10\%$  and  $V_C$  is 5% higher than with A parts.

### I-V Curve Characteristics

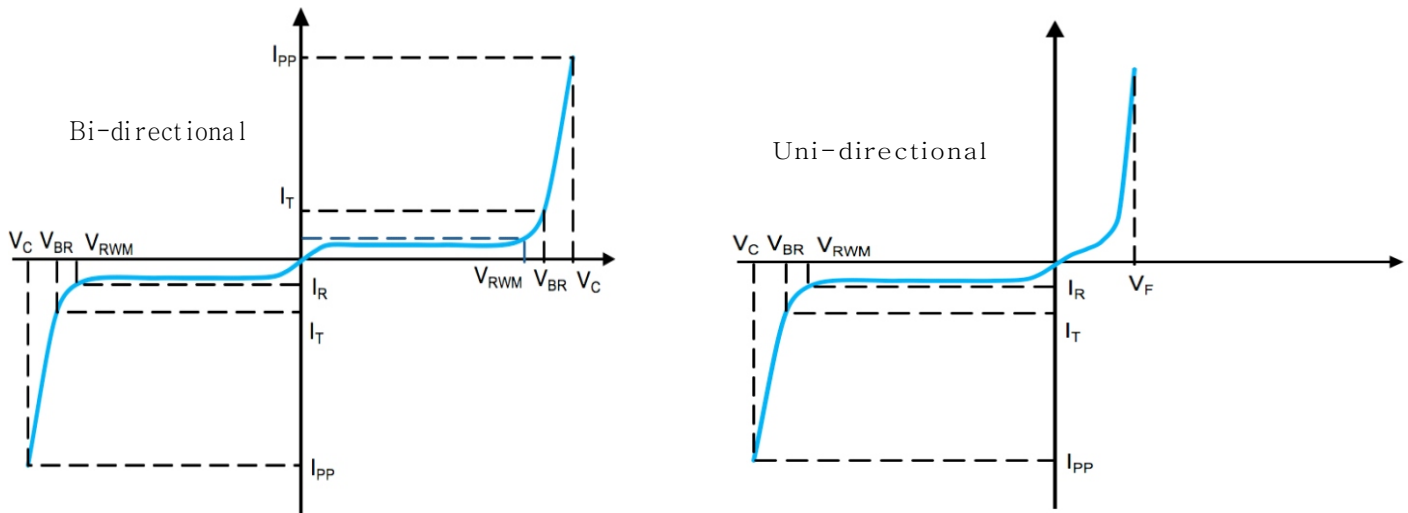

- $P_{PPM}$  Peak Pulse Power Dissipation - Max power dissipation
- $V_{RWM}$  Reverse Stand-off Voltage - Maximum voltage that can be applied to TVS without operation
- $V_{BR}$  Breakdown Voltage – Maximum voltage that flows through the TVS at a specified current ( $I_T$ )
- $V_C$  Clamping Voltage – Peak voltage measured across the TVS at a specified  $I_{PPM}$  (peak impulse current)
- $I_R$  Reverse Leakage Current – Current measured at  $V_R$
- $V_F$  Forward Voltage Drop for Uni-directional

# RATINGS AND CHARACTERISTIC CURVES (3KP Series)

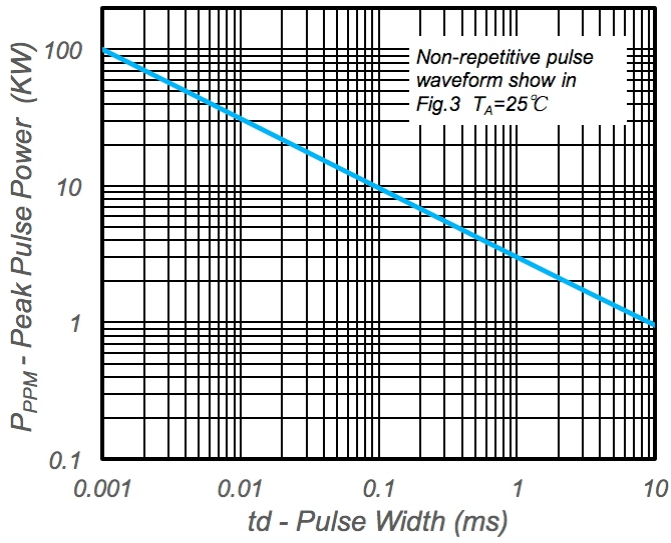

Fig.1 - Peak Pulse Power Rating

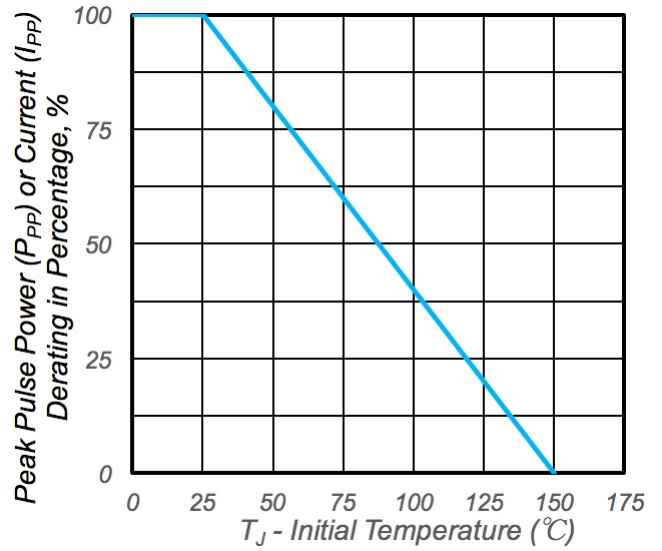

Fig.2 - Pulse Derating Curve

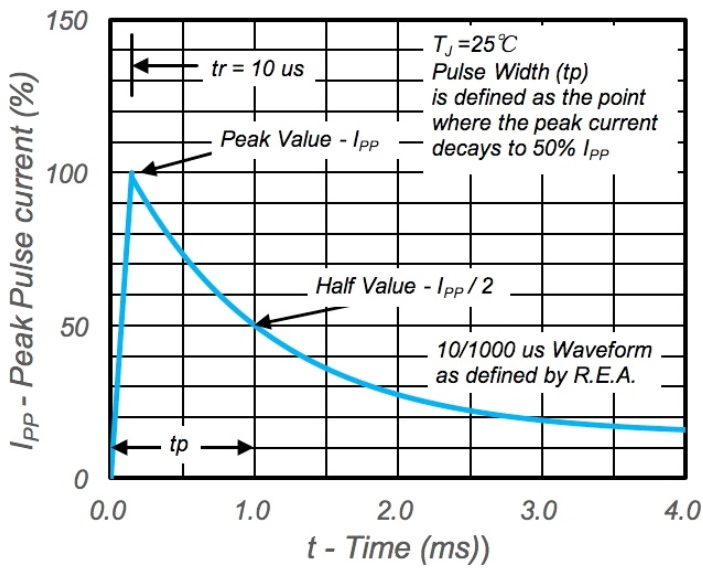

Fig.3 - Pulse Waveform

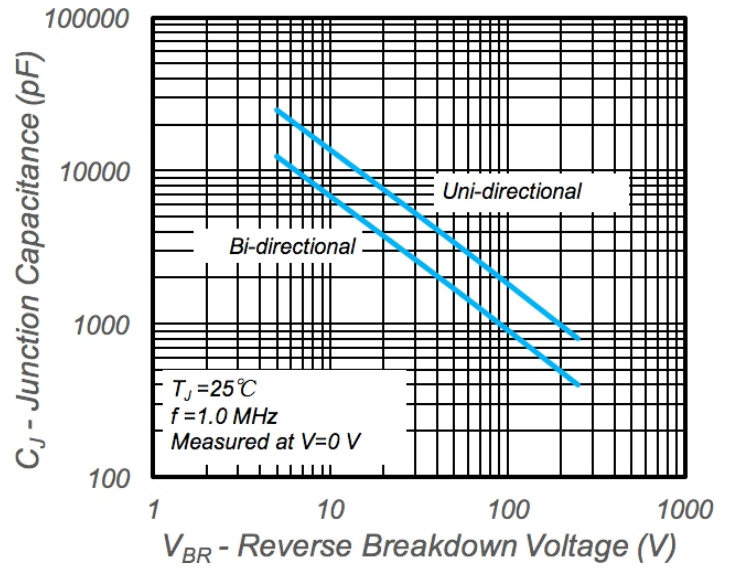

Fig.4 - Typical Junction Capacitance