

# LDC-185 Series

## Compact, LED, 200W Constant Current AC/DC Power Supply



### Key Features:

- 200W Output Power
- UL 8750 Approved
- Constant Current Output
- Active PFC
- 90 - 305 VAC Input
- IP65 / IP67 Rated
- Meets EN 55015, EN 61547
- Dimming Function
- >50 kHour Life Expectancy
- Lightning Surge Protection
- Over Volt/Temp Protection



### MicroPower Direct

292 Page Street  
Suite D  
Stoughton, MA 02072  
USA

T: (781) 344-8226

F: (781) 344-8481

E: sales@micropowerelectronics.com

W: www.micropowerelectronics.com



### Electrical Specifications

Specifications typical @ +25°C, 230 VAC input voltage & rated output current, unless otherwise noted. Specifications subject to change without notice.



Input	Parameter	Conditions	Min.	Typ.	Max.	Units
Input Voltage Range			90		305	VAC
			127		431	VDC
Input Frequency			47		63	Hz
				75		
Inrush Current, See Note 1		230 VAC		2.10		
		115 VAC		0.90		
		230 VAC		0.80		
		264 VAC				
Input Current				0.98 @ 115 VAC		
				0.95 @ 230 VAC		
				0.93 @ 264 VAC		
Power Factor Correction					10	%
Total Harmonic Distortion (THD)		See Note 2				
				1.5		
Turn On Delay, See Note 3		115 VAC		0.5		
		230 VAC				
Leakage Current		277 VAC			75	mA

Output	Parameter	Conditions	Min.	Typ.	Max.	Units
Output Current Accuracy				±5.0		%
			V <sub>IN</sub> = Min to Max	±1.0		%
			See Note 4	2.0		V <sub>P-P</sub>
Line Regulation				±5.0		%
			Outputs Above 71 VDC	±10.0		
Ripple & Noise (20 MHz)		Outputs Below 50 VDC				
		Outputs Above 71 VDC				
Output Ripple Current		115 VAC	12.0			mS
				85		
Hold-Up Time						
Over Temperature Protection						
Short Circuit Protection						
Overload Protection						

General	Parameter	Conditions	Min.	Typ.	Max.	Units
Isolation Voltage, 60S		Input to Output	3,750			
		Input to FG	2,000			VAC
		Output to FG	500			
Insulation Resistance		Input to Output				
		Input to FG	100 MΩ / 500 VDC / 25°C / 70% RH			
		Output to FG				

EMI Characteristics	Parameter	Standard
EMI		EN 55015; EN 6100-3-2, -3; FCC Part 18; CNS 14115; GB 17743
		EN 61547; EN 61000-4-2, -3, -4, -5, -6, -8, -11; GB 17625.1
Surge		10 kV (L/N - FG), 5 kV (L-N)/1.2 x 50 μS

Environmental	Parameter	Conditions	Min.	Typ.	Max.	Units
Operating Temperature Range		Ambient	-40	+25	+70	°C
			-40		+85	°C
Storage Temperature Range						
Cooling						
Humidity					95	%

Physical	Parameter	Conditions	Min.	Typ.	Max.	Units
Case Size						
Weight						See Mechanical Diagrams (Page 4)
						33.1 Oz (950g)

Reliability Specifications	Parameter	Conditions	Min.	Typ.	Max.	Units
MTBF		MIL HDBK 217F, 25°C, Gnd Benign	220			kHours
Life Expectancy		See Note 5	50			kHours
Safety Standards						UL 8750 Approved, Meets EN 61347, GB 19510.1, GB 19510.14
						5 - 500 Hz, 1G, 1 Oct/Min, 2 Cycles, Period for 75 Min. Each Along X, Y, & Z Axis
Vibration						

Model Number	Output				Output Power (W)	Efficiency (% Typ)
	Current		Voltage Range (VDC)	OVP Level (VDC)		
	Max (mA)	Adj. Range (mA)				
LDC-185-0500 x	500	300 - 500	200 - 400	420 - 450	200	92
LDC-185-0700 x	700	360 - 700	143 - 286	320 - 350	200	92
LDC-185-1050 x	1,050	600 - 1,050	95 - 190	210 - 240	200	92
LDC-185-1400 x	1,400	750 - 1,400	71 - 143	160 - 170	200	92
LDC-185-3150 x	3,150	1,650 - 3,150	32 - 58	62 - 80	183	91
LDC-185-3850 x	3,850	2,000 - 3,850	32 - 49	54 - 73	189	91
LDC-185-4200 x	4,200	2,200 - 4,200	27 - 42	49 - 65	177	91
LDC-185-5250 x	5,250	2,750 - 5,250	25 - 35	41 - 55	183	91

Notes:

1. Inrush current is given for a cold start at 25°C.
2. Total Harmonic Distortion (THD) is specified with an input of 230 VAC/50 Hz at full load.
3. Turn on delay is specified at full load.
4. Ripple & noise is measured at 20 MHz. Connection to the unit is made with a 0.1 µF ceramic capacitor and a 22 µF electrolytic capacitor connected in parallel.
5. Life expectancy is calculated at 230 VAC, full load and a case temp of +70°C.
6. Recovery from an over voltage fault is automatic.

Package Type

Model	Ingress Protection	Dimming Function
LDC-185-xxxx A	IP65	Adjust by internal, variable resistor
LDC-185-xxxx B	IP67	Adjust by external resistor, DC voltage level or PWM signal

Derating Curve: Temperature

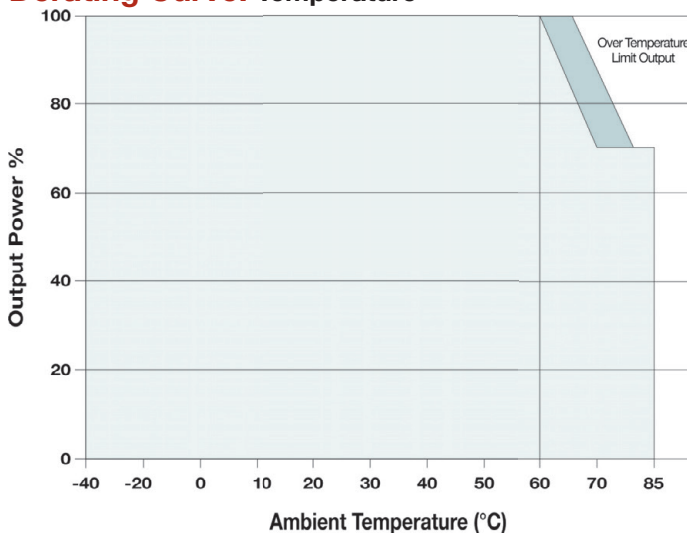

Derating Curve: Input Voltage

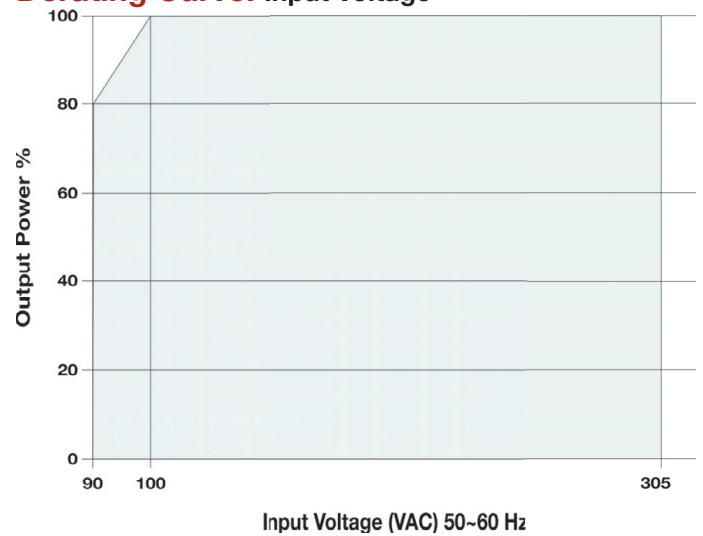

Efficiency vs Load: LDC-185-5250

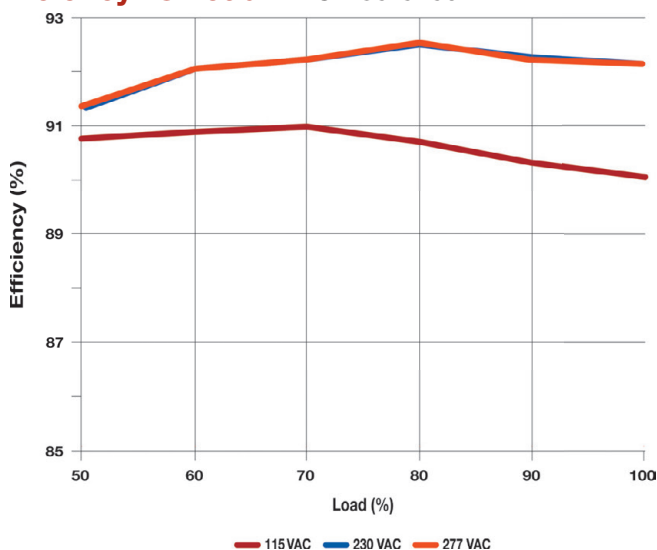

PFC vs Load: LDC-185-5250

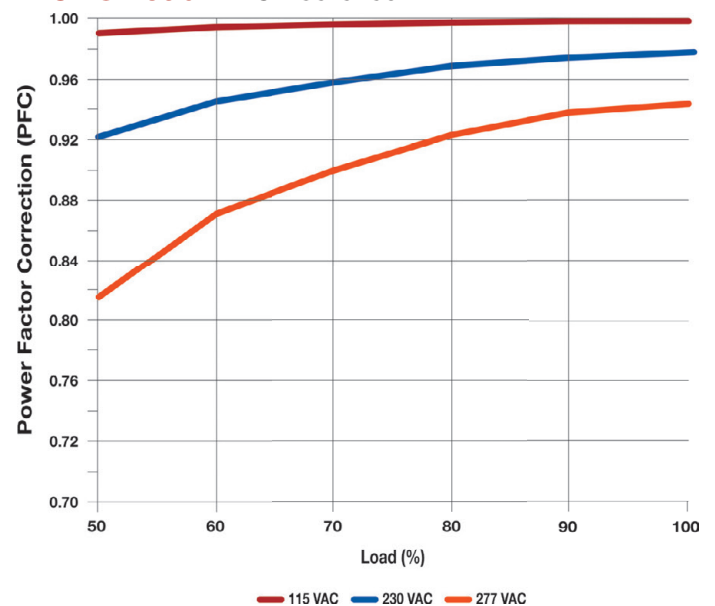

**Functional Block Diagram**

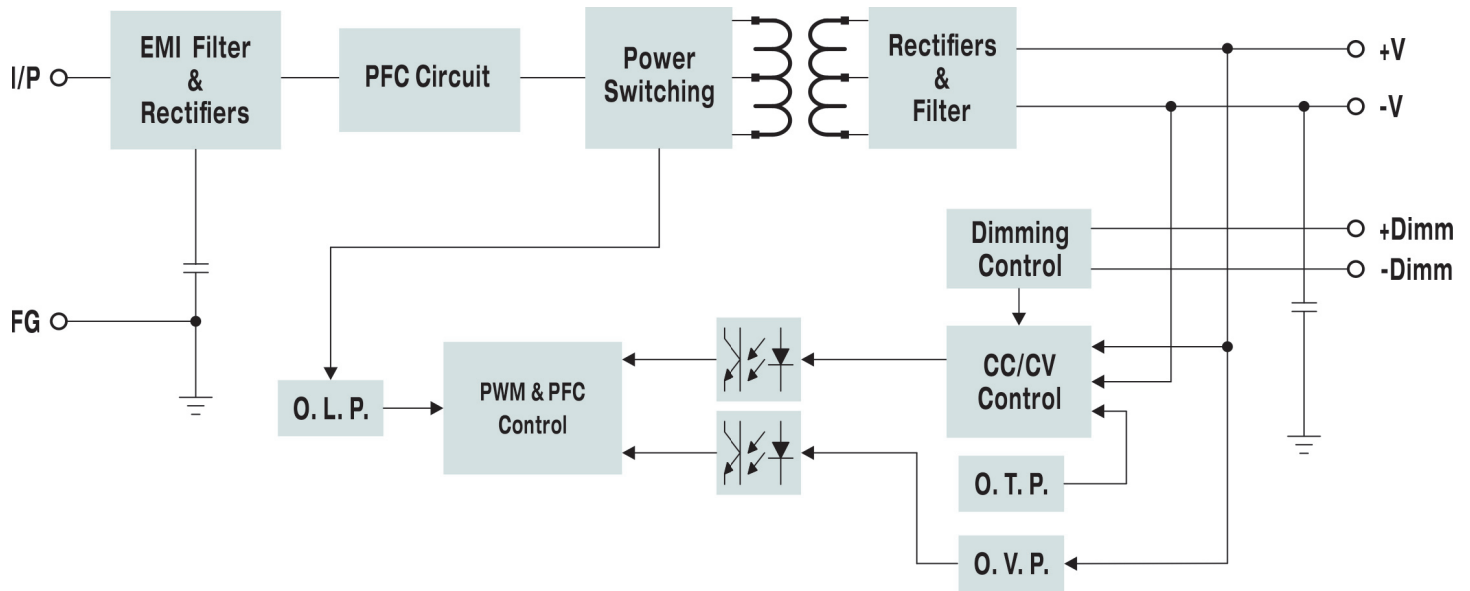

**Dimming Mode: B Model**

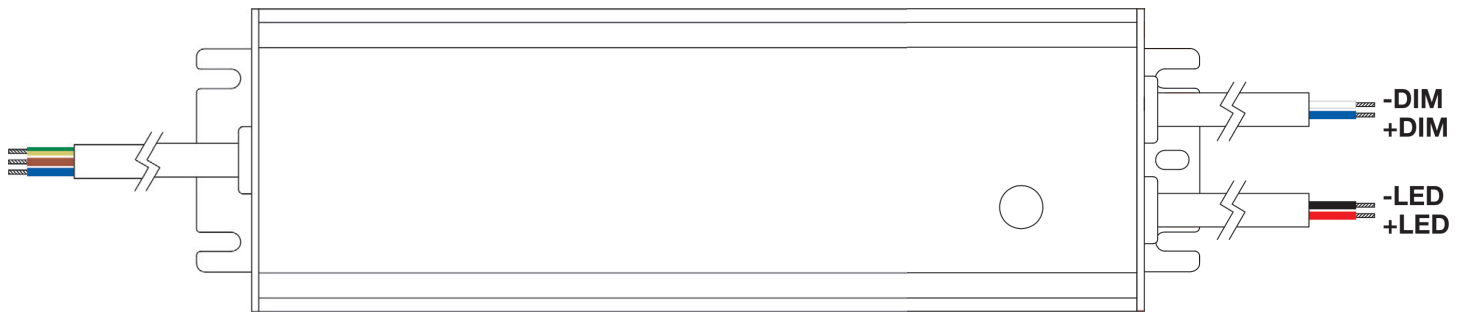

With the LDC-185 "B" model, the output current level can be adjusted (Dimmed) by three different methods; Resistive, Analog or Digital. Adjustments are made using the +DIM and -DIM inputs.

**Resistive:** Connect a 0.1 to 10 kΩ resistor between the DIM+ (Blue) and DIM- (White) wires

Input Frequency	10 kΩ	20 kΩ	30 kΩ	40 kΩ	50 kΩ	60 kΩ	70 kΩ	80 kΩ	90 kΩ	100 kΩ	Open
Percentage of Rated Current	10%	20%	30%	40%	50%	60%	70%	80%	90%	100%	95~105%

**Analog:** Apply 1 VDC to 10 VDC level between the DIM+ (Blue) and DIM- (White) wires

Adjust Voltage	1 VDC	2 VDC	3 VDC	4 VDC	5 VDC	6 VDC	7 VDC	8 VDC	9 VDC	10 VDC	Open
Percentage of Rated Current	10%	20%	30%	40%	50%	60%	70%	80%	90%	100%	95~105%

**Digital:** Apply a PWM signal (100 Hz - 3 kHz) between the DIM+ (Blue) and DIM- (White) wires

Duty Cycle	10%	20%	30%	40%	50%	60%	70%	80%	90%	100%	Open
Percentage of Rated Current	10%	20%	30%	40%	50%	60%	70%	80%	90%	100%	95~105%

**Notes:**

1. The -DIM (White) and -LED (Black) wires should not be connected.
2. The Dimming function will not turn the lighting fixture totally off. For more info on how to do this, please contact the factory

## Mechanical Dimensions: A Model

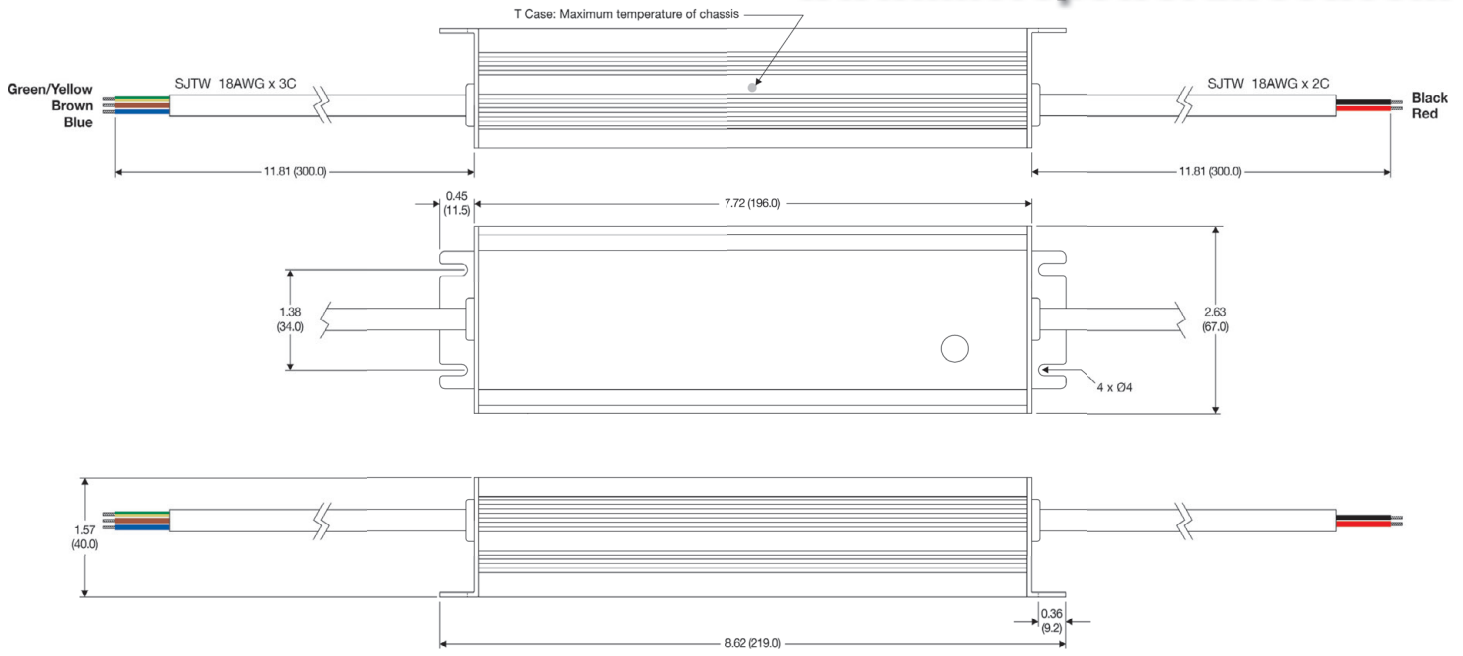

### Wire Connections: Input

Color	Function
Green/Yellow	Field Ground
Brown	AC-Line
Blue	AC-Neutral

### Wire Connections: Output

Color	Function
Black	-LED
Red	+LED

## Mechanical Dimensions: B Model (Dimming Function)

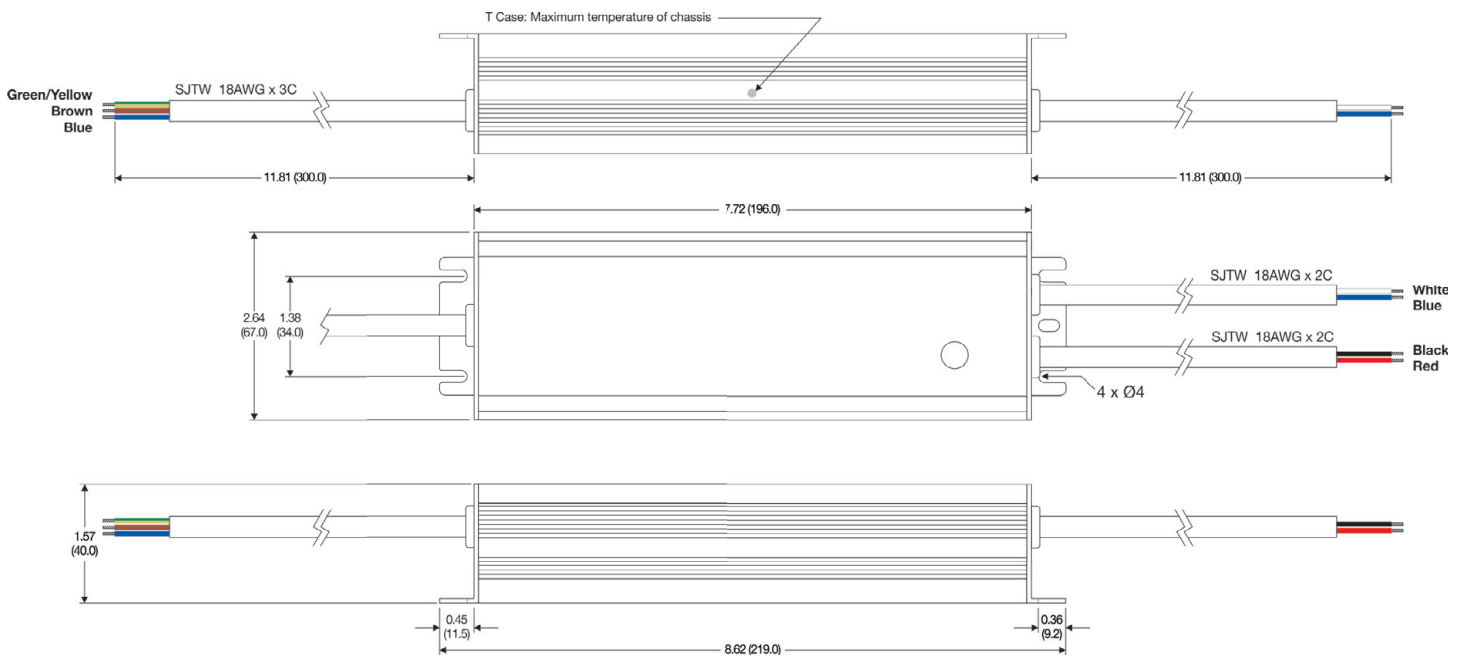

### Wire Connections: Input

Color	Function
Green/Yellow	Field Ground
Brown	AC-Line
Blue	AC-Neutral

### Wire Connections: Output

Color	Function
White	-DIM
Blue	+DIM
Black	-LED
Red	+LED



**MicroPower Direct**  
**We Power Your Success - For Less!**