

03 0322

Circular connectors with threaded joint M16 acc. to IEC 61076-2-106, IP40/IP67/IP68



Socket acc. to IEC 61076-2-106, IP 68, with threaded joint and solder terminals, 360° shielded

03 0322

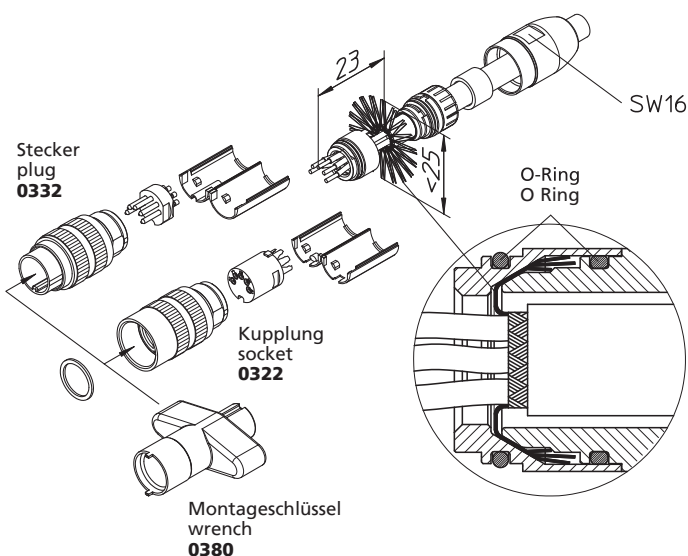
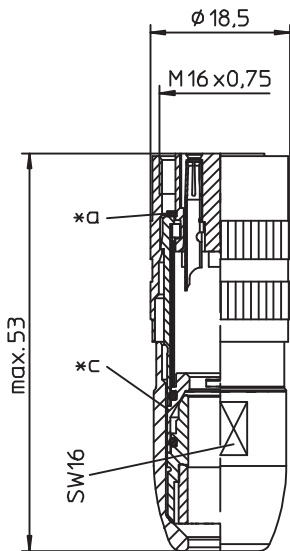

#### Environmental conditions

Temperature range -40 °C/+85 °C

#### Materials

Insulating body	PA GF, V-0 according to UL94
Contact bush	CuZn, silver-plated and flash gold-plated (3-8 poles) CuZn, pre-nickel and gold-plated (12-14 poles)
Housing	CuZn, nickel-plated
Knurled nut	CuZn, nickel-plated
Seal	NBR

#### Mechanical data

Insertion force/contact	$\leq 5.0 \text{ N}^1$
Withdrawal force/contact	$\geq 1.2 \text{ N}$ (3-8 poles) $\geq 0.9 \text{ N}$ (12-14 poles) <sup>1</sup>
Protection class	IP68 <sup>2</sup>

<sup>1</sup> measured with a polished steel pin, nominal thickness 1.5 mm (1.0 mm with 12-14 poles)

<sup>2</sup> according to IEC DIN EN 60529, only in locked condition with an appropriate counterpart; IPX8 requirements under agreement between manufacturer and user

#### Connectable conductors for solder area

Section	$\leq 0.75 \text{ mm}^2$ (AWG 20) (3-8 poles) $\leq 0.25 \text{ mm}^2$ (AWG 24) (12-14 poles)
Cable diameter	4–8 mm

#### Electrical data (at $T_{amb} 20 \text{ }^\circ\text{C}$ )

Contact resistance	$\leq 5 \text{ m}\Omega$
Rated current	5 A ( $T_{amb} 40 \text{ }^\circ\text{C}$ , 3-8 poles) 3 A ( $T_{amb} 40 \text{ }^\circ\text{C}$ , 12-14 poles)
Rated voltage	250 V (versions 03, 04, 05-1, 06, 07) 60 V (versions 05, 07-1, 08, 08-1, 12, 14)
Rated impulse voltage	2000 V (versions 03, 04, 05-1, 06, 07) 1000 V (versions 05, 07-1, 08, 08-1, 12, 14)
Insulation resistance	$> 100 \text{ M}\Omega$



**03-a**  
**0322 03**

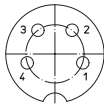

**04-a**  
**0322 04**

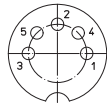

**05-b**  
**0322 05**

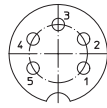

**05-a**  
**0322 05-1**

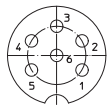

**06-a**  
**0322 06**

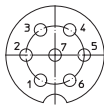

**07-a**  
**0322 07**

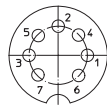

**07-b**  
**0322 07-1**

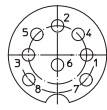

**0322 08**

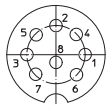

**08-a**  
**0322 08-1**



**12-a**  
**0322 12**

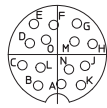

**14-a**  
**0322 14**

**Associated products**

Counterparts

☑ 0314	☑ 0314-1	☑ 0314-2
☑ 0315	☑ 0315-1	☑ 0315-1 U
☑ 0315-2	☑ 0316	☑ 0316-1
☑ 0316-2	☑ 0317	☑ 0317-1
☑ 0317-2	☑ 031798-1	☑ 031798-2
☑ 031799-2	☑ 0318	☑ 0318-1
☑ 0318-2	☑ 0331	☑ 0332
☑ 0332-1	☑ 033200	☑ 0365
☑ 036500		

Accessories

☑ 0322 C 16	☑ 0381	☑ 038199
☑ 038799		

\*a flat gasket

\*c shielding

03

0322

Designation	Pole Number	PU (Pieces)	MDQ (Pieces)
0322 03	3	50	100
0322 04	4	50	100
0322 05	5	50	100
0322 05-1	5	50	100
0322 06	6	50	100
0322 07	7	50	100
0322 07-1	7	50	100
0322 08	8	50	100
0322 08-1	8	50	100
0322 12	12	50	100
0322 14	14	50	100

**Packaging:**

sets of individual parts in plastic bags, in a cardboard box