

LC374TWN1-25G-A1

Features

With Stand-Offs

Applications

Advertising Signs
Indicators
LCD Backlight
Illumination Applications

Maximum Ratings (Ta=25°C)

Characteristic	Symbol	Max.	Unit
Forward Current	I _F	25	mA
Reverse Voltage	V _R	5	V
Power Dissipation	P _D	100.00	mW
Operating Temperature	T _{opr}	-40 ~ +95	°C
Storage Temperature	T _{stg}	-40 ~ +100	°C
Soldering Temperature	T _{sol}	260	°C
Soldering Time	-	for 3 sec. max	-

Opto-Electrical Characteristics (Ta=25°C)

Characteristic	Symbol	Test Condition	Min	Typ	Max	Unit
Forward Voltage	V _F	I _F =20mA	-	3.40	4.00	V
Reverse Current	I _R	V _R =5V	-	-	100	μA
Luminous Intensity	I _v	I _F =20mA	3000.00	3800.00	-	mcd
Viewing Angle	2θ ^{1/2}	-	-	30°	-	deg.
Peak Wavelength	λ _p	I _F =20mA	-	465	-	nm
Dominant Wavelength	λ _d	I _F =20mA	-	X=.31, Y=.32	-	nm
Spectral Line Half Width	Δλ	I _F =20mA	-	0	-	nm

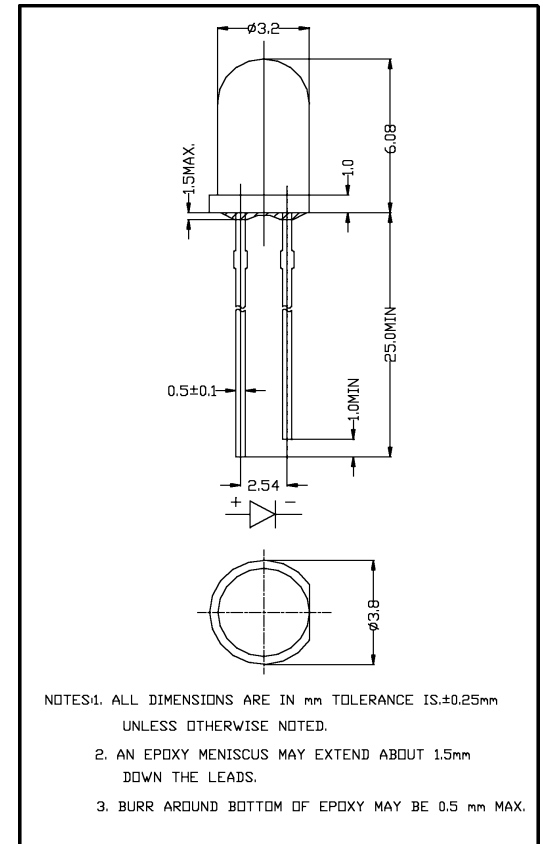

LC374TWN1-25G-A1 Graphs

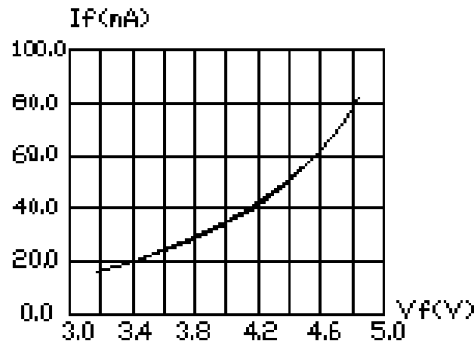

FIG.1 FORWARD CURRENT VS. FORWARD VOLTAGE

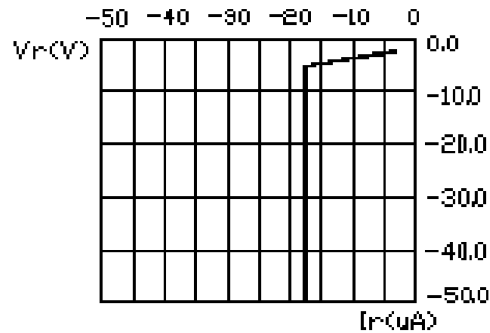

FIG.2 REVERSE CURRENT VS. REVERSE VOLTAGE

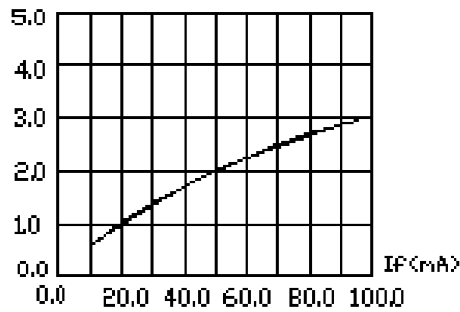

FIG.3 RELATIVE LUMINOUS INTENSITY VS. FORWARD CURRENT

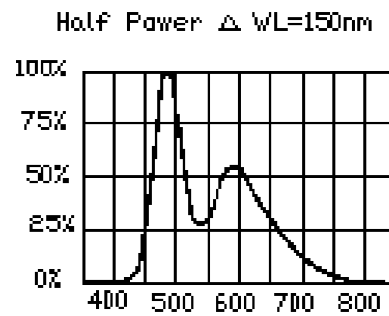

FIG.4 RELATIVE LUMINOUS INTENSITY VS. WAVELENGTH.

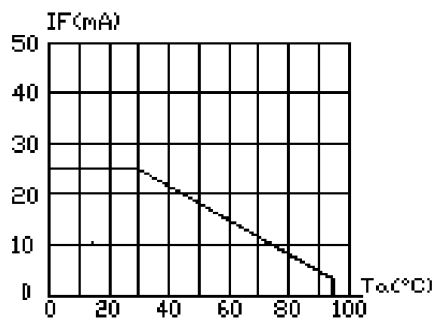

FIG.5 MAXIMUM FORWARD CURRENT VS. AMBIENT TEMPERATURE (Tjmax=105°C)

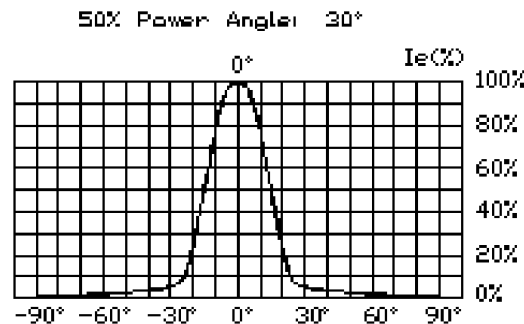

FIG.6 FAR FIELD PATTERN