

# RECTIFIERS

## High Efficiency, 2.5A

UES1101 BYV27-50  
 UES1102 BYV27-100  
 UES1103 BYV27-150

**2**

### FEATURES

- Very Fast Recovery Times
- Very Low Forward Voltage
- Small Size
- Convenient Package

### DESCRIPTION

An axial leaded power rectifier useful in many switching applications. Particularly suited where very fast recovery and low forward voltage are required.

### ABSOLUTE MAXIMUM RATINGS

	UES1101	UES1102	UES1103	BYV27-50	BYV27-100	BYV27-150
Peak Inverse Voltage, $V_R$	50V	100V	150V	50V	100V	150V
Maximum Average D.C. Output at $T_L = 75^\circ\text{C}$ , $L = \frac{3}{8}"$ , $I_o$	2.5A	2.5A	2.5A	2.5A	2.0A	2.0A
Non-Repetitive Surge Current at 8.3ms, $I_{FSM}$	35A	35A	35A	35A	50A	50A
Thermal Resistance at $L = \frac{3}{8}"$ , $R_{\theta JC}$	38°C/W	38°C/W	38°C/W	38°C/W	46°C/W	46°C/W
Junction Operating Temperature, $T_J$	175°C	175°C	175°C	175°C	165°C	165°C
Operating and Storage Temperature Range	-55°C to +175°C					

### ELECTRICAL SPECIFICATIONS

Type	Maximum Reverse Voltage $V_R$	Maximum Forward Voltage @		Maximum Reverse Current @ Rated $V_R$		Maximum Reverse Recovery Time*
		$T_J = 25^\circ\text{C}$	$T_J = 100^\circ\text{C}$	$T_J = 25^\circ\text{C}$	$T_J = 100^\circ\text{C}$	
UES1101 UES1102 UES1103	50V 100V 150V	.975V @ 2A	.895V @ 2A	2 $\mu\text{A}$	50 $\mu\text{A}$	25nS
BYV27-50 BYV27-100 BYV27-150	50V 100V 150V	1.25V @ 5A	.85V @ 2.5A	1 $\mu\text{A}$	150 $\mu\text{A}$	25nS

\*Measured in circuit  $I_F = \frac{1}{2}A$ ,  $I_R = 1.0A$ ,  $I_{REC} = \frac{1}{2}A$

### MECHANICAL SPECIFICATIONS

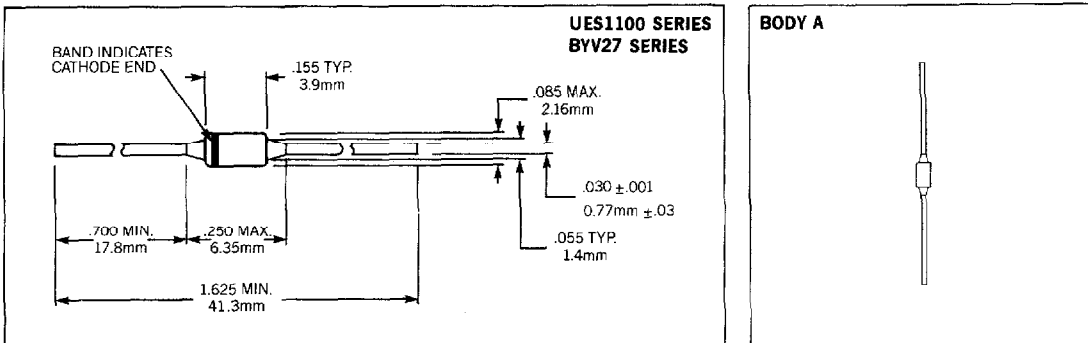

THESE DEVICES ALSO AVAILABLE IN SURFACE MOUNT PACKAGE. SEE SECTION 10

**Microsemi Corp.**  
**Watertown**  
 The diode experts

**Output Current vs. Lead Temperature**

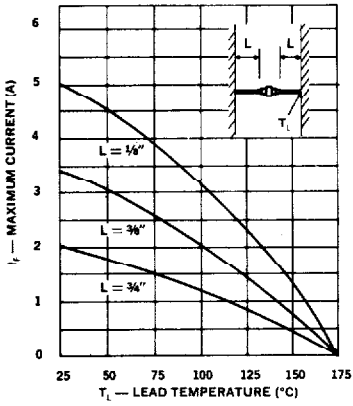

**Typical Forward Current vs. Forward Voltage**

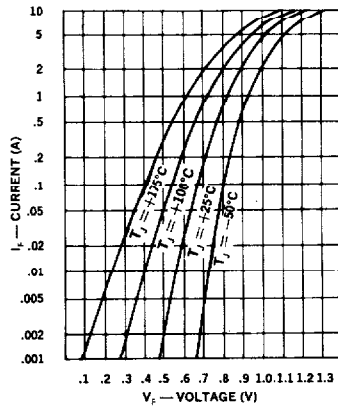

**Typical Reverse Current vs. Voltage**

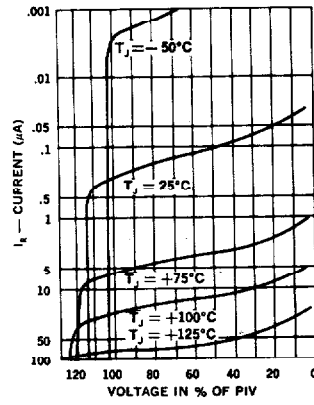

**Forward Pulse Current vs. Duration**

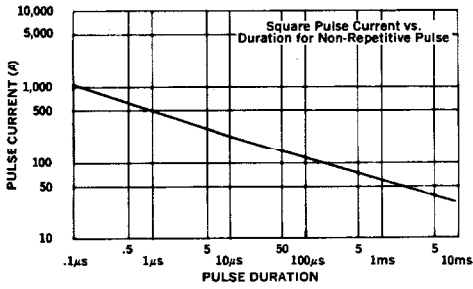

**Multiple Surge Current vs. Duration**

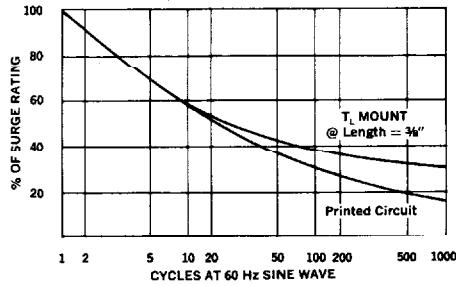

**Reverse-Recovery Circuit**

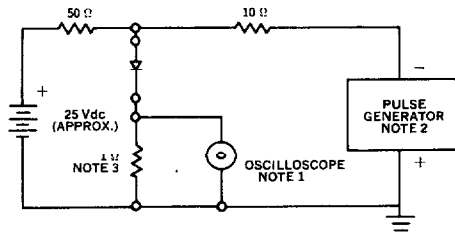

- Notes:**
1. Oscilloscope: Rise time  $\leq 3\text{nS}$ ; input impedance =  $50\Omega$ .
  2. Pulse Generator: Rise time  $\leq 8\text{nS}$ ; source impedance  $10\Omega$ .
  3. Current viewing resistor, non-inductive, coaxial recommended.