



AND-TFT-35VX-KIT

3.5" TFT LCD

LCD Color Monitor

The AND-TFT-35VX-KIT is a compact full color TFT LCD module, that is suitable for security, video games, door phones, video phones, portable TV and instrument displays and other media applications which require a high quality flat panel display. This device consists of an amorphous silicon TFT LCD panel with LED B/L that has 640 x 480 pixels on a 3.5 inch diagonal screen.

Product specifications contained herein may be changed without prior notice. It is therefore advisable to contact Purdy Electronics before proceeding with the design of equipment incorporating this product.

Features

- Amorphous silicon TFT LCD panel with LED B/L
- Module with resistive type touch panel
- Pixel in stripe configuration
- High Resolution: 262,144 Dots (640 x 480)
- Optimum viewing direction: 6 o'clock
- Auto-detect input signal when power on
- Input Signal: D-Sub VGA Signal, Dual Composite Video Channels and S-Video
- Operating Temperature: 0°C ~ 60°C
- Storage Temperature: -20°C ~ 80°C
- **RoHS Compliant**

Part List

- AND-TFT-35VX
- PC-TFT-35VX
- 6 Button OSD board with cable
- User interface board with cable

Mechanical Characteristics

Item	Specification	Unit
Screen Size	3.5 inch diagonal	inch
Display Format	640 x (R, G, B) x 480	dot
Display Colors	262,144	-
Active Area	72 (W) x 52.56 (H)	mm
Pixel Pitch	0.1125 (W) x 0.1095 (H)	mm
Pixel Configuration	Stripe	-
Outline Dimension	84.25 (W) x 65.40 (H) x 4.45 (D) (Typ.)	mm
Weight	52 ± 5	g
Surface Treatment	AG	-
Surface Treatment of Touch Panel	3H	-

Absolute Maximum Rating VSS1 = VSS2 = GND = JV, Ta=25°C

Item	Symbol	Remark	Min.	Max.	Unit
Supply Voltage	V _{DD1}	-	-0.3	2	V
	V _{CC}	-	-0.3	5	V
	V _{DD2}	-	-0.5	12.0	V
	V _{GG}	-	-0.3	40.0	V
	V _{GG} -V _{EE}	-	-	40.0	V
	V _{EE}	-	-20	0.3	V
Storage Temperature	T _{ST}	-	-20	+80	°C
Operation Temperature	T _{OP}	Note 1	0	+60	°C

Note 1: Operating Temperature defines that contrast, response time, other display optical character are Ta=+25.



Power Consumption

Item	Symbol	Conditions	Specifications		Units
			Typ.	Max.	
Supply Current for Gate Driver (Hi level)	I_{GG}	$V_{GG}=+17V$	0.12	0.15	mA
Supply Current for Gate Drive (Low level)	I_{EE}	$V_{EE}=-10V$	0.15	0.19	mA
Supply Current for Source Driver (Digital)	I_{DD1}	$V_{DD1}=+3.3V$	4.8	8.0	mA
Supply Current for Source Driver (Analog)	I_{DD2}	$V_{DD2}=+10V$	16.0	30.0	mA
Supply Current for Gate Driver (Digital)	I_{CC}	$V_{CC}=+3.3V$	0.17	0.21	mA
LCD Panel Power Consumption	-	-	180	332	mW
Backlight Power Consumption	P_{LED}	-	384	456	mW
Total Power Consumption	-	-	564	788	mW

Recommended Operating Conditions (VSS1 = VSS2 = GND = 0V, Ta = 25°C)

Item	Symbol	Specifications			Unit
		Min.	Typ.	Max.	
Supply Voltage for Source Driver	V_{DD1}	3.0	3.3	3.6	V
	V_{DD2}	9.5	10	10.5	V
Supply Voltage for Gate Driver	V_{GG}	-	+17	-	V
	V_{EE}	-	-10	-	V
	V_{CC}	3.0	3.3	3.6	V
Digital Input Voltage	V_{IH}	$0.8 V_{DD1}$	-	V_{DD1}	V
	V_{IL}	0	-	$0.2 V_{DD1}$	V

Recommended Driving Conditions for LED Backlight (GND= 0V, Ta=25°C)

Item	Symbol	Min.	Typ.	Max.	Unit	Remarks
Supply Voltage of LED Backlight	V_{LED}	9	9.6	11.4	V	$I_L = 20MA$
Supply Current of LED Backlight	I_{LED1}	-	20	-	mA	Note 1
	I_{LED2}					
Backlight Power Consumption	P_{LED}	360	384	456	mW	Note 2

Note 1: LED B/L applied information, please refer to the appendix at the end.

Note 2: $P_{LED} = V_{LED} * I_{LED1} + V_{LED} * I_{LED2}$.



Optical Specifications (Ta=25°C)

Item		Symbol	Conditions	Specifications			Unit
				Min.	Typ.	Max.	
Viewing Angle	Horizontal	θ	CR>10	± 45	± 50	-	deg
	Vertical	θ (to 12 o'clock)		10	15	-	
		θ (to 6 o'clock)		30	35	-	
Contrast Ratio Luminance when LCD is White Luminance when LCD is Black		CR	-	200	400	-	-
Response Time	Rise	Tr	$\theta = 0^\circ$	-	15	30	ms
	Fall	Tf		-	25	50	
Brightness		LUM	$\theta = 0^\circ$	180	210	-	cd/m ²
Uniformity		U	$\theta = 0^\circ$	70	75	-	%
Cross Talk		-	$\theta = 0^\circ$	-	-	3	%
White Chromaticity		X	-	0.28	0.31	0.34	-
		Y		0.30	0.33	0.36	
Lamp Life Time	Ta=25°C	-	-	-	10,000	-	hrs

Electronic Characteristics

Symbol	I/O	Conditions	Min.	Typ.	Max.	Unit
V in	I	DC(+)	4.8	5	5.2	V
I in		DC(+5V)	400	450	500	mA
P in			2.25			W

Touch Panel Characteristics - Electrical Performance

Item	Symbol	Min.	Typ.	Max.	Unit	Remark
Terminal Resistance	X	120	240	370	Ω	
	Y	280	570	860	Ω	
Input Voltage	VT	-	5.0	7.0	V	
Linearity (X, Y direction)		20		±1.5	%	
Insulation Impedance		20			M Ω	DC25V
Response Time				5	ms	
Operation Force				35	g	Note 1

Note 1: Input through 0.8R stylus or finger.

Touch Panel Characteristics - Durability Performance

Hitting Durability	At least 1,000,000 times with 48.0mm silicon rubber, 200g, 3 times/second.
Sliding Durability	At least 1,000,000 times with r0.8mm polyacetal stylus, 200g, 60mm/second.

Pixel Arrangement - The LCD module pixel arrangement is stripe.

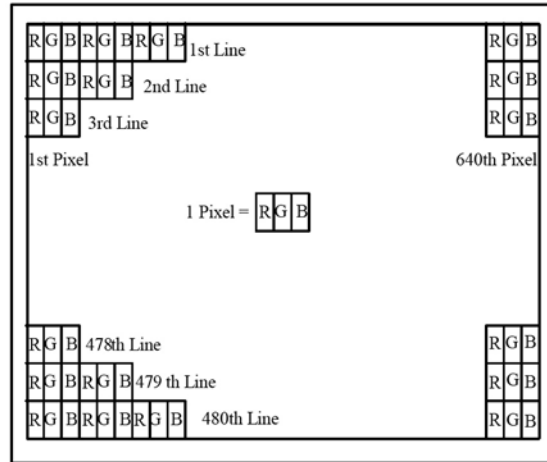

Driver Board Outline Drawing

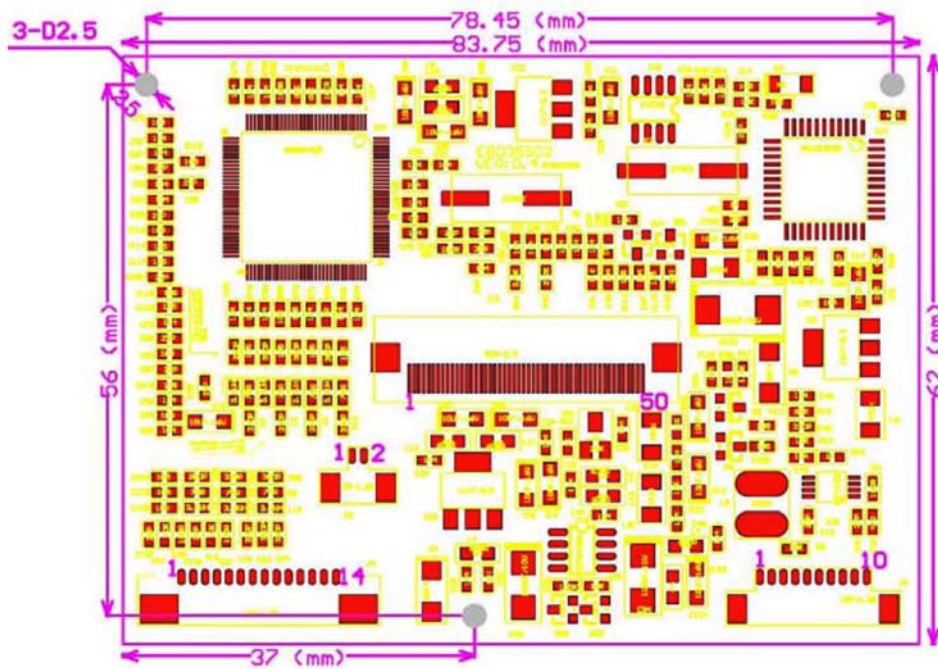

Description:

- Outline:** 83.75 x 62 x 7.2 mm
- Top Layer High (Max):** 6 mm
- Board thickness:** 1.2 mm
- Three Screw Holes:** Φ 2.5 mm

Keyboard Outline Drawing (Optional)

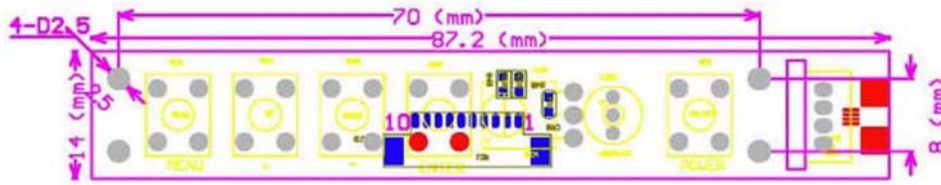

Description:

Outline: 87.2 x 14 x 12.7 mm

Top Layer High (Max): 8 mm

Bottom Layer High (Max): 3.5 mm

Board thickness: 1.2 mm

Four Screw Holes: Φ 2.5 mm

Demo Kit Outline Drawing (Optional)

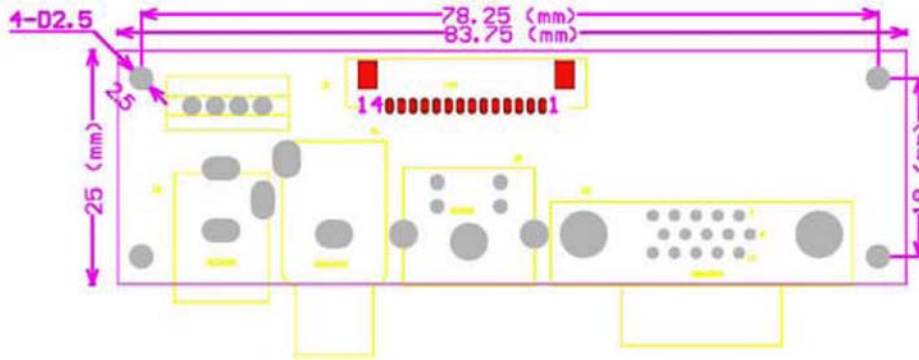

Description:

Outline: 83.75 x 25 x 19.7 mm

Top Layer High (Max): 15 mm

Bottom Layer High (Max): 3.5 mm

Board thickness: 1.2 mm

Four Screw Holes: Φ 2.5 mm



Input/Output Terminals

- J12 Output to Panel Signal Terminal (50FPC)
- J4 Outside Signal Input Terminal (14 pin)
- J5 Control Signal Input Terminal (10 pin)
- J3 Video 2 Input Terminal (2 pin) (Optional)
- J4 Outside Signal Input Terminal
Connector: Molex 53261-1471 or Compatible

Pin No.	Pin Name	I/O	Pin Description	Remarks
1	GND	I	Ground	-
2	VSYNC	I	VSYNC input for RGB input	-
3	HSYNC	I	HSYNC input for RGB input	-
4	GND	I	Ground	-
5	B	I	Video BLUE input	-
6	G	I	Video GREEN input	-
7	R	I	Video RED input	-
8	GND	I	Ground	-
9	S-C	I	S-video Chroma input	-
10	S-Y	I	S-video luma input	-
11	VIDEO1	I	Composite Video 1	-
12	GND	I	Ground	-
13	GND	I	Ground	-
14	V _{CC}	I	5V	4.8V – 5.2V

- J5 Control Signal Input/Output Terminal
Connector: Molex 53261-1071 or Compatibility

Pin No.	Pin Name	I/O	Pin Description	Remarks
1	LED	O	Red Lamp	-
2	LED	O	Green Lamp	-
3	SENSOR	I	Remote Sensor	-
4	GND	I	Ground	-
5	3.3V	O	+3.3V	-
6	ON/OFF	I	Power On/Off	-
7	MENU	I	Menu	-
8	DOWN	I	Down	-
9	UP	I	Up	-
10	ENTER	I	Enter	-

- J5 Control Signal Input/Output Terminal
Connector: Molex 53261-1071 or Compatibility

Pin No.	Pin Name	I/O	Pin Description	Remarks
1	GND	I	Ground	-
2	VIDEO2	I	Composite Video 2	-

Dimensional Outline

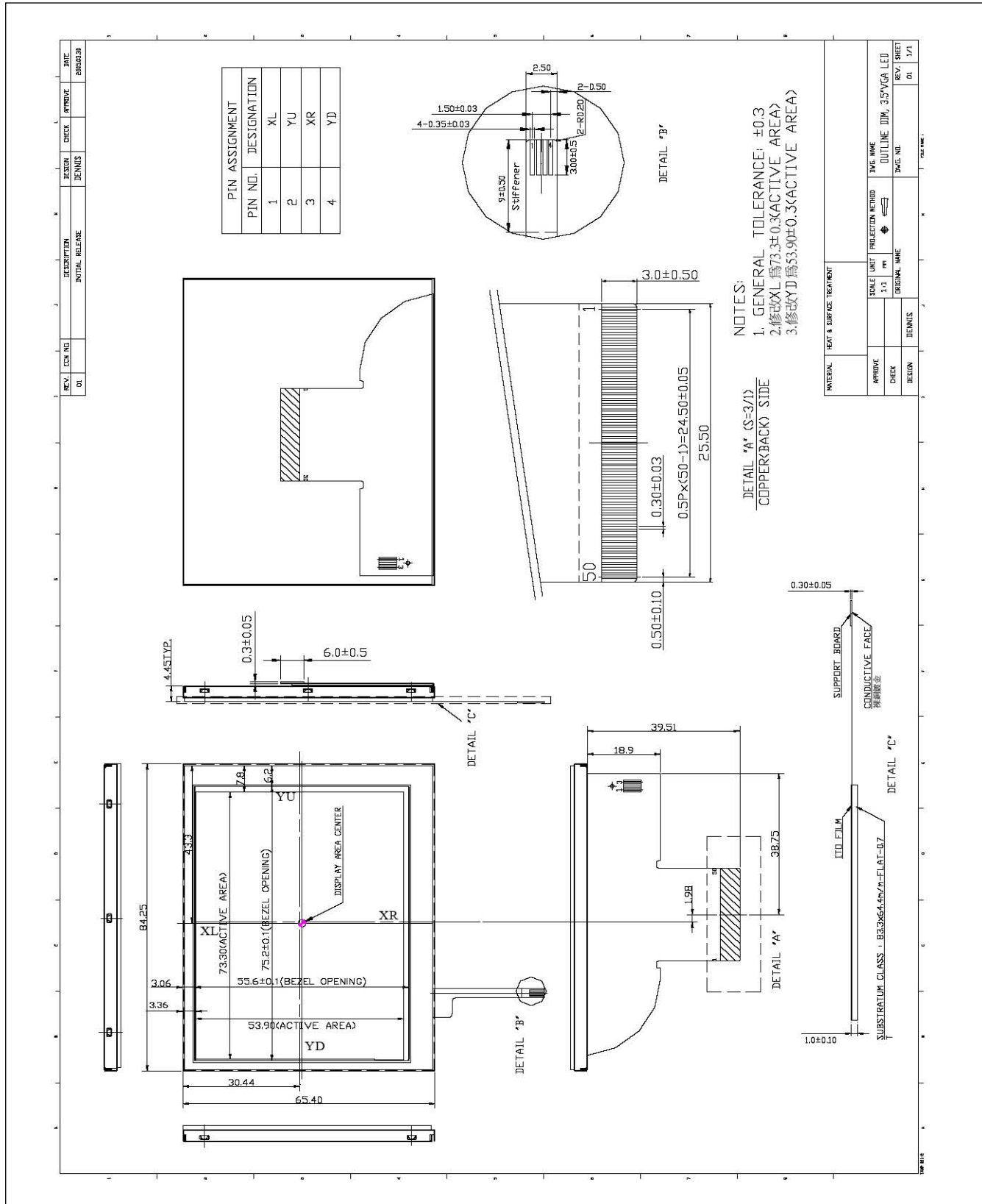

**Timing Parameters - AC Electrical Characteristics** (VCC=VDD1=3.3V, VDD2 = 10V, GND = VSS1 = VSS2 = 0V, Ta=25°C)

Item	Symbol	Min.	Typ.	Max.	Unit
CLK Frequency	F _{CLK}	–	25	40	MHz
CLK Pulse Width	T _{CPH}	25	–	–	ns
Data Set-up Time	T _{SU}	4	–	–	ns
Data Hold Time	T _{HD}	2	–	–	ns
Propagation Delay of DIO2/1	T _{PHL}	6	10	15	ns
Time That The Last Data to LD	T _{LD}	1	–	–	T _{CPH}
Pulse Width of LD	T _{WLD}	2	–	–	T _{CPH}
Time That LD to DIO1/2	T _{LDS}	5	–	–	T _{CPH}
POL Set-up Time	T _{PSU}	6	–	–	ns
POL Hold Time	T _{PHD}	6	–	–	ns
OE Pulse Width	T _{OEV}	1	–	–	μs
CKV Pulse Width	T _{CKV}	500	–	–	ns
STV Set-up Time	T _{SUV}	400	–	–	ns
STV Hold Time	T _{HDV}	400	–	–	ns
Horizontal Display Period	T _{HDP}	–	640	–	T _{CPH}
Horizontal Period Timing Range	T _{HP}	–	800	–	T _{CPH}
Horizontal Lines Per Field	T _V	520	525	640	T _{HP}
Vertical Display Timing Range	T _{DV}	–	480	–	T _{HP}

Interface Board

Features

- Used for TFT-LCD Display: 3.5" AND-TFT-35VX
- Auto-detect input signal when power on
- Input Signal: D-Sub VGA Signal, Dual Composite Video Channels and S-Video
- Operating Temperature: 0°C ~ 60°C
- Storage Temperature: -20°C ~ 80°C
- **RoHS Compliant**

The PC-TFT-35VX interface board is designed to work with the **AND-TFT-35VX** color TFT 3.5" display and together is suitable for security, video games, door phone, video phone, portable TV, and instrument display applications.

Electronic Characteristics

Symbol	I/O	Conditions	Min.	Typ.	Max.	Unit
V in	I	DC(+)	4.8	5	5.2	V
I in		DC(+5V)	400	450	500	mA
P in			2.25			W

Driver Board Outline Drawing

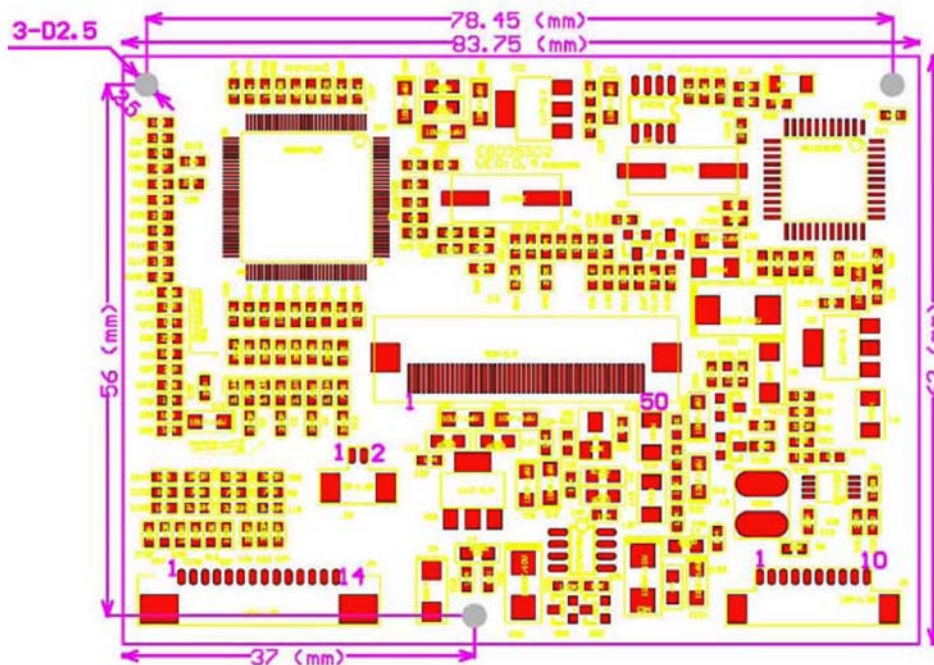

Description:

Outline: 83.75 x 62 x 7.2 mm

Top Layer High (Max): 6 mm

Board thickness: 1.2 mm

Three Screw Holes: Φ 2.5 mm

**Input/Output Terminals**

- J12** Output to Panel Signal Terminal (50FPC)
- J4** Outside Signal Input Terminal (14 pin), Connector: Molex 53261-1471
- J3** Video2 Input Terminal (2 pin) optional
- J5** Control Signal Input Terminal (10 pin), Molex 53261-1071

Pin No.	Pin Name	I/O	Pin Description	Remarks
1	GND	I	Ground	-
2	VSYNC	I	VSYNC input for RGB input	-
3	HSYNC	I	HSYNC input for RGB input	-
4	GND	I	Ground	-
5	B	I	Video BLUE input	-
6	G	I	Video GREEN input	-
7	R	I	Video RED input	-
8	GND	I	Ground	-
9	S-C	I	S-video Chroma input	-
10	S-Y	I	S-video luma input	-
11	VIDEO1	I	Composite Video 1	-
12	GND	I	Ground	-
13	GND	I	Ground	-
14	V _{CC}	I	5V	4.8V – 5.2V

- J5** Control Signal Input/Output Terminal
Connector: Molex 53261-1071 or Compatibility

Pin No.	Pin Name	I/O	Pin Description	Remarks
1	LED	O	Red Lamp	-
2	LED	O	Green Lamp	-
3	SENSOR	I	Remote Sensor	-
4	GND	I	Ground	-
5	3.3V	O	+3.3V	-
6	ON/OFF	I	Power On/Off	-
7	MENU	I	Menu	-
8	DOWN	I	Down	-
9	UP	I	Up	-
10	ENTER	I	Enter	-

- J3** VIDEO2 Input Terminal (Optional)
Connector: Molex 53261-0271 or compatible

Pin No.	Pin Name	I/O	Pin Description	Remarks
1	GND	I	Ground	-
2	VIDEO2	I	Composite Video2	-

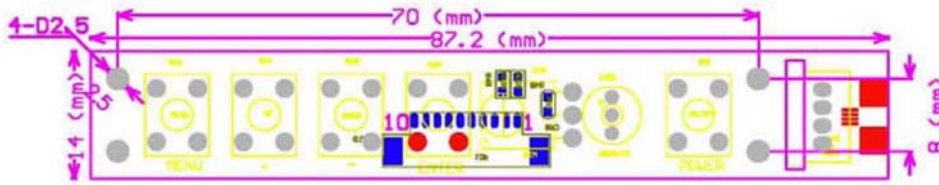
Keyboard Outline Drawing (Optional)

Description:
Outline: 87.2 x 14 x 12.7 mm

Top Layer High (Max): 8 mm

Bottom Layer High (Max): 3.5 mm

Board thickness: 1.2 mm

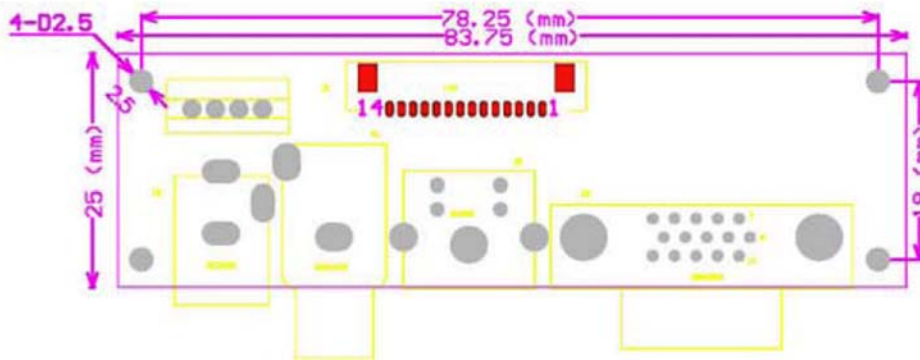
Four Screw Holes: Φ 2.5 mm

I/O Outline Drawing (Optional)

Description:
Outline: 83.75 x 25 x 19.7 mm

Top Layer High (Max): 15 mm

Bottom Layer High (Max): 3.5 mm

Board thickness: 1.2 mm

Four Screw Holes: Φ 2.5 mm



AND-TFT-35VX-KIT

Item List: Driver Board & Cable for Demo Kit

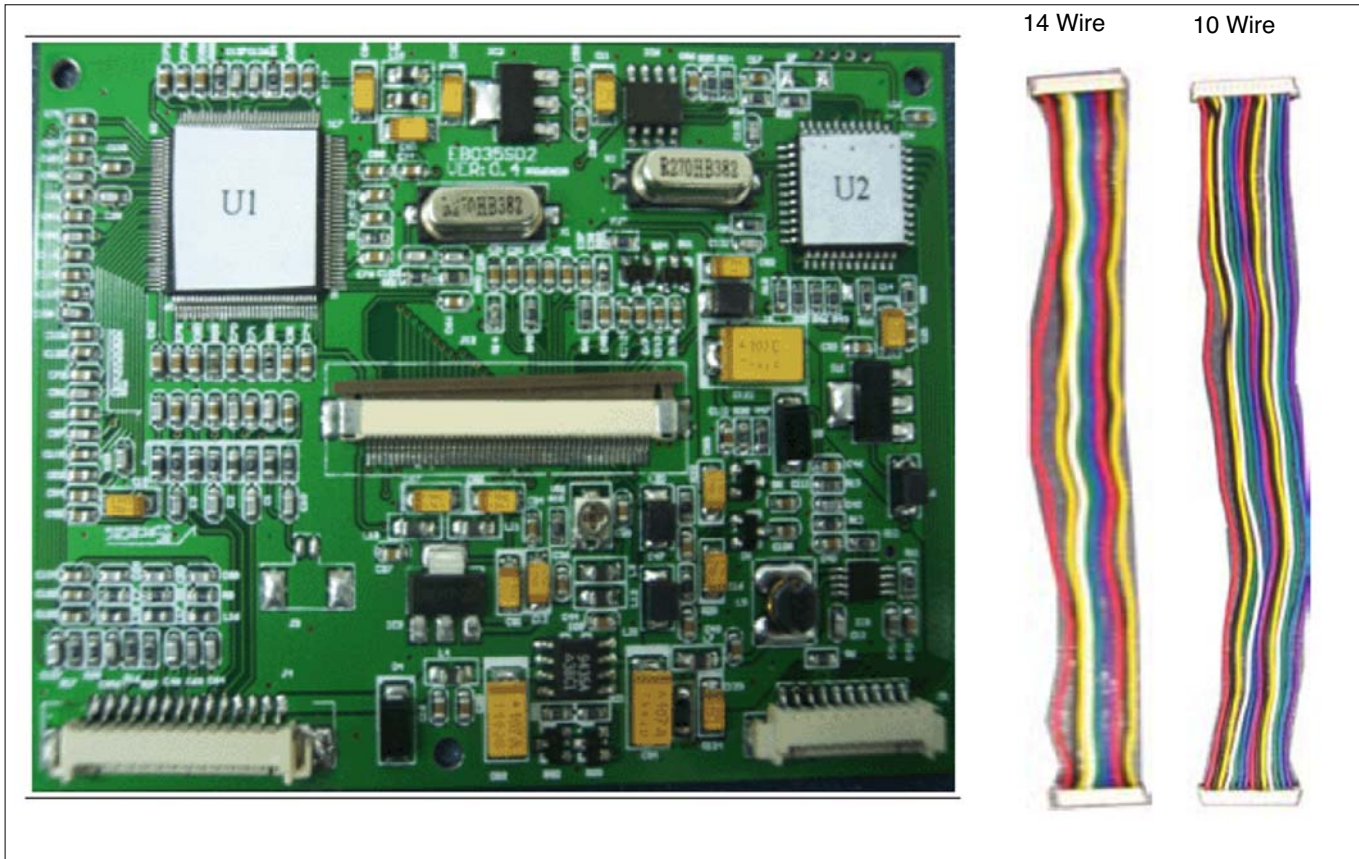

Keyboard

Name	Location	Function
Power	SW1	On/Off
Lamp	LED	Indicator
Sensor	IC1	Optional
Enter	SW2	Select
Down	SW3	Decrement
Up	SW4	Increment
Menu	SW5	Brightness, Contrast, Color, Tint, Sharpness

Item List: Driver Board & Cable for Demo Kit

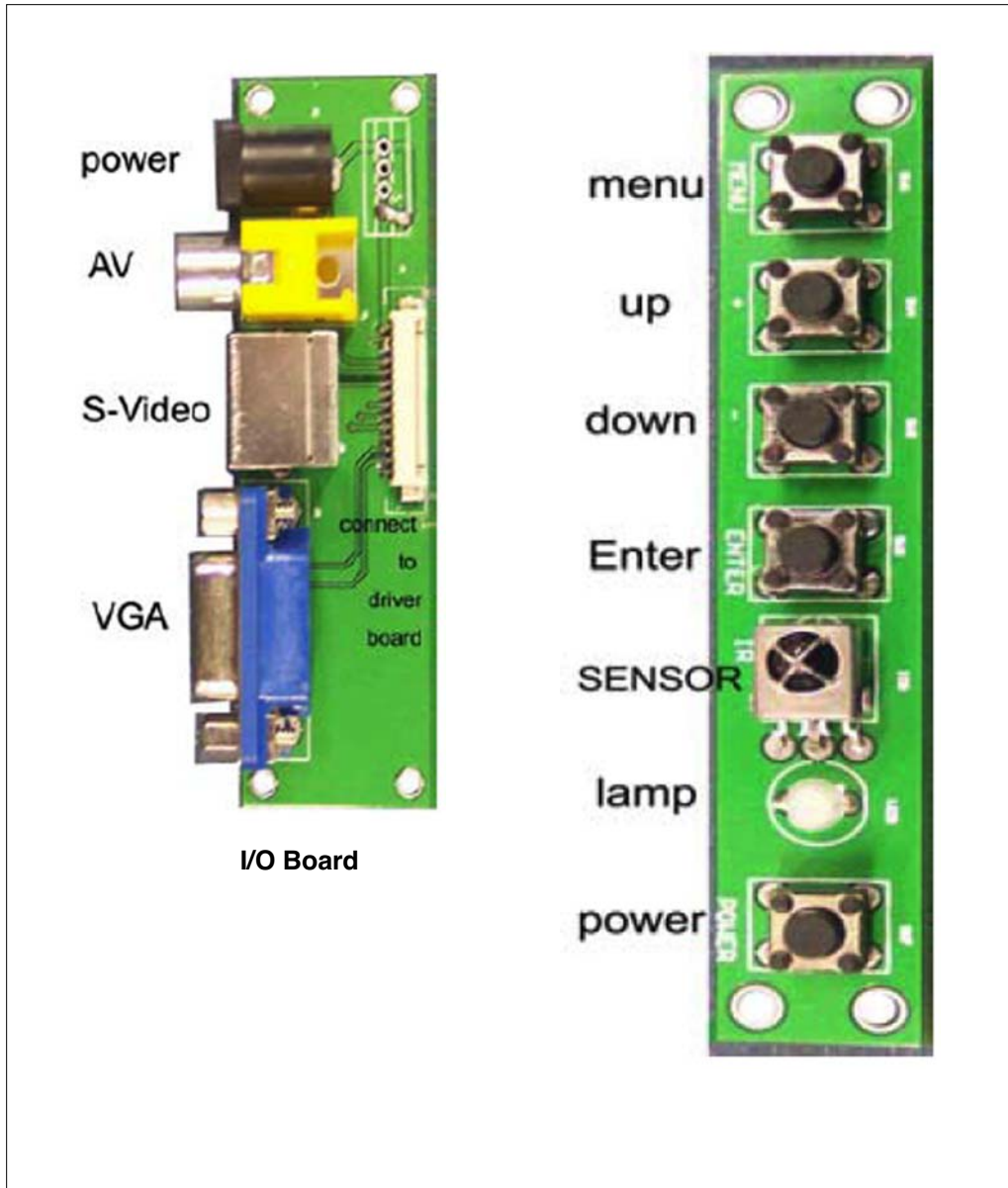

I/O Board

Connector	Description
Power (J6)	(- + +5V center pin)
AV (J7)	RCA jack (signal center pin)
S-Video (J8)	Optional
VGA (J2)	DB15 (PC Input)
Interface (J1)	14 wire Interface