

NON-ISOLATED DC/DC CONVERTERS

2.4 Vdc - 5.5 Vdc Input, 0.6 Vdc - 3.63 Vdc /20 A Output



December 2, 2010

Bel Power Inc., a subsidiary of Bel Fuse Inc.

SLIN-20F1Ax

RoHS Compliant

Rev.B

Features

- Wide Input Voltage Range
- Output Voltage Programmable
- Fixed Switching Frequency
- Remote On/Off
- Remote Sense
- Tunable Loop™ (a registered trademark of Lineage Power Systems) to Optimize Dynamic output voltage response
- Class 1, Category 2, Non-Isolated DC/DC Converter (refer to IPC-9592)
- Compliant to RoHS EU Directive 2002/95/EC
- UL* 60950-1 Recognized, CSA† C22.2 No. 60950-1-03 Certified
- VDE‡ 0805:2004-09 (EN60950-1) Licensed
- Flexible Output Voltage Sequencing
- Over Temperature Protection
- Output Over Current Protection
- Ability to Sink and Source Current
- Cost Efficient Open Frame Design

Applications

- Distributed power architectures
- Intermediate bus voltage applications
- Telecommunications equipment
- Servers and storage applications
- Networking equipment
- Industrial equipment



Description

The SLIN-20F1Ax series of power modules are non-isolated dc/dc converters that can deliver up to 20A of output current. These modules operate over a wide range of input voltage ($V_{IN} = 2.4Vdc-5.5Vdc$) and provide a precisely regulated output voltage from 0.6Vdc to 3.63Vdc, programmable via an external resistor. Features include remote On/Off, adjustable output voltage, over current and over temperature protection, and output voltage sequencing. A new feature, the Tunable Loop™, allows the user to optimize the dynamic response of the converter to match the load with reduced amount of output capacitance leading to savings on cost and PWB area.

Part Selection

Output Voltage	Input Voltage	Max. Output Current	Typical Efficiency	Model Number Active High	Model Number Active Low
0.6 Vdc - 3.63 Vdc	2.4 Vdc - 5.5 Vdc	20 A	90.8%	SLIN-20F1A0	SLIN-20F1AL

Notes: Add "G" suffix at the end of the model number to indicate Tray Packaging.

Part Number Explanation

S **LIN** - **20** **F** **1A** **0**
 1 2 3 4 5 6

1---Surface mount

2---Series code

3---Output current (20A)

4--- Wide input voltage range (2.4-5.5V)

5--- Wide output voltage range (0.6-3.63V)

6--- Enable, active high, change "0" to "L" means active low

NON-ISOLATED DC/DC CONVERTERS

2.4 Vdc - 5.5 Vdc Input, 0.6 Vdc - 3.63 Vdc /20 A Output



December 2, 2010

Bel Power Inc., a subsidiary of Bel Fuse Inc.

Absolute Maximum Ratings

Parameter	Min	Typ	Max	Unit	Notes
Continuous Input Voltage	-0.3	-	6	V	
Sequencing Voltage	-0.3	-	V _{in,max}	V	
Operating Ambient Temperature	-40	-	85	°C	
Storage Temperature	-55	-	125	°C	

Note: Stresses in excess of the absolute maximum ratings can cause permanent damage to the device. These are absolute stress ratings only, functional operation of the device is not implied at these or any other conditions in excess of those given in the operations sections of the data sheet. Exposure to absolute maximum ratings for extended periods can adversely affect the device reliability.

Input Specifications

Parameter	Min	Typ	Max	Unit	Notes
Operating Input Voltage	2.4	-	5.5	V	
Input Current (full load)	-	-	19.5	A	V _{IN} =2.4V to 5.5V, I _O =I _{O,max}
Input Current (no load)	-	47	-	mA	V _{IN} =5.0V, V _O =0.6V, I _O =0, module enabled
	-	52	-	mA	V _{IN} =5.0V, V _O =3.3V, I _O =0, module enabled
Input Stand-by Current	-	5	-	mA	V _{IN} = 5V, module disabled
Input Reflected Ripple Current (pk-pk)	-	12	-	mA	5Hz to 20MHz, 1μH source impedance; V _{IN} =0 to 5.5V, I _O = I _{O,max}
I ² t Inrush Current Transient	-	-	1	A ² s	
Input Ripple Rejection (120Hz)	-	43	-	dB	
Turn-on Threshold	-	2.2	-	V	
Turn-off Threshold	-	2.0	-	V	
Hysteresis	0.08	-	0.2	V	

CAUTION: This converter is not internally fused. An input line fuse must be used in application.

This power module can be used in a wide variety of applications, ranging from simple standalone operation to an integrated part of sophisticated power architecture. To preserve maximum flexibility, internal fusing is not included; however, to achieve maximum safety and system protection, always use an input line fuse. The safety agencies require a fast-acting fuse with a maximum rating of 20A. Based on the information provided in this data sheet on inrush energy and maximum dc input current, the same type of fuse with a lower rating can be used. Refer to the fuse manufacturer's data sheet for further information.

Note: Unless otherwise indicated, specifications apply over all operating input voltage, resistive load, and temperature conditions.

NON-ISOLATED DC/DC CONVERTERS

2.4 Vdc - 5.5 Vdc Input, 0.6 Vdc - 3.63 Vdc /20 A Output



December 2, 2010

Bel Power Inc., a subsidiary of Bel Fuse Inc.

Output Specifications

Parameter	Min	Typ	Max	Unit	Notes	
Output Voltage Set Point	-1.5	-	+1.5	%Vo,set	with 0.5% tolerance for external resistor used to set output voltage	
Output Voltage	-3.0	-	+3.0	%Vo,set	Over all operating input voltage, resistive load, and temperature conditions until end of life	
Adjustment Range	0.6	-	3.63	V	selected by an external resistor	
Remote Sense Range	-	-	0.5	V		
Output Regulation (for $V_O \geq 2.5Vdc$)	-	-	0.4	%Vo,set	Line Regulation, $V_{IN}=V_{IN, min}$ to $V_{IN, max}$	
	-	-	0.4	%Vo,set	Load Regulation, $I_O=I_{O, min}$ to $I_{O, max}$	
Output Regulation (for $V_O < 2.5Vdc$)	-	-	10	mV	Line Regulation, $V_{IN}=V_{IN, min}$ to $V_{IN, max}$	
	-	-	10	mV	Load Regulation, $I_O=I_{O, min}$ to $I_{O, max}$	
	-	-	0.4	%Vo,set	Temperature Regulation, $T_{ref}=T_{A, min}$ to $T_{A, max}$	
Ripple and Noise (pk-pk)	-	20	35	mV	5Hz to 20MHz BW, $V_{IN}=V_{IN, nom}$ and $I_O=I_{O, min}$ to $I_{O, max}$, $C_o = 0.1\mu F // 10\mu F$ ceramic capacitors	
Ripple and Noise (rms)	-	10	15	mV		
Output Current Range	0	-	20	A		
Output DC Current Limit	-	200	-	%Io,max	Hiccup Mode	
Output Short-Circuit Current	-	30	-	%Io,max	$V_o \leq 250mV$, Hiccup Mode	
Output Capacitance	$ESR \geq 1 m\Omega$	0	-	200	μF	Without the Tunable Loop™
	$ESR \geq 0.15 m\Omega$	0	-	1000	μF	With the Tunable Loop™
	$ESR \geq 10 m\Omega$	0	-	10000	μF	With the Tunable Loop™
Turn-On Delay Time	-	2	-	mS	Case 1: On/Off input is enabled and then input power is applied (delay from instant at which $V_{IN} = V_{IN, min}$ until $V_o = 10\%$ of V_o, set)	
	-	2	-	mS	Case 2: Input power is applied for at least one second and then the On/Off input is enabled (delay from instant at which $V_{on/Off}$ is enabled until $V_o = 10\%$ of V_o, set)	
Output voltage Rise time	-	5	-	mS	time for V_o to rise from 10% of V_o, set to 90% of V_o, set	
Output voltage overshoot	-	-	3	%Vo	$V_{in}=V_{in, min}$ to $V_{in, max}$, $I_o=I_{o, max}$, With or without maximum external capacitance	
Dynamic Load Response						
$\Delta V_{0\% \sim 50\%}$ of Max Load	Peak Deviation	-	330	-	mV	$di/dt=10A/\mu s$, $V_{in}=3.3V$, $V_o=1.5V$, $T_a=25^\circ C$, $C_o=0$
	Settling Time	-	30	-	μS	
$\Delta V_{50\% \sim 0\%}$ of Max Load	Peak Deviation	-	420	-	mV	
	Settling Time	-	30	-	μS	

Note: Unless otherwise indicated, specifications apply over all operating input voltage, resistive load, and temperature conditions.

NON-ISOLATED DC/DC CONVERTERS

2.4 Vdc - 5.5 Vdc Input, 0.6 Vdc - 3.63 Vdc /20 A Output



December 2, 2010

Bel Power Inc., a subsidiary of Bel Fuse Inc.

General Specifications

Parameter	Min	Typ	Max	Unit	Notes	
Efficiency	Vo=0.6V	-	70.0	-	%	Vin= 3.3Vdc, Ta=25°C Io=Io, max , Vo= Vo,set Vin=5.0V, when Vo=3.3V
	Vo=1.2V	-	81.9	-	%	
	Vo=1.8V	-	87.3	-	%	
	Vo=2.5V	-	90.8	-	%	
	Vo=3.3V	-	92.9	-	%	
Switching Frequency	-	600	-	kHz		
Over Temperature Protection	-	144	-	°C		
Sequencing Delay time	10	-	-	mS	Delay from VIN, min to application of voltage on SEQ pin	
Tracking Accuracy	Power-Up: 2V/ms	-	-	100	mV	VIN, min to VIN, max; Io, min - Io, max VSEQ < Vo
	Power-Down: 2V/ms	-	-	100	mV	
Weight	-	6.03	-	g		
MTBF	7,868,128			hours	Calculated MTBF (Vin=5V, Io=80% full load, Ta=40°C) Telcordia Issue 2, Method I Case 3	
Dimensions	Inches (L x W x H)	1.30 x 0.53 x 0.334		-		
	Millimeters (L x W x H)	33.02 x 13.46 x 8.50				

Note: Unless otherwise indicated, specifications apply over all operating input voltage, resistive load, and temperature conditions.

NON-ISOLATED DC/DC CONVERTERS

2.4 Vdc - 5.5 Vdc Input, 0.6 Vdc - 3.63 Vdc /20 A Output



December 2, 2010

Bel Power Inc., a subsidiary of Bel Fuse Inc.

Efficiency Data

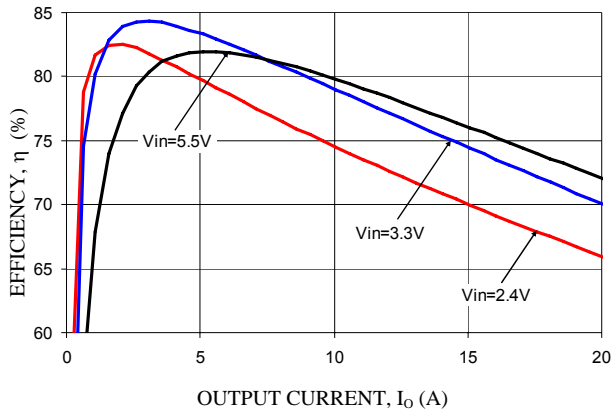

Vo=0.6V

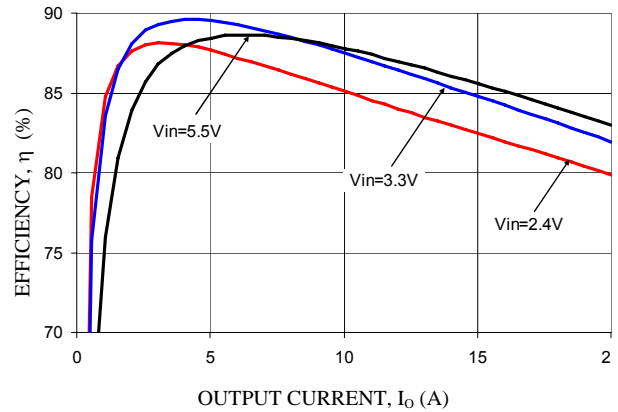

Vo=1.2V

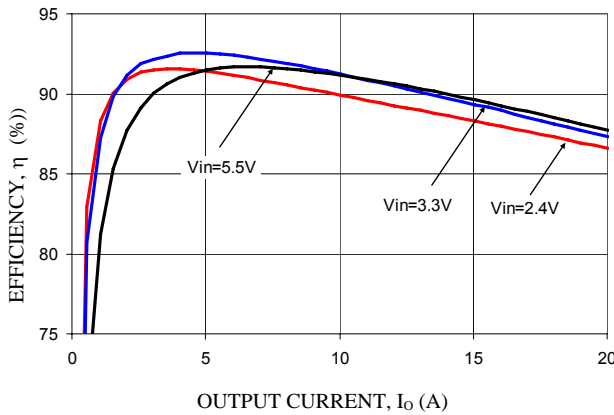

Vo=1.8V

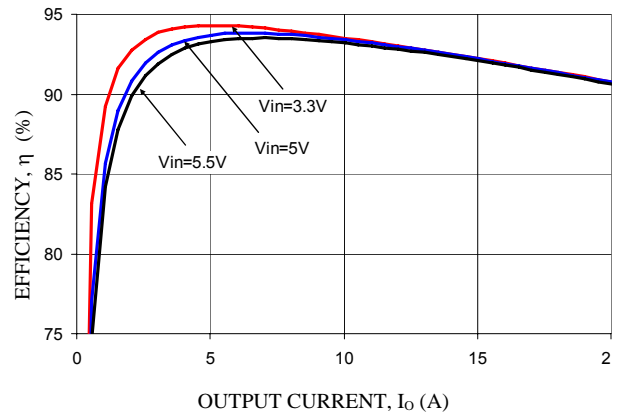

Vo=2.5V

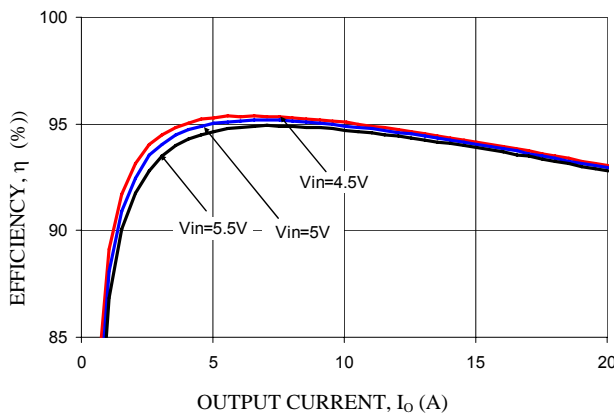

Vo=3.3V

NON-ISOLATED DC/DC CONVERTERS

2.4 Vdc - 5.5 Vdc Input, 0.6 Vdc - 3.63 Vdc /20 A Output



December 2, 2010

Bel Power Inc., a subsidiary of Bel Fuse Inc.

Thermal Derating Curves

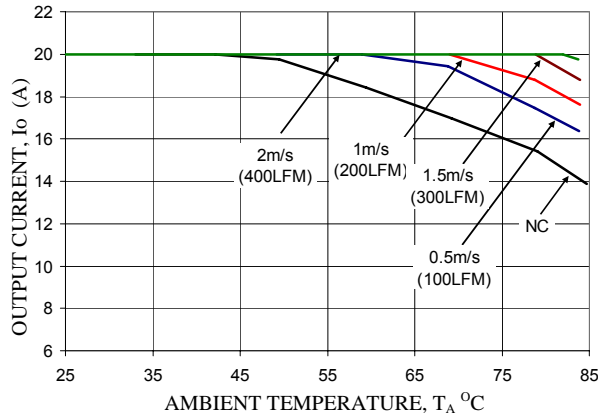

$V_o = 0.6V$

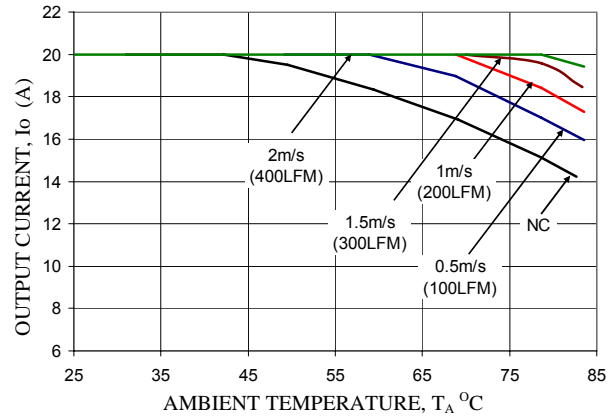

$V_o = 1.2V$

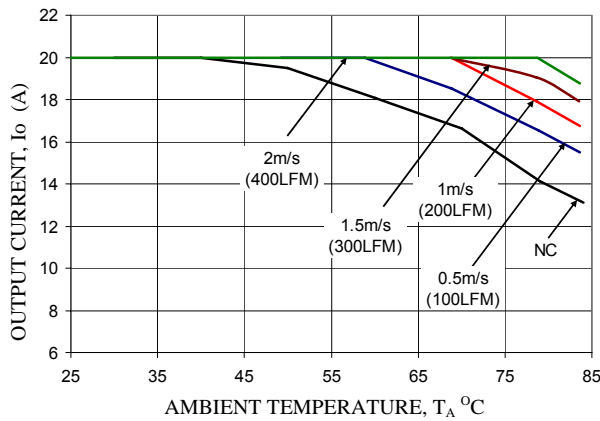

$V_o = 1.8V$

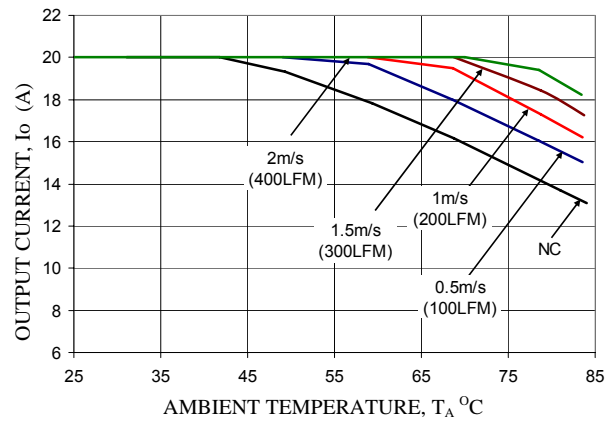

$V_o = 2.5V$

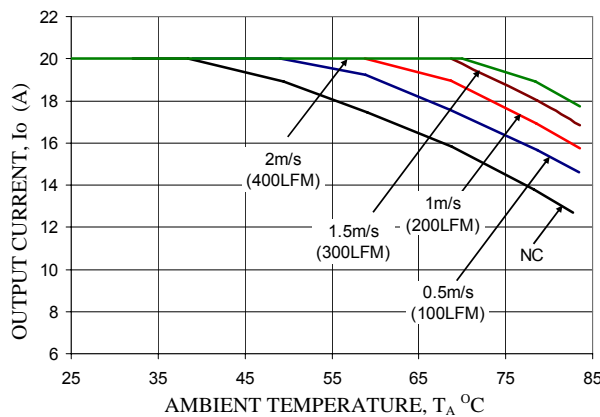

$V_o = 3.3V$

Ripple and Noise Waveforms

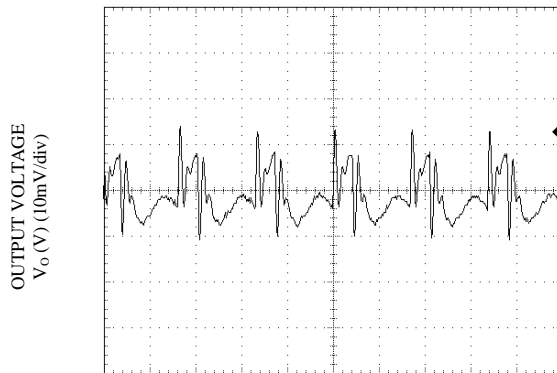

TIME, t (1µs/div)

Vin=3.3V, Vo=0.6V, Io = Io,max

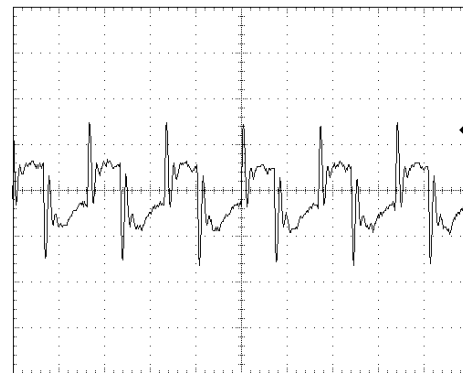

TIME, t (1µs/div)

Vin=3.3V, Vo=1.2V, Io = Io,max

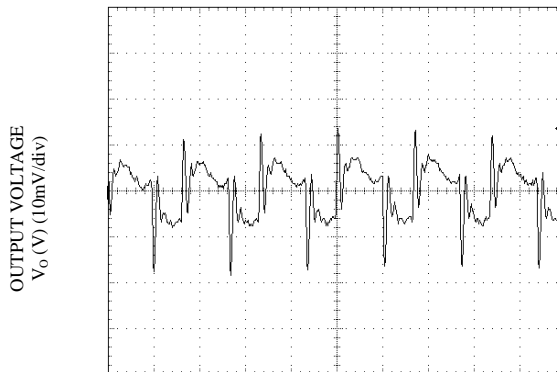

TIME, t (1µs/div)

Vin=3.3V, Vo=1.8V, Io = Io,max

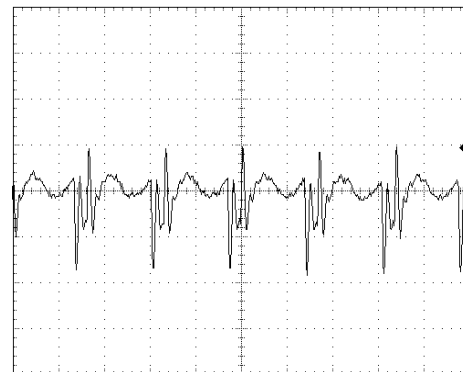

TIME, t (1µs/div)

Vin=3.3V, Vo=2.5V, Io = Io,max

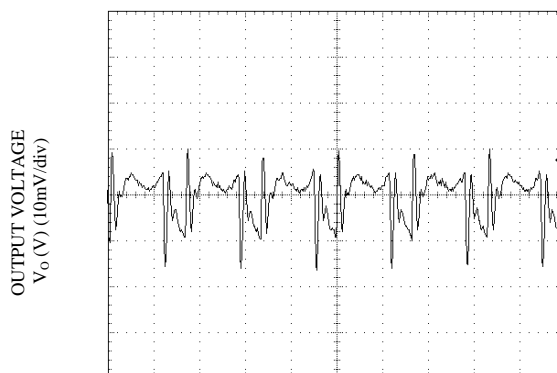

TIME, t (1µs/div)

Vin=5V, Vo=3.3V, Io = Io,max

Transient Response Waveforms

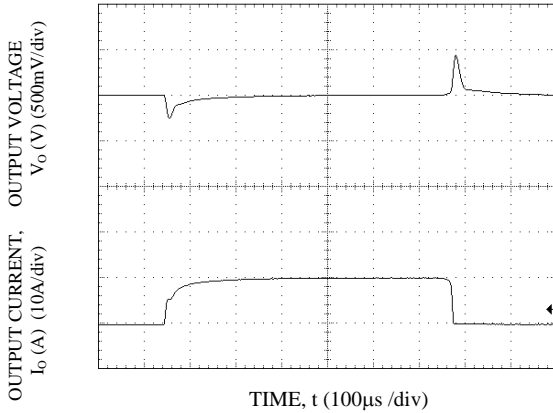

Transient Response to Dynamic Load Change from 0% 50% to 0%. Vin=3.3V, Vo=0.6V

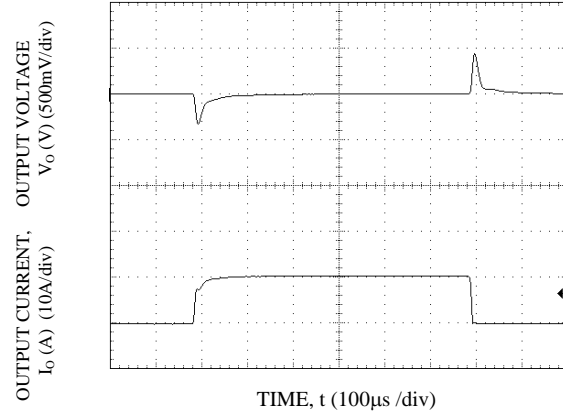

Transient Response to Dynamic Load Change from 0% 50% to 0%. Vin=3.3V, Vo=1.2V

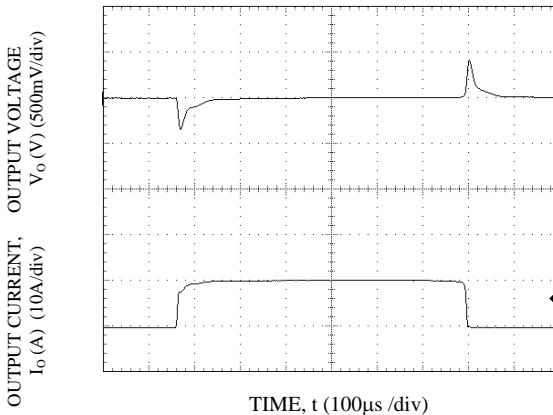

Transient Response to Dynamic Load Change from 0% 50% to 0%. Vin=3.3V, Vo=1.8V

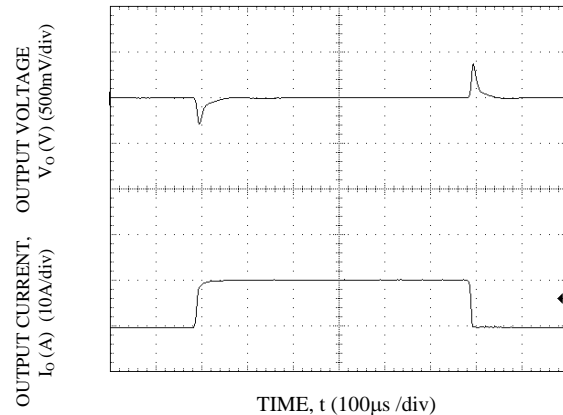

Transient Response to Dynamic Load Change from 0% 50% to 0%. Vin=5V, Vo=2.5V

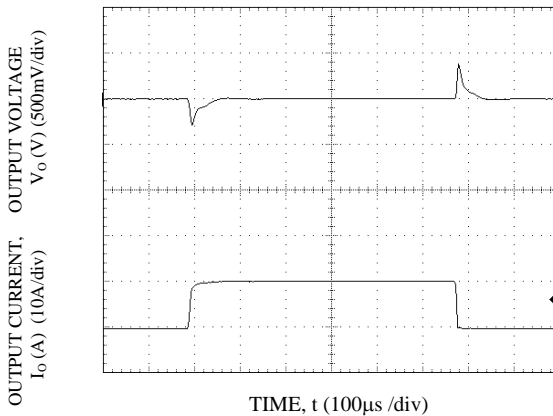

Transient Response to Dynamic Load Change from 0% 50% to 0%. Vin=5V, Vo=3.3V

Startup Time

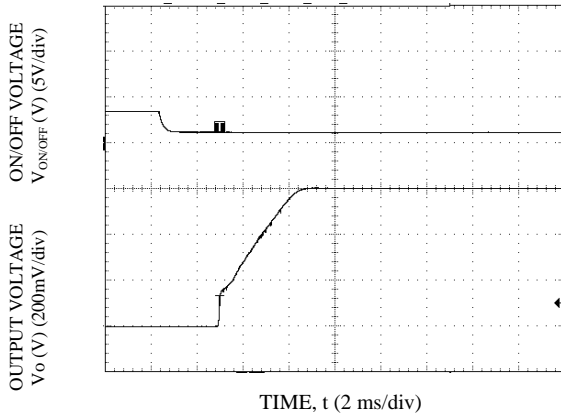

Start-up Using On/Off Voltage ($I_o = I_{o,max}$), $V_o=0.6V$

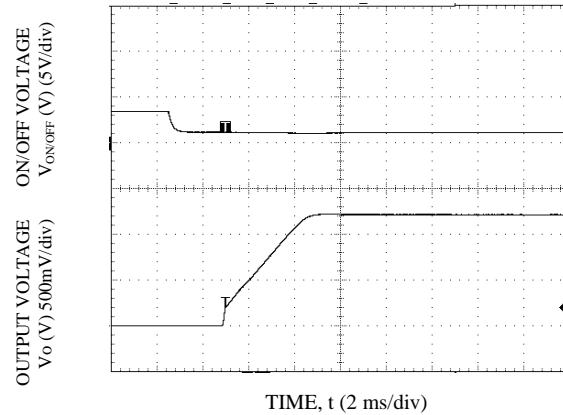

Start-up Using On/Off Voltage ($I_o = I_{o,max}$), $V_o=1.2V$

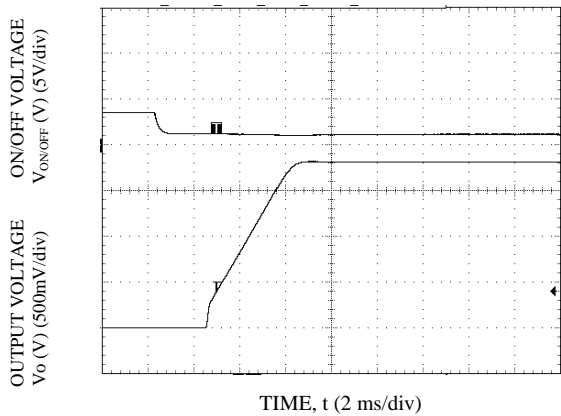

Start-up Using On/Off Voltage ($I_o = I_{o,max}$), $V_o=1.8V$

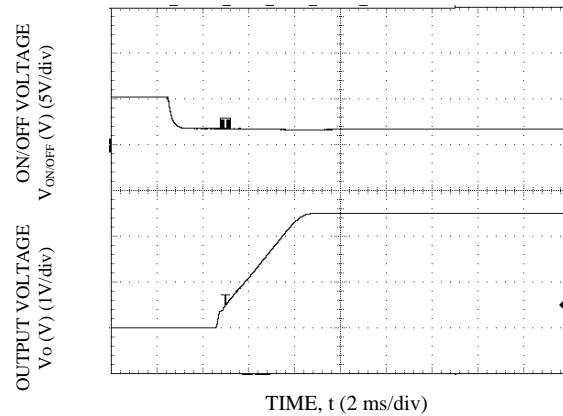

Start-up Using On/Off Voltage ($I_o = I_{o,max}$), $V_o=2.5V$

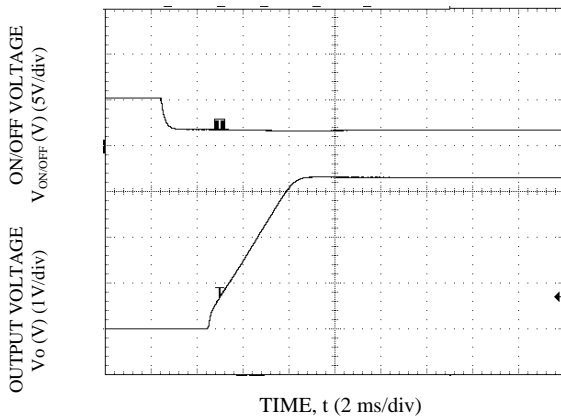

Start-up Using On/Off Voltage ($I_o = I_{o,max}$), $V_o=3.3V$

Startup Time (continued)

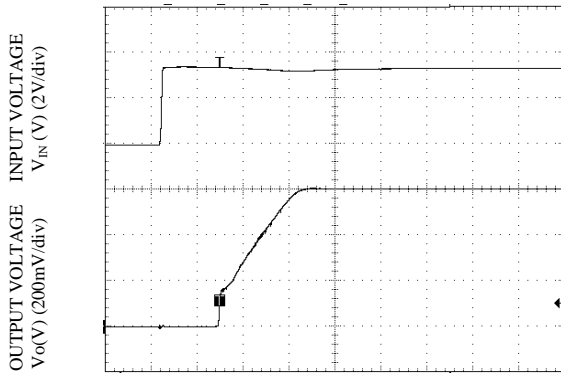

TIME, t (2 ms/div)

**Start-up Using Input Voltage ($V_{IN} = 3.3V$, $I_o = I_{o,max}$),
 $V_o=0.6V$**

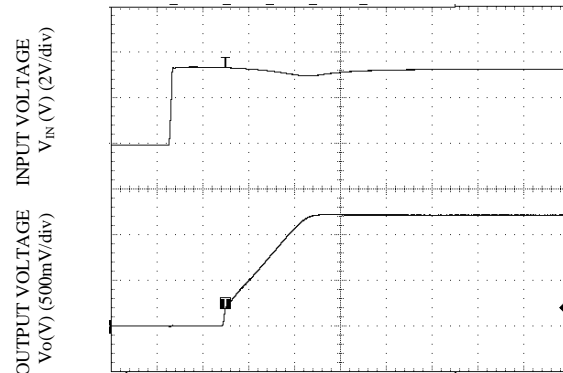

TIME, t (2 ms/div)

**Start-up Using Input Voltage ($V_{IN} = 3.3V$, $I_o = I_{o,max}$),
 $V_o=1.2V$**

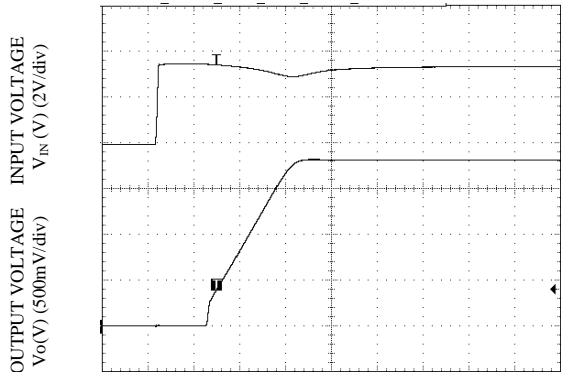

TIME, t (2 ms/div)

**Start-up Using Input Voltage ($V_{IN} = 3.3V$, $I_o = I_{o,max}$),
 $V_o=1.8V$**

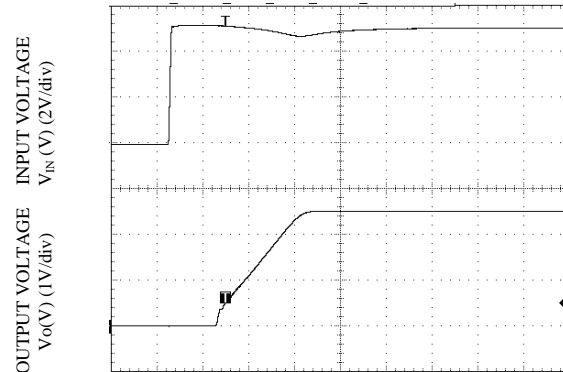

TIME, t (2 ms/div)

**Start-up Using Input Voltage ($V_{IN} = 5V$, $I_o = I_{o,max}$),
 $V_o=2.5V$**

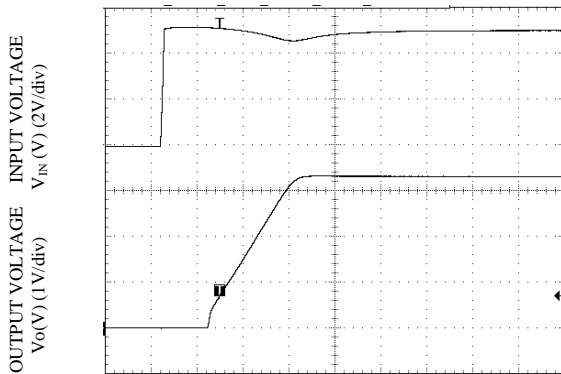

TIME, t (2 ms/div)

**Start-up Using Input Voltage ($V_{IN} = 5V$, $I_o = I_{o,max}$),
 $V_o=3.3V$**

NON-ISOLATED DC/DC CONVERTERS

2.4 Vdc - 5.5 Vdc Input, 0.6 Vdc - 3.63 Vdc /20 A Output



December 2, 2010

Bel Power Inc., a subsidiary of Bel Fuse Inc.

Test Configurations

Input Reflected Ripple Current Test Setup.

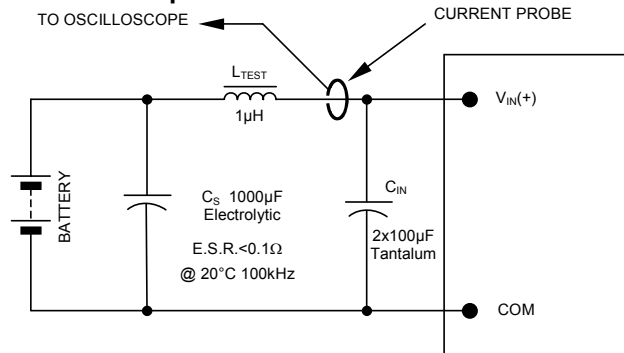

NOTE: Measure input reflected ripple current with a simulated source inductance (L_{TEST}) of $1\mu H$. Capacitor C_S offsets possible battery impedance. Measure current as shown above.

Output Ripple and Noise Test Setup.

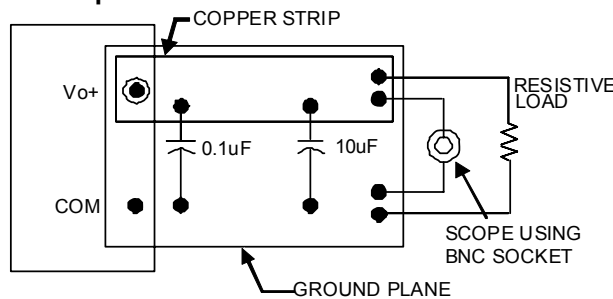

NOTE: All voltage measurements to be taken at the module terminals, as shown above. If sockets are used then Kelvin connections are required at the module terminals to avoid measurement errors due to socket contact resistance.

Output Voltage and Efficiency Test Setup.

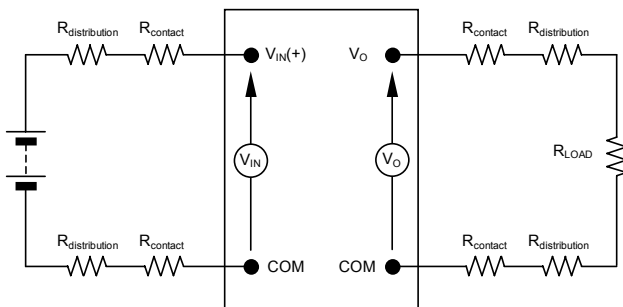

NOTE: All voltage measurements to be taken at the module terminals, as shown above. If sockets are used then Kelvin connections are required at the module terminals to avoid measurement errors due to socket contact resistance.

$$\text{Efficiency } \eta = \frac{V_O \cdot I_O}{V_{IN} \cdot I_{IN}} \times 100 \%$$

NON-ISOLATED DC/DC CONVERTERS

2.4 Vdc - 5.5 Vdc Input, 0.6 Vdc - 3.63 Vdc /20 A Output



December 2, 2010

Bel Power Inc., a subsidiary of Bel Fuse Inc.

Input Filtering

The SLIN-20F1Ax module should be connected to a low ac-impedance source. A highly inductive source can affect the stability of the module. An input capacitor must be placed directly adjacent to the input pin of the module, to minimize input ripple voltage and ensure module stability.

To minimize input voltage ripple, low-ESR ceramic capacitors are recommended at the input of the module. Figure A below shows the input ripple voltage for various output voltages at 20A of load current with 2x47 μ F or 4x47 μ F ceramic capacitors and an input of 5V. Figure B below shows data for the 3.3Vin case, with 2x47 μ F or 4x47 μ F of ceramic capacitors at the input.

Figure A

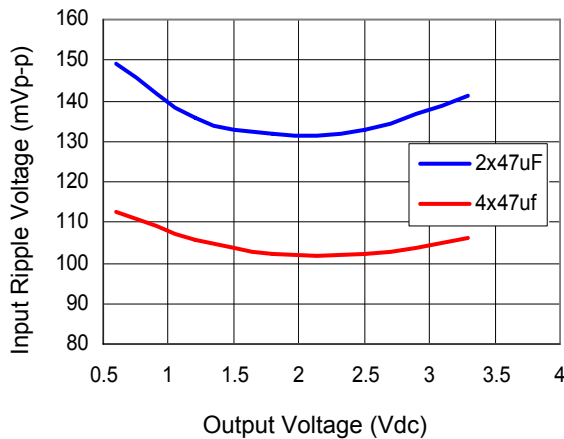
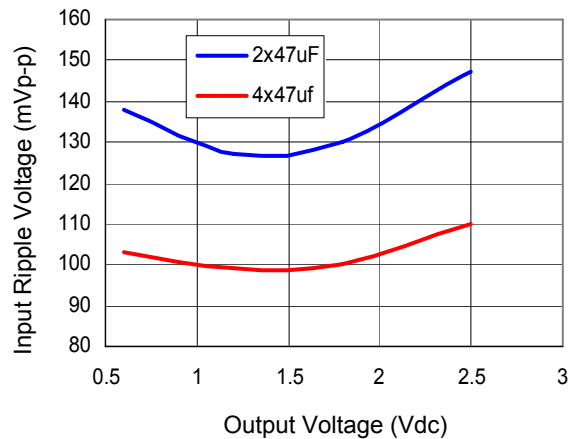

Figure B



Output Filtering

The SLIN-20F1Ax modules are designed for low output ripple voltage and will meet the maximum output ripple specification with 0.1 μ F ceramic and 10 μ F ceramic capacitors at the output of the module. However, additional output filtering may be required by the system designer for a number of reasons. First, there may be a need to further reduce the output ripple and noise of the module. Second, the dynamic response characteristics may need to be customized to a particular load step change.

To reduce the output ripple and improve the dynamic response to a step load change, additional capacitance at the output can be used. Low ESR ceramic and polymer capacitors are recommended to improve the dynamic response of the module. Figure A on the next page provides output ripple information for different external capacitance values at various V_o and for load currents of 20A while maintaining an input voltage of 5V. Figure B on the next page shows the performance with a 3.3V input. For stable operation of the module, limit the capacitance to less than the maximum output capacitance as specified in the electrical specification table. Optimal performance of the module can be achieved by using the Tunable Loop™ feature described later in this data sheet.

NON-ISOLATED DC/DC CONVERTERS

2.4 Vdc - 5.5 Vdc Input, 0.6 Vdc - 3.63 Vdc /20 A Output



December 2, 2010

Bel Power Inc., a subsidiary of Bel Fuse Inc.

Fig. A

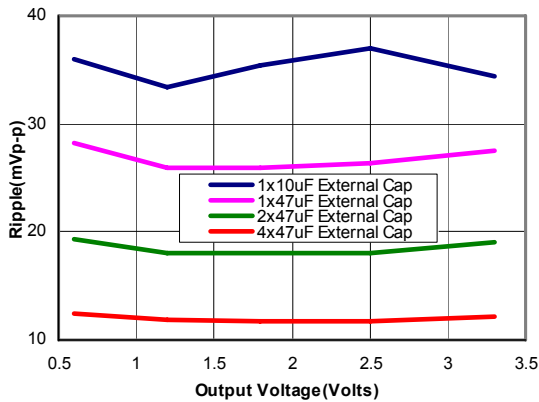
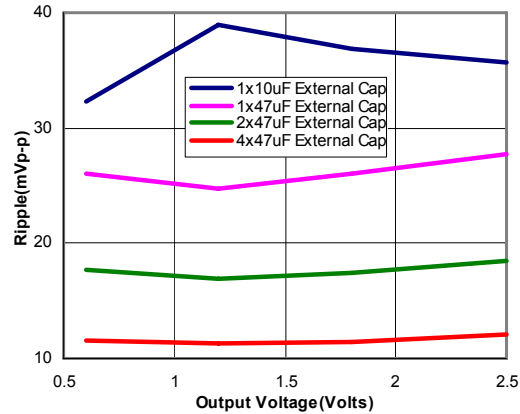

Fig. B



Safety Considerations

For safety agency approval the power module must be installed in compliance with the spacing and separation requirements of the end-use safety agency standards, i.e., UL 60950-1, CSA C22.2 No. 60950-1-03, and VDE 0850:2004-09 (EN60950-1) Licensed.

For the converter output to be considered meeting the requirements of safety extra-low voltage (SELV), the input must meet SELV requirements. The power module has extra-low voltage (ELV) outputs when all inputs are ELV.

The input to these units is to be provided with a fast-acting fuse with a maximum rating of 20A in the positive input lead.

Remote On/Off

Parameter	Min	Typ	Max	Unit	Notes
Signal Low (Unit On)	-0.2	-	Vin-1.6	V	The remote on/off pin open, Unit on.
Signal High (Unit Off)	Vin-0.8	-	Vin,max	V	
Signal Low (Unit Off)	-0.2	-	0.3	V	The remote on/off pin open, Unit on.
Signal High (Unit On)	Vin-0.8	-	Vin,max	V	

The SLIN-20F1Ax modules feature an On/Off pin for remote On/Off operation. Two On/Off logic options are available. In the Positive Logic On/Off option, the module turns ON during a logic High on the On/Off pin and turns OFF during a logic Low. With the Negative Logic On/Off option, the module turns OFF during logic High and ON during logic Low. The On/Off signal is always referenced to ground. For either On/Off logic option, leaving the On/Off pin disconnected will turn the module ON when input voltage is present.

For positive logic modules, the circuit configuration for using the On/Off pin is shown in Figure A on the next page. When the external transistor Q1 is in the OFF state, the On/Off pin is pulled high internally and the module is ON. When transistor Q1 is turned ON, the On/Off pin is pulled low and the module is OFF.

NON-ISOLATED DC/DC CONVERTERS

2.4 Vdc - 5.5 Vdc Input, 0.6 Vdc - 3.63 Vdc /20 A Output



December 2, 2010

Bel Power Inc., a subsidiary of Bel Fuse Inc.

Remote On/Off (cont.)

For negative logic On/Off modules, the circuit configuration is shown in Figure B on the next page. The On/Off pin should be pulled high with an external pull-up resistor (suggested value for the 2.4V to 5.5V_{in} range is 8.2Kohms). When transistor Q1 is in the OFF state, the On/Off pin is pulled high and the module is OFF. The

On/Off threshold for logic High on the On/Off pin depends on the input voltage and its minimum value is $V_{IN} - 1.6V$. To turn the module ON, Q1 is turned ON pulling the On/Off pin low.

Fig. A

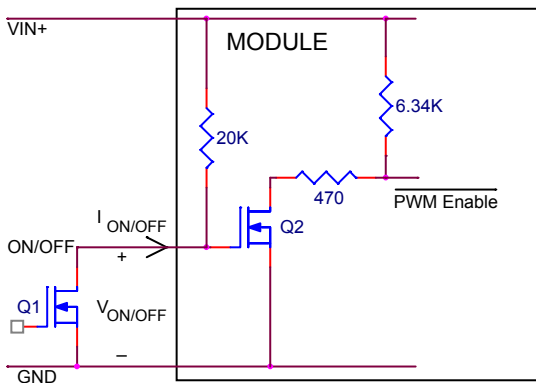
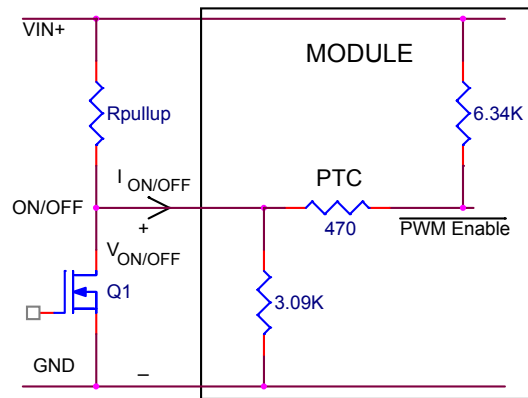

Fig. B



Over Current Protection

To provide protection in a fault (output overload) condition, the unit is equipped with internal current-limiting circuitry and can endure current limiting continuously. At the point of current-limit inception, the unit enters hiccup mode. The unit operates normally once the output current is brought back into its specified range.

Over Temperature Protection

To provide protection in a fault condition, the unit is equipped with a thermal shutdown circuit. The unit will shutdown if the over temperature threshold of 144°C is exceeded at the thermal reference point Tref. The thermal shutdown is not intended as a guarantee that the unit will survive temperatures beyond its rating. Once the unit goes into thermal shutdown it will then wait to cool before attempting to restart.

Input Under-voltage Lockout

At input voltages below the input under voltage lockout limit, the module operation is disabled. The module will begin to operate at an input voltage above the under voltage lockout turn-on threshold.

NON-ISOLATED DC/DC CONVERTERS

2.4 Vdc - 5.5 Vdc Input, 0.6 Vdc - 3.63 Vdc /20 A Output



December 2, 2010

Bel Power Inc., a subsidiary of Bel Fuse Inc.

Output Voltage Programming

The output voltage of the SLIN-20F1Ax module can be programmed to any voltage from 0.6dc to 3.63Vdc by connecting a resistor between the Trim and GND pins of the module. Certain restrictions apply on the output voltage set point depending on the input voltage. These are shown in the Output Voltage vs. Input Voltage Set Point Area plot in the figure below. The Upper Limit curve shows that the entire output voltage range is available with the maximum input voltage of 5.5V. The Lower Limit curve shows that for output voltages of 1.8V and higher, the input voltage needs to be larger than the minimum of 2.4V.

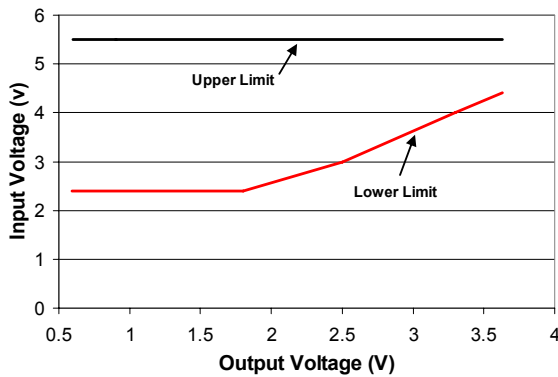

Without an external resistor between Trim and GND pins, the output of the module will be 0.6Vdc. To calculate the value of the trim resistor, R_{trim} for a desired output voltage, use the following equation:

$$R_{trim} = \left[\frac{1.2}{(V_o - 0.6)} \right] k\Omega$$

R_{trim} is the external resistor in $k\Omega$
 V_o is the desired output voltage

By using a $\pm 0.5\%$ tolerance trim resistor with a TC of $\pm 25\text{ppm}$, a set point tolerance of $\pm 1.5\%$ can be achieved as specified in the electrical specification. Table 1 provides R_{trim} values required for some common output voltages.

Table 1

$V_{O, set}$ (V)	R_{trim} (K Ω)
0.6	Open
1.0	3.0
1.2	2.0
1.5	1.333
1.8	1.0
2.5	0.632
3.3	0.444

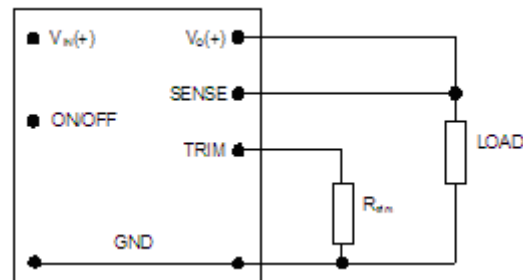

Circuit configuration for programming output voltage using an external resistor

NON-ISOLATED DC/DC CONVERTERS

2.4 Vdc - 5.5 Vdc Input, 0.6 Vdc - 3.63 Vdc /20 A Output



December 2, 2010

Bel Power Inc., a subsidiary of Bel Fuse Inc.

Remote Sense

The SLIN-20F1Ax power modules have a Remote Sense feature to minimize the effects of distribution losses by regulating the voltage at the SENSE pin. The voltage between the SENSE pin and VOUT pin must not exceed 0.5V. Note that the output voltage of the module cannot exceed the specified maximum value. This includes the voltage drop between the SENSE and Vout pins. When the Remote Sense feature is not being used, connect the SENSE pin to the VOUT pin.

Voltage Margining

Output voltage margining can be implemented in the SLIN-20F1Ax modules by connecting a resistor, $R_{\text{margin-up}}$, from the Trim pin to the ground pin for margining-up the output voltage and by connecting a resistor, $R_{\text{margin-down}}$, from the Trim pin to output pin for margining-down. The figure below shows the circuit configuration for output voltage margining.

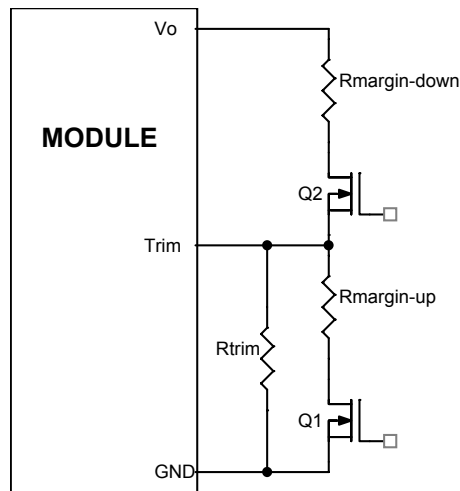

Circuit Configuration for margining Output voltage

Monotonic Start-up and Shutdown

The SLIN-20F1Ax modules have monotonic start-up and shutdown behavior for any combination of rated input voltage, output current and operating temperature range.

NON-ISOLATED DC/DC CONVERTERS

2.4 Vdc - 5.5 Vdc Input, 0.6 Vdc - 3.63 Vdc /20 A Output



December 2, 2010

Bel Power Inc., a subsidiary of Bel Fuse Inc.

Output Voltage Sequencing

The SLIN-20F1Ax modules include a sequencing feature that enables users to implement various types of output voltage sequencing in their applications. This is accomplished via an additional sequencing pin. When not using the sequencing feature, either tie the SEQ pin to V_{IN} or leave it unconnected.

When an analog voltage is applied to the SEQ pin, the output voltage tracks this voltage until the output reaches the set-point voltage. The final value of the SEQ voltage must be set higher than the set-point voltage of the module. The output voltage follows the voltage on the SEQ pin on a one-to-one basis. By connecting multiple modules together, multiple modules can track their output voltages to the voltage applied on the SEQ pin.

For proper voltage sequencing, first, input voltage is applied to the module. The On/Off pin of the module is left unconnected (or tied to GND for negative logic modules or tied to V_{IN} for positive logic modules) so that the module is ON by default. After applying input voltage to the module, a minimum 10msec delay is required before applying voltage on the SEQ pin. During this time, a voltage of 50mV (± 20 mV) must be maintained on the SEQ pin. This can be done by applying the sequencing voltage through a resistor R1 connected in series with the SEQ pin. By choosing R1 according to the following equation:

$$R1 = \frac{24950}{V_{IN} - 0.05} \text{ ohms}$$

the voltage at the sequencing pin will be 50mV when the sequencing signal is at zero.

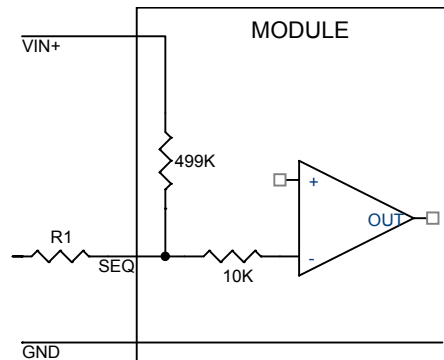

Circuit showing connection of the sequencing signal to the SEQ pin

After the 10msec delay, an analog voltage is applied to the SEQ pin and the output voltage of the module will track this voltage on a one-to-one volt basis until the output reaches the set-point voltage. To initiate simultaneous shutdown of the modules, the SEQ pin voltage is lowered in a controlled manner. The output voltage of the modules tracks the voltages below their set-point voltages on a one-to-one basis. A valid input voltage must be maintained until the tracking and output voltages reach ground potential.

When using the sequencing feature to control start-up of the module, pre-bias immunity during start-up is disabled. The pre-bias immunity feature of the module relies on the module being in the diode-mode during start-up. When using the sequencing feature, modules goes through an internal set-up time of 10msec, and will be in synchronous rectification mode when the voltage at the SEQ pin is applied. This will result in the module sinking current if a pre-bias voltage is present at the output of the module. When pre-bias immunity during start-up is required, the sequencing feature must be disabled. For additional guidelines on using the sequencing feature please contact the Bel Power technical representatives for additional information.

NON-ISOLATED DC/DC CONVERTERS

2.4 Vdc - 5.5 Vdc Input, 0.6 Vdc - 3.63 Vdc /20 A Output



December 2, 2010

Bel Power Inc., a subsidiary of Bel Fuse Inc.



Tunable Loop™

The SLIN-20F1Ax modules have a new feature that optimizes transient response of the module called Tunable Loop™.

External capacitors are usually added to the output of the module for two reasons: to reduce output ripple and noise and to reduce output voltage deviations from the steady-state value in the presence of dynamic load current changes. Adding external capacitance however affects the voltage control loop of the module, typically causing the loop to slow down with sluggish response. Larger values of external capacitance could also cause the module to become unstable.

The Tunable Loop™ allows the user to externally adjust the voltage control loop to match the filter network connected to the output of the module. The Tunable Loop™ is implemented by connecting a series R-C between the SENSE and TRIM pins of the module. This R-C allows the user to externally adjust the voltage loop feedback compensation of the module.

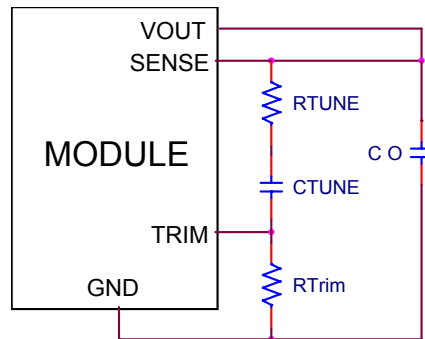

Circuit diagram showing connection of R_{TUNE} and C_{TUNE} to tune the control loop of the module

Recommended values of R_{TUNE} and C_{TUNE} for different output capacitor combinations are given in Tables 2, 3, 4 and 5. Tables 2 and 4 show the recommended values of R_{TUNE} and C_{TUNE} for different values of ceramic output capacitors up to 1000 μ F that might be needed for an application to meet output ripple and noise requirements for 5V_{in} and 3.3V_{in} respectively. Selecting R_{TUNE} and C_{TUNE} according to Tables 2 and 4 will ensure stable operation of the module.

In applications with tight output voltage limits in the presence of dynamic current loading, additional output capacitance will be required. Table 3 and 5 list recommended values of R_{TUNE} and C_{TUNE} in order to meet 2% output voltage deviation limits for some common output voltages in the presence of a 10A to 20A step change (50% of full load), with an input voltage of 5V_{in} and 3.3V_{in} respectively.

Table 2. General recommended values of R_{TUNE} and C_{TUNE} for $V_{in}=5V$ and various external ceramic capacitor combinations.

Co	1x47 μ F	2x47 μ F	4x47 μ F	10x47 μ F	20x47 μ F
R_{TUNE}	47	47	47	33	22
C_{TUNE}	3300pF	6800pF	12nF	33nF	56nF

NON-ISOLATED DC/DC CONVERTERS

2.4 Vdc - 5.5 Vdc Input, 0.6 Vdc - 3.63 Vdc /20 A Output



December 2, 2010

Bel Power Inc., a subsidiary of Bel Fuse Inc.

Table 3. Recommended values of R_{TUNE} and C_{TUNE} to obtain transient deviation of 2% of V_{out} for a 10A step load with $V_{in}=5V$.

V_o	3.3V	2.5V	1.8V	1.2V	0.6V
C_o	2x 330 μ F Polymer Cap	2x47 μ F + 2x330 μ F Polymer Cap	3x330 μ F Polymer Cap	4x47 μ F + 4x330 μ F Polymer Cap	10x330 μ F Polymer Cap
R_{TUNE}	47	39	39	33	27
C_{TUNE}	39nF	47nF	150nF	220nF	330nF
ΔV	64mV	49mV	36mV	24mV	12mV

Table 4. General recommended values of R_{TUNE} and C_{TUNE} for $V_{in}=3.3V$ and various external ceramic capacitor combinations.

C_{ext}	1x47 μ F	2x47 μ F	4x47 μ F	10x47 μ F	20x47 μ F
R_{TUNE}	47	47	33	33	22
C_{TUNE}	6800pF	12nF	22nF	47nF	68nF

Table 5. Recommended values of R_{TUNE} and C_{TUNE} to obtain transient deviation of 2% of V_{out} for a 10A step load with $V_{in}=3.3V$

V_o	2.5V	1.8V	1.2V	0.6V
C_o	5x330 μ F Polymer Cap	4x330 μ F Polymer Cap	5x330 μ F Polymer Cap	11x330 μ F Polymer Cap
R_{TUNE}	27	27	27	22
C_{TUNE}	470nF	470nF	470nF	470nF
ΔV	48mV	36mV	24mV	12mV

NON-ISOLATED DC/DC CONVERTERS

2.4 Vdc - 5.5 Vdc Input, 0.6 Vdc - 3.63 Vdc /20 A Output



December 2, 2010

Bel Power Inc., a subsidiary of Bel Fuse Inc.

Thermal Considerations

Power modules operate in a variety of thermal environments; however, sufficient cooling should always be provided to help ensure reliable operation.

Considerations include ambient temperature, airflow, module power dissipation, and the need for increased reliability. A reduction in the operating temperature of the module will result in an increase in reliability. The thermal data presented here is based on physical measurements taken in a wind tunnel. The test set-up is shown below.

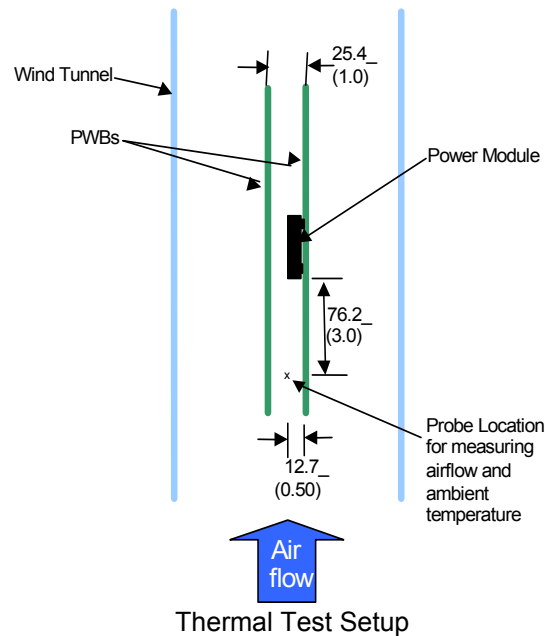

The thermal reference point, T_{ref} , used in the specifications is shown below. For reliable operation the temperatures at this point should not exceed 125°C. The output power of the module should not exceed the rated power of the module ($V_{o,set} \times I_{o,max}$).

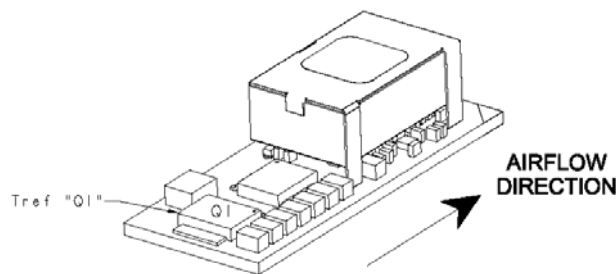

NON-ISOLATED DC/DC CONVERTERS

2.4 Vdc - 5.5 Vdc Input, 0.6 Vdc - 3.63 Vdc /20 A Output



December 2, 2010

Bel Power Inc., a subsidiary of Bel Fuse Inc.

Example Application Circuit

Requirements:

Vin: 3.3V
Vout: 1.8V
Iout: 15A max., worst case load transient is from 10A to 15A
 ΔV_{out} : 1.5% of Vout (27mV) for worst case load transient
Vin, ripple: 1.5% of Vin (50mV, p-p)

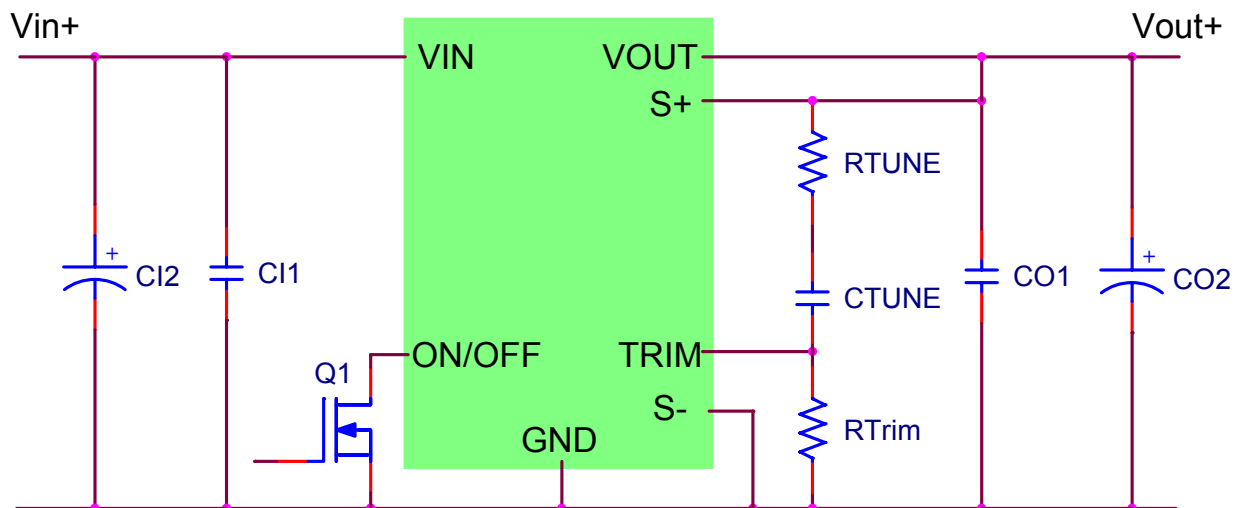

C11	200uF/16V bulk electrolytic
C12	5 x 47uF/6.3V ceramic capacitor (e.g. Murata GRM32ER60J476ME20)
CO1	6 x 47uF/6.3V ceramic capacitor (e.g. Murata GRM32ER60J476ME20)
CO2	2 x 470uF/2.5V Low ESR Polymer/poscap (e.g. Sanyo Poscap 2R5TPL470M7)
CTune	330nF/50V ceramic capacitor (can be 1206, 0805 or 0603 size)
RTune	27 ohms SMT resistor (can be 1206, 0805 or 0603 size)
RTrim	1k Ω SMT resistor (can be 1206, 0805 or 0603 size, recommended tolerance of 0.1%)

NON-ISOLATED DC/DC CONVERTERS
 2.4 Vdc - 5.5 Vdc Input, 0.6 Vdc - 3.63 Vdc /20 A Output



December 2, 2010

Bel Power Inc., a subsidiary of Bel Fuse Inc.

Mechanical Outline

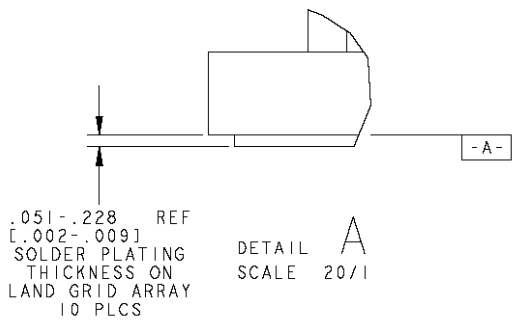
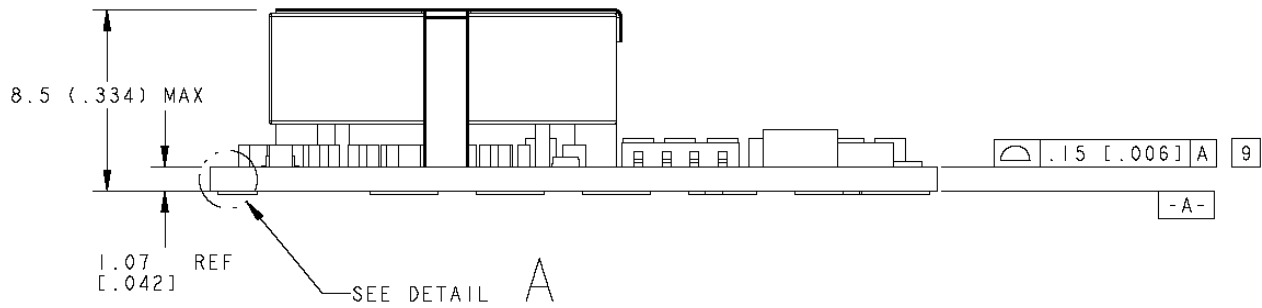
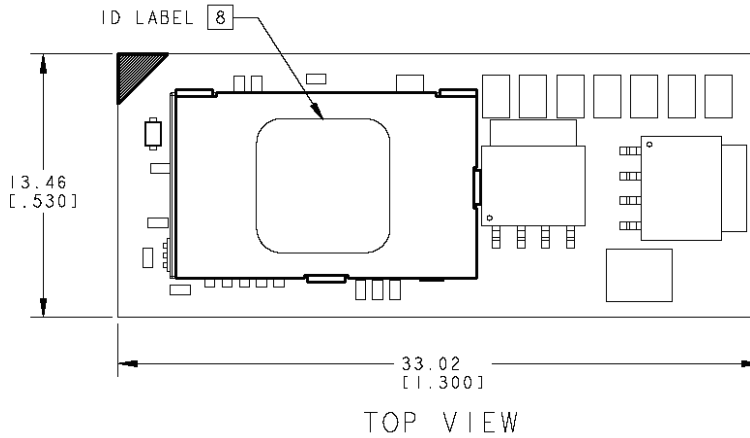

PIN	FUNCTION
1	ON/OFF
2	VIN
3	SEQ
4	GND
5	VOUT
6	TRIM
7	S+
8	S-
9	NC
10	NC

NON-ISOLATED DC/DC CONVERTERS

2.4 Vdc - 5.5 Vdc Input, 0.6 Vdc - 3.63 Vdc /20 A Output



December 2, 2010

Bel Power Inc., a subsidiary of Bel Fuse Inc.

Mechanical Outline (continued)

Recommended Pad Layout

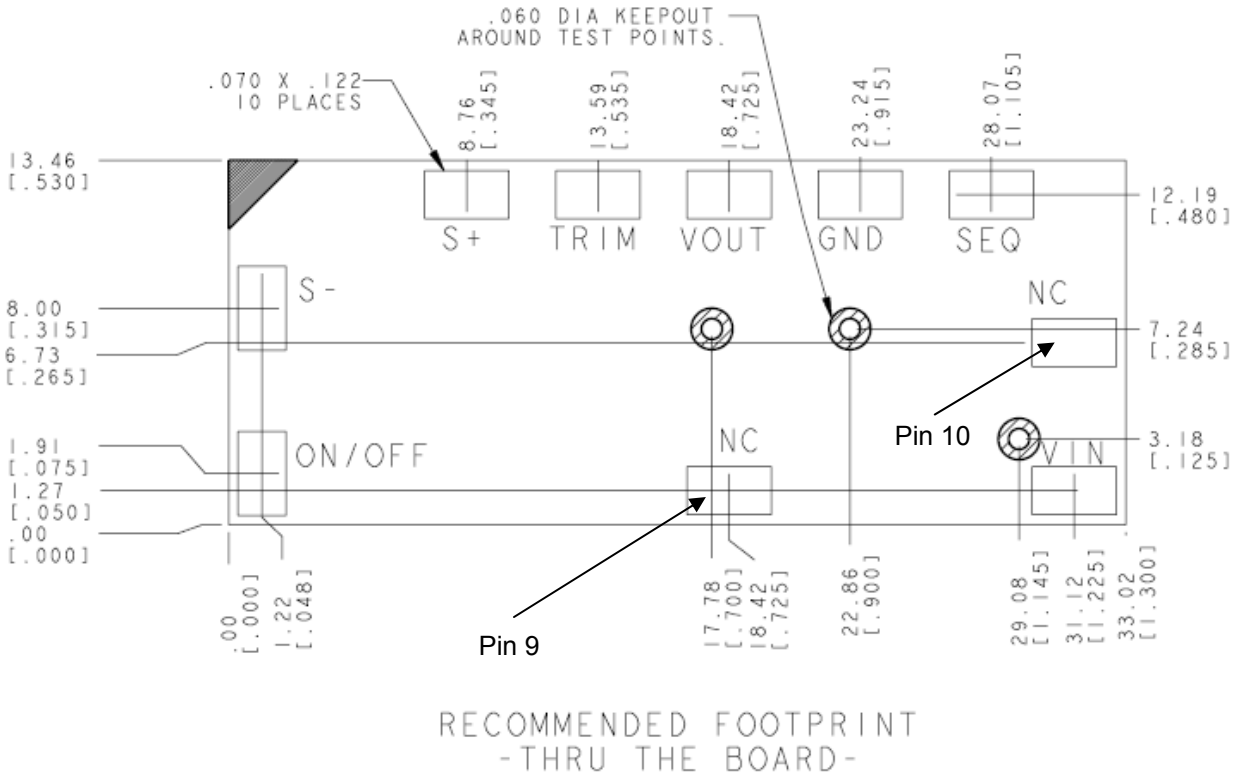

Dimensions are in millimeters and (inches).

Tolerances: $x.x \text{ mm} \pm 0.5 \text{ mm}$ ($x.xx \text{ in.} \pm 0.02 \text{ in.}$) [unless otherwise indicated]

$x.xx \text{ mm} \pm 0.25 \text{ mm}$ ($x.xxx \text{ in.} \pm 0.010 \text{ in.}$)

NON-ISOLATED DC/DC CONVERTERS

2.4 Vdc - 5.5 Vdc Input, 0.6 Vdc - 3.63 Vdc /20 A Output



December 2, 2010
Packaging Details

Bel Power Inc., a subsidiary of Bel Fuse Inc.

The SLIN-20F1Ax modules are supplied in tape & reel as standard.

All Dimensions are in millimeters and (in inches).

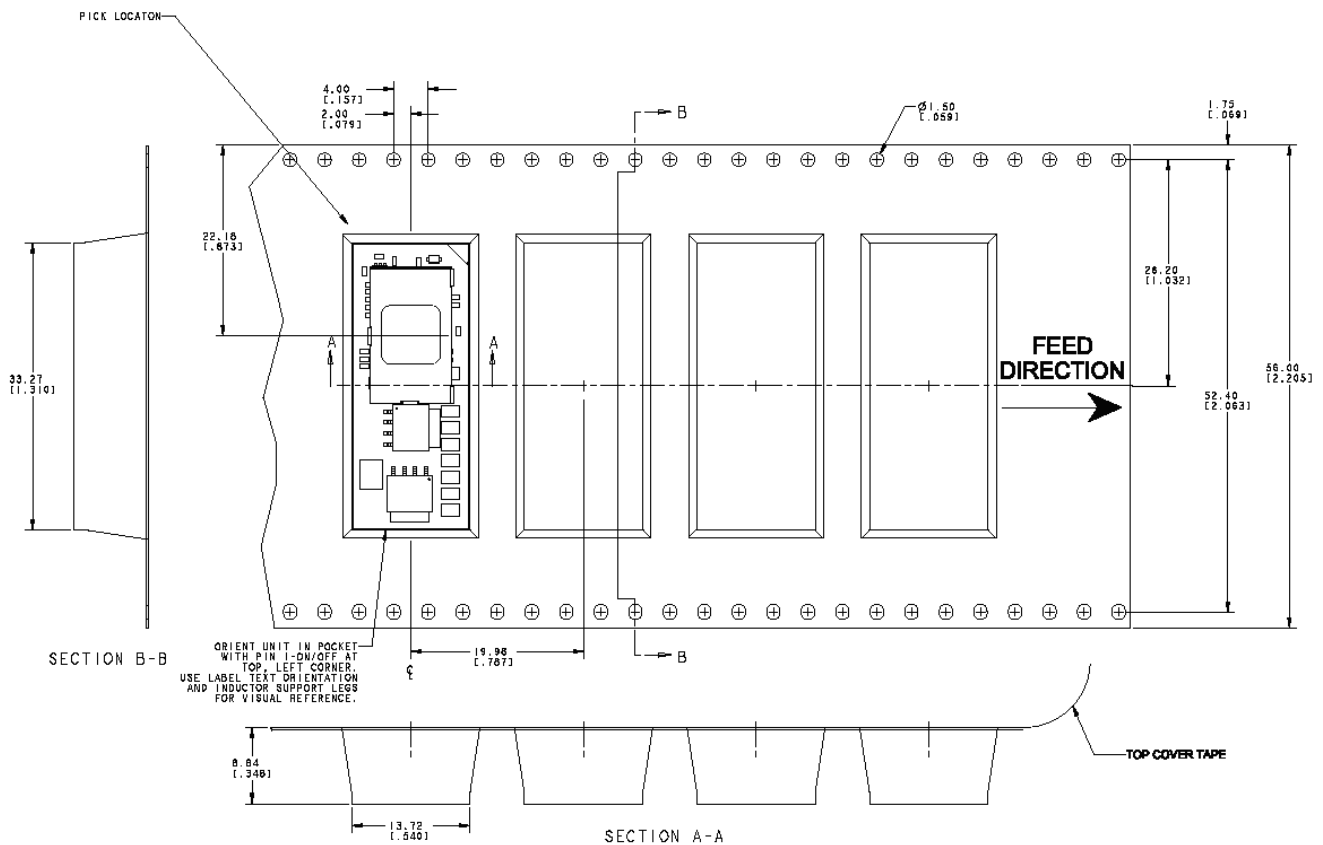
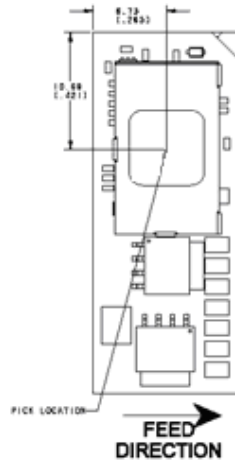

- Reel Dimensions:
- Outside Dimensions: 330.2 mm (13.00")
- Inside Dimensions: 177.8 mm (7.00")
- Tape Width: 44.00 mm (1.73")

NON-ISOLATED DC/DC CONVERTERS

2.4 Vdc - 5.5 Vdc Input, 0.6 Vdc - 3.63 Vdc /20 A Output



December 2, 2010

Bel Power Inc., a subsidiary of Bel Fuse Inc.

Surface Mount Information

Pick and Place

The SLIN-20F1Ax modules use an open frame construction and are designed for a fully automated assembly process. The modules are fitted with a label designed to provide a large surface area for pick and place operations. The label meets all the requirements for surface mount processing, as well as safety standards, and is able to withstand reflow temperatures of up to 300°C.

Nozzle Recommendations

The module weight has been kept to a minimum by using open frame construction. Variables such as nozzle size, tip style, vacuum pressure and placement speed should be considered to optimize this process. The minimum recommended inside nozzle diameter for reliable operation is 3mm. The maximum nozzle outer diameter, which will safely fit within the allowable component spacing, is 7 mm.

Lead Free Soldering

The SLIN-20F1Ax modules are lead-free (Pb-free) and RoHS compliant and are both forward and backward compatible in a Pb-free and a SnPb soldering process. Failure to observe the instructions may result in the failure of or cause damage to the modules and can adversely affect long-term reliability.

Pb-free Reflow Profile

Power Systems will comply with J-STD-020 Rev. C (Moisture/Reflow Sensitivity Classification for Nonhermetic Solid State Surface Mount Devices) for both Pb-free solder profiles and MSL classification procedures. This standard provides a recommended forced-air-convection reflow profile based on the volume and thickness of the package. The suggested Pb-free solder paste is Sn/Ag/Cu (SAC). The recommended linear reflow profile using Sn/Ag/Cu solder is shown below.

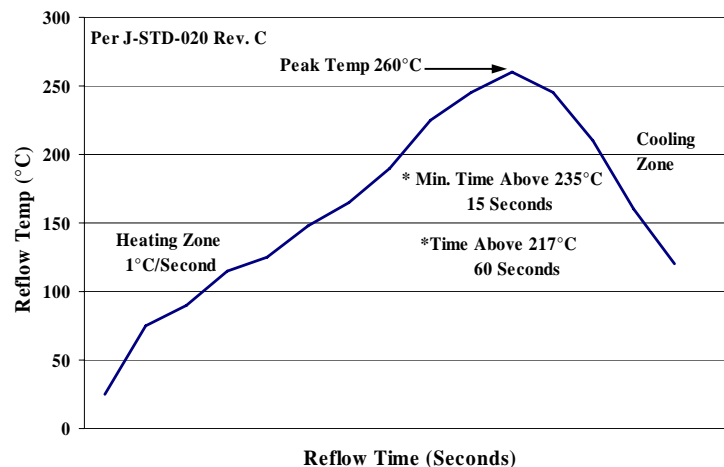

Recommended linear reflow profile using Sn/Ag/Cu solder

MSL Rating

The SLIN-20F1Ax modules have a MSL rating of 2.

NON-ISOLATED DC/DC CONVERTERS

2.4 Vdc - 5.5 Vdc Input, 0.6 Vdc - 3.63 Vdc /20 A Output



December 2, 2010

Bel Power Inc., a subsidiary of Bel Fuse Inc.

Storage and Handling

The recommended storage environment and handling procedures for moisture-sensitive surface mount packages is detailed in J-STD-033 Rev. A (Handling, Packing, Shipping and Use of Moisture/Reflow Sensitive Surface Mount Devices). Moisture barrier bags (MBB) with desiccant are required for MSL ratings of 2 or greater. These sealed packages should not be broken until time of use. Once the original package is broken, the floor life of the product at conditions of $\leq 30^{\circ}\text{C}$ and 60% relative humidity varies according to the MSL rating (see J-STD-033A). The shelf life for dry packed SMT packages will be a minimum of 12 months from the bag seal date, when stored at the following conditions: $< 40^{\circ}\text{C}$, $< 90\%$ relative humidity.

Post Solder Cleaning and Drying Considerations

Post solder cleaning is usually the final circuit-board assembly process prior to electrical board testing. The result of inadequate cleaning and drying can affect both the reliability of a power module and the testability of the finished circuit-board assembly.

Revision History

Date	Revision	Changes Detail	Approval
2010-4-14	A	First release	T. Bubriski
2010-12-2	B	Updated the Example Application Circuit on page 21.	T. Bubriski

RoHS Compliance

Complies with the European Directive 2002/95/EC, calling for the elimination of lead and other hazardous substances from electronic products.



©2010 Bel Fuse Inc. Specifications subject to change without notice. 120210

26

CORPORATE

Bel Fuse Inc.
206 Van Vorst Street
Jersey City, NJ 07302
Tel 201-432-0463
Fax 201-432-9542
www.belfuse.com

FAR EAST

Bel Fuse Ltd.
8F/ 8 Luk Hop Street
San Po Kong
Kowloon, Hong Kong
Tel 852-2328-5515
Fax 852-2352-3706
www.belfuse.com

EUROPE

Bel Fuse Europe Ltd.
Preston Technology Management Centre
Marsh Lane, Suite G7, Preston
Lancashire, PR1 8UD, U.K.
Tel 44-1772-556601
Fax 44-1772-888366
www.belfuse.com