



STL-1204-W02ME90

**SICK**  
Sensor Intelligence.



## Ordering information

Type	Part no.
STL-1204-W02ME90	6047912

Other models and accessories → [www.sick.com/](http://www.sick.com/)

## Detailed technical data

### Technical specifications

<b>Accessory group</b>	Plug connectors and cables
<b>Accessory family</b>	Connecting cables
<b>Connection type head A</b>	Male connector, M12, 4-pin, angled, D-coded
<b>Connection type head B</b>	Flying leads
<b>Locking nut material</b>	Zinc die-cast, nickel-plated
<b>Cable</b>	2 m, 4-wire, CAT5, CAT5e, PUR, halogen-free
<b>Jacket material</b>	PUR, halogen-free
<b>Jacket color</b>	Water blue (RAL 5021)
<b>Cable diameter</b>	6.4 mm
<b>Conductor cross-section</b>	2 x 2 x 0.14 mm <sup>2</sup>
<b>Shielding</b>	Shielded
<b>Bending radius</b>	
Flexible use	> 8 x cable diameter
Stationary position	> 4 x cable diameter
<b>Signal type</b>	Ethernet
<b>Transmission characteristics</b>	CAT5
<b>Data transmission rate</b>	≤ 100 Mbit/s
<b>Enclosure rating</b>	IP65/ IP67
<b>Description</b>	M12 male connector D-coded angled to open end
<b>Ambient operating temperature</b>	
Stationary position	-20 °C ... +80 °C

### Classifications

<b>ECl@ss 5.0</b>	19030312
<b>ECl@ss 5.1.4</b>	19030312
<b>ECl@ss 6.0</b>	27060304
<b>ECl@ss 6.2</b>	27060304
<b>ECl@ss 7.0</b>	27060304
<b>ECl@ss 8.0</b>	27060304
<b>ECl@ss 8.1</b>	27060304
<b>ECl@ss 9.0</b>	27060304
<b>ETIM 5.0</b>	EC000830

<b>ETIM 6.0</b>	EC000830
<b>UNSPSC 16.0901</b>	26121604

Dimensional drawing (Dimensions in mm (inch))

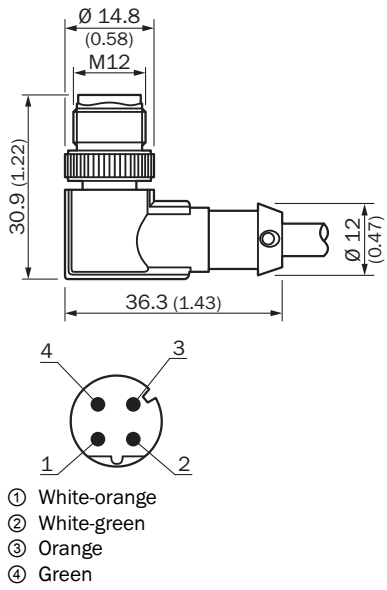

## SICK AT A GLANCE

SICK is one of the leading manufacturers of intelligent sensors and sensor solutions for industrial applications. A unique range of products and services creates the perfect basis for controlling processes securely and efficiently, protecting individuals from accidents and preventing damage to the environment.

We have extensive experience in a wide range of industries and understand their processes and requirements. With intelligent sensors, we can deliver exactly what our customers need. In application centers in Europe, Asia and North America, system solutions are tested and optimized in accordance with customer specifications. All this makes us a reliable supplier and development partner.

Comprehensive services complete our offering: SICK LifeTime Services provide support throughout the machine life cycle and ensure safety and productivity.

For us, that is “Sensor Intelligence.”

## WORLDWIDE PRESENCE:

Contacts and other locations –[www.sick.com](http://www.sick.com)