

Circuit Breaker for Equipment, thermal, Threaded-neck type, 1?pole



Approvals and Compliances

Weblinks

[pdf datasheet](#), [html-datasheet](#), [General Product Information](#), [Distributor-Stock-Check](#), [Detailed request for product](#), [Product News](#)



Approvals and Compliances

Detailed information on product approvals, code requirements, usage instructions and detailed test conditions can be looked up in [Details about Approvals](#)

Detailed information on product approvals, code requirements, usage instructions and detailed test conditions can be looked up in [Details about Approvals](#)

Compliances

The product complies with following Guide Lines

Identification	Details	Initiator	Description
	RoHS	SCHURTER AG	EU Directive RoHS 2011/65/EU
	REACH	SCHURTER AG	On 1 June 2007, Regulation (EC) No 1907/2006 on the Registration, Evaluation, Authorization and Restriction of Chemicals 1 (abbreviated as "REACH") entered into force.

CIRCUIT BREAKERS FOR EQUIPMENT

TS-LINE

Product description

The TS-line consists of a series of low cost thermally operated CBEs available in three frame sizes for rated currents up to 40 A.

They are intended to provide protection against sustained overloads. All CBEs of the TS-line use a thermo-bimetal to simulate the thermal behavior of the protected components, which could be conductors in wiring, motors, transformers etc.

The snap-action type of bimetal opens the contact when the temperature of the bimetal has reached a certain threshold level. The circuit will then remain open unless the reset (or ON-) button is permanently depressed. In this case the snap-action contact will momentarily re-close until the bimetal has reached its trip-temperature again and effects the automatic opening operation. This behavior is termed «cycling trip-free». The «cycling» indicates the momentary re-closings which do occur, the «trip-free» indicates that the opening operation of the contacts can not be prevented by pressing the ON or the RESET button.

Every CBE of the TS-line can well cope with overload currents up to 6 times the rated currents without any back-up assistance. If the fault current could be higher, CBEs require back-up protection. In many instances, this back-up protection is provided by the protective devices of the building installation.

The TS-Line is designed for automatic interruption and non-automatic (manual) resetting only (R-type CBEs). They utilize a reliable snap-action bimetal to achieve the automatic opening operation and quick connect terminals for easy connection.

Common features are:

- Attractive prices
- Wide range of ratings
- Reliable design
- Approvals

The TS-701 line has a threaded neck for panel mounting. The overall dimensions are slightly bigger, but the available ratings are considerably higher (up to 40 A).

The TS-709 line is a push to reset type CBE for panel mounting (threaded neck). Its strong points are the small size and the attractive price. Rated current are from 3A to 16A.

The TS-710 line fits into the mounting cut-off of miniature fuseholders. Where the advantage of having a reusable protective device counts, this CBE has its application.



CIRCUIT BREAKERS FOR EQUIPMENT

TS-701

Effect of ambient temperature

The unit is calibrated for an ambient temperature of +25°C. To determine the rated current for a lower or higher ambient temperature, use a correction factor from the table below:

Ambient temperature [°C]	Correction factor	
	Rated current 3-5 A	6-40 A
+10	0,69	0,8
+15	0,74	0,87
+20	0,83	0,91
+25	1,0	1,0
+30	1,43	1,18
+35	1,82	1,25
+40	2,22	1,39
+45		1,54
+50		1,67
+55		1,82
+60		2,0

Example

Rated current at +25°C 10,0 A
 Ambient temperature +40°C
 Correction factor 1,39
 Chosen rated current at
 +40°C ambient temperature
10 A x 1,39 = 14 A

Tripping characteristic

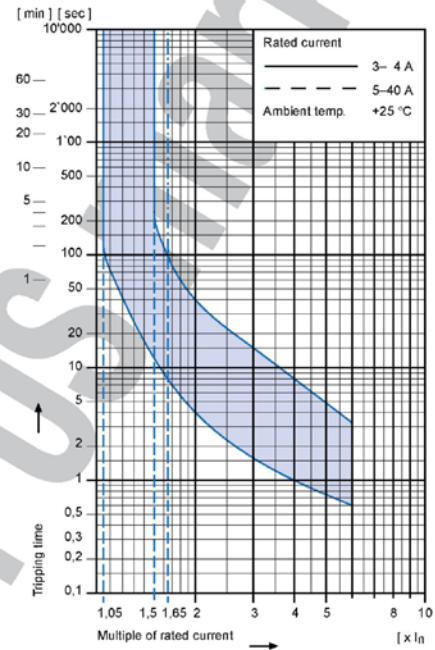

Technical data

Rated voltage Ue	See approvals, page 47E	AC 125; 250 V DC 50 V
Rated current I _n	See approvals, page 47E	3 – 40 A
Conditional short circuit current I _{nc}	PC1, AC 250 V	1000 A
Short circuit capacity I _{cn}	AC 240 V	200 A
Dielectric strength		AC 1500 V
Endurance	Number of cycles at 1,5 x I _n (AC 125 V)	500
Type of actuation	• Reset type	R
Type of tripping	• Thermal • Cycling trip-free	TO
Weight		approx. 24 g

CIRCUIT BREAKERS FOR EQUIPMENT

TS-701

Approvals

		Type TS-701-HT		Type TS-701-HC		
		Rated current range	Rated voltage AC	Rated current range	Rated voltage AC	
	UL	1077	3 – 30 A	250 V	3 – 30 A	250 V
	CSA	C 22,2	3 – 30 A	125 V	3 – 30 A	125 V

Order code



Basic type
 TS-701 Single pole thermal overload protection switch, cycling trip-free

Mounting style
 HT Threaded neck type 3/8" x 28T
 HC Snap-in type (Plastic double spring)

Standard configuration for HT + HC

Actuation type
 Reset type

Terminal type
 6,3 x 0,8 mm quick connect terminals

Rated current
 3 4 5 6 8 10 12 15 16 20 25 28 30
 35 40
 See approvals above

Accessories
 P Plastic knurled nut
 K Metal knurled nut
 H Metal hexagonal nut

T S - 7 0 1 - HT - 12 - P

Order example



CIRCUIT BREAKERS FOR EQUIPMENT

TS-701

Threaded neck type

Snap-in type

TS-701 HT

TS-701 HC

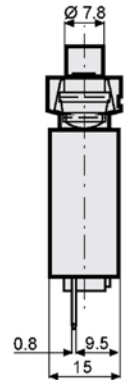
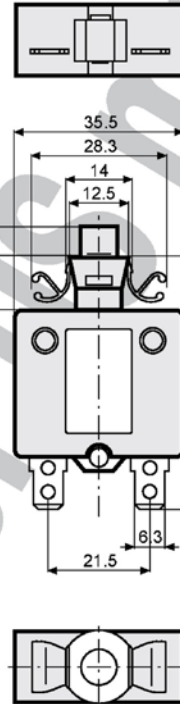
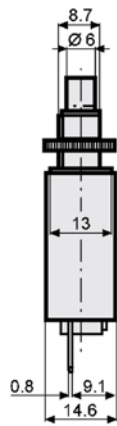
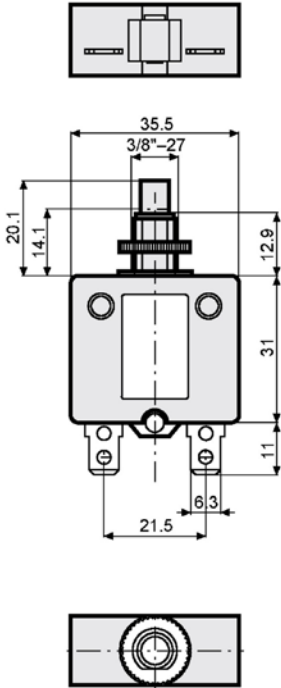

Cut-out

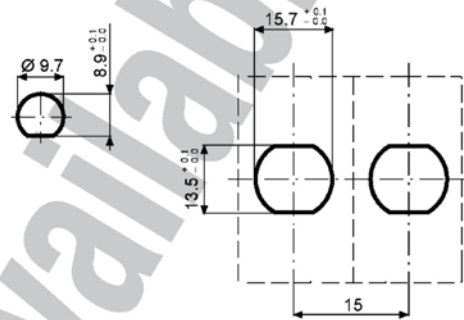

Schematic diagram – accessories

Schematic diagram



Accessories

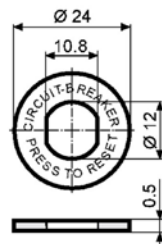

CIRCUIT BREAKERS FOR EQUIPMENT

TS-LINE

Product description

The TS-line consists of a series of low cost thermally operated CBEs available in three frame sizes for rated currents up to 40 A.

They are intended to provide protection against sustained overloads. All CBEs of the TS-line use a thermo-bimetal to simulate the thermal behavior of the protected components, which could be conductors in wiring, motors, transformers etc.

The snap-action type of bimetal opens the contact when the temperature of the bimetal has reached a certain threshold level. The circuit will then remain open unless the reset (or ON-) button is permanently depressed. In this case the snap-action contact will momentarily re-close until the bimetal has reached its trip-temperature again and effects the automatic opening operation. This behavior is termed «cycling trip-free». The «cycling» indicates the momentary re-closings which do occur, the «trip-free» indicates that the opening operation of the contacts can not be prevented by pressing the ON or the RESET button.

Every CBE of the TS-line can well cope with overload currents up to 6 times the rated currents without any back-up assistance. If the fault current could be higher, CBEs require back-up protection. In many instances, this back-up protection is provided by the protective devices of the building installation.

The TS-Line is designed for automatic interruption and non-automatic (manual) resetting only (R-type CBEs). They utilize a reliable snap-action bimetal to achieve the automatic opening operation and quick connect terminals for easy connection.

Common features are:

- Attractive prices
- Wide range of ratings
- Reliable design
- Approvals

The TS-701 line has a threaded neck for panel mounting. The overall dimensions are slightly bigger, but the available ratings are considerably higher (up to 40 A).

The TS-709 line is a push to reset type CBE for panel mounting (threaded neck). Its strong points are the small size and the attractive price. Rated current are from 3A to 16A.

The TS-710 line fits into the mounting cut-off of miniature fuseholders. Where the advantage of having a reusable protective device counts, this CBE has its application.



CIRCUIT BREAKERS FOR EQUIPMENT

TS-701

Effect of ambient temperature

The unit is calibrated for an ambient temperature of +25°C. To determine the rated current for a lower or higher ambient temperature, use a correction factor from the table below:

Ambient temperature [°C]	Correction factor	
	Rated current 3-5 A	6-40 A
+10	0,69	0,8
+15	0,74	0,87
+20	0,83	0,91
+25	1,0	1,0
+30	1,43	1,18
+35	1,82	1,25
+40	2,22	1,39
+45		1,54
+50		1,67
+55		1,82
+60		2,0

Example

Rated current at +25°C 10,0 A
 Ambient temperature +40°C
 Correction factor 1,39
 Chosen rated current at
 +40°C ambient temperature
10 A x 1,39 = 14 A

Tripping characteristic

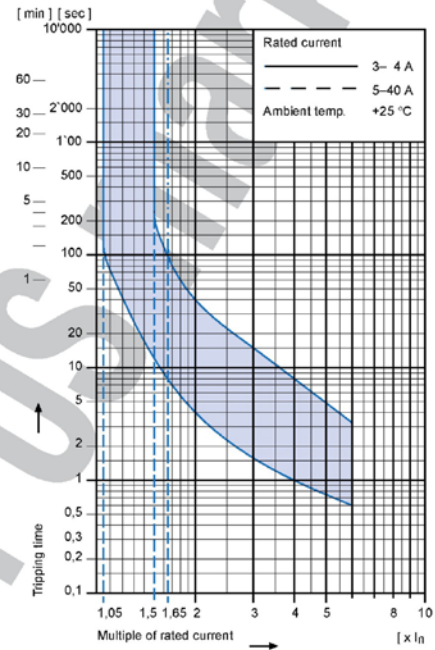

Technical data

Rated voltage U _e	See approvals, page 47E	AC 125; 250 V DC 50 V
Rated current I _n	See approvals, page 47E	3 – 40 A
Conditional short circuit current I _{nc}	PC1, AC 250 V	1000 A
Short circuit capacity I _{cn}	AC 240 V	200 A
Dielectric strength		AC 1500 V
Endurance	Number of cycles at 1,5 x I _n (AC 125 V)	500
Type of actuation	• Reset type	R
Type of tripping	• Thermal • Cycling trip-free	TO
Weight		approx. 24 g

CIRCUIT BREAKERS FOR EQUIPMENT

TS-701

Approvals

		Type TS-701-HT		Type TS-701-HC		
		Rated current range	Rated voltage AC	Rated current range	Rated voltage AC	
	UL	1077	3 – 30 A	250 V	3 – 30 A	250 V
	CSA	C 22,2	3 – 30 A	125 V	3 – 30 A	125 V

Order code



Basic type
 TS-701 Single pole thermal overload protection switch, cycling trip-free

Mounting style
 HT Threaded neck type 3/8" x 28T
 HC Snap-in type (Plastic double spring)

Standard configuration for HT + HC

Actuation type
 Reset type

Terminal type
 6,3 x 0,8 mm quick connect terminals

Rated current
 3 4 5 6 8 10 12 15 16 20 25 28 30
 35 40
 See approvals above

Accessories
 P Plastic knurled nut
 K Metal knurled nut
 H Metal hexagonal nut

Order example

CIRCUIT BREAKERS FOR EQUIPMENT

TS-701

Threaded neck type

Snap-in type

TS-701 HT

TS-701 HC

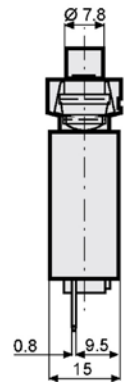
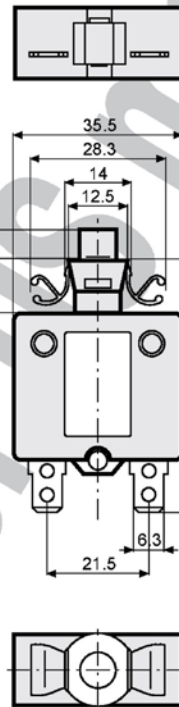
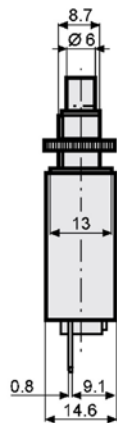
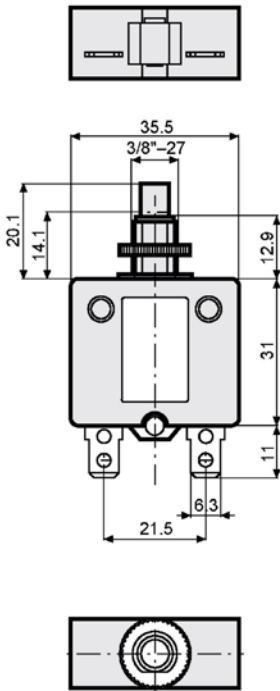

Cut-out

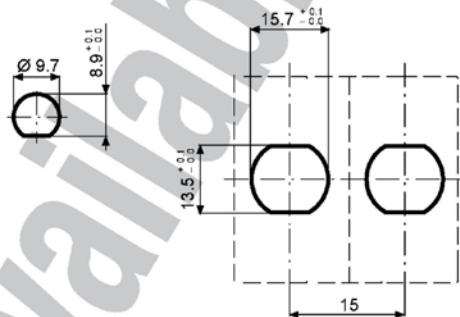

Schematic diagram – accessories

Schematic diagram



Accessories

