



# 45V, 400mA, Low-Quiescent-Current Linear Regulator with Adjustable Reset Delay

MAX5087

## General Description

The MAX5087 high-voltage linear regulator operates from an input voltage of 6.5V to 45V and delivers up to 400mA of output current. The device consumes only 70 $\mu$ A of quiescent current with no load and 11 $\mu$ A in shutdown. The device includes a SET input, that when connected to ground, selects a preset output voltage of 3.3V (MAX5087A) or 5.0V (MAX5087B). Alternatively, the output voltage can be adjusted from 2.5V to 11V by simply connecting SET to the regulator's output through a resistive divider network. The MAX5087 also provides an open-drain, active-low microprocessor ( $\mu$ P) reset output that asserts when the regulator output drops below the preset output voltage threshold. An external capacitor programs the reset timeout period. Other features include an enable input, thermal shutdown, and short-circuit protection.

The MAX5087 operates over the automotive temperature range of -40°C to +125°C and is available in a 16-pin TQFN thermally enhanced package.

## Applications

Automotive  
Industrial  
Home Security/Safety  
Networking

## Features

- ◆ Wide Operating Input Voltage Range (6.5V to 45V)
- ◆ Thermally Enhanced Package Dissipates 2.6W at  $T_A = +70^\circ\text{C}$  (16-Pin TQFN)
- ◆ Guaranteed 400mA Output Current
- ◆ 70 $\mu$ A Quiescent Supply Current
- ◆ Preset 3.3V, 5.0V, or Adjustable 2.5V to 11V Output Voltage
- ◆ Remote Load Sense Capability
- ◆ Enable Input
- ◆ Integrated  $\mu$ P Reset Circuit with Programmable Timeout Period
- ◆ Thermal and Short-Circuit Protection
- ◆ -40°C to +125°C Operating Temperature Range

## Ordering Information

PART	PIN-PACKAGE	PKG CODE	OUTPUT VOLTAGE (V)
MAX5087AATE+	16 TQFN-EP*	T1655-2	3.3
MAX5087BATE+	16 TQFN-EP*	T1655-2	5.0

**Note:** All devices are specified over the -40°C to +125°C operating temperature range.

\*EP = Exposed paddle.

+Denotes lead-free package.

## Pin Configuration

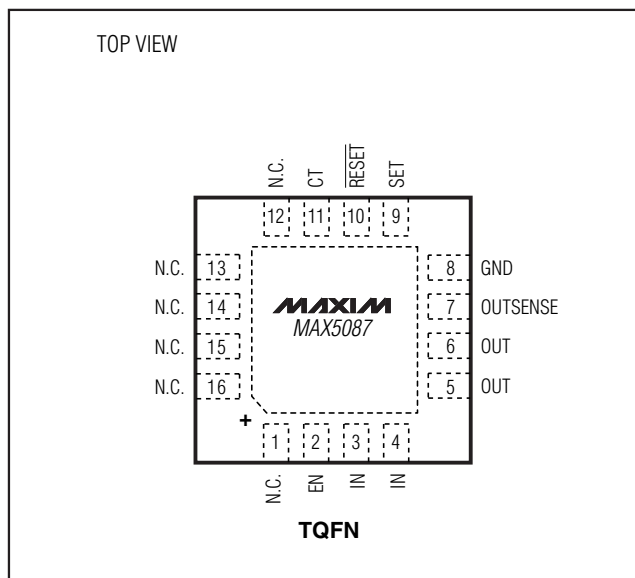

# 45V, 400mA, Low-Quiescent-Current Linear Regulator with Adjustable Reset Delay

## ABSOLUTE MAXIMUM RATINGS

IN to GND (do not exceed package power dissipation).....	-0.3V to +50V	Continuous Power Dissipation ( $T_A = +70^\circ\text{C}$ )	
IN to GND ( $T \leq 300\text{ms}$ , $I_{\text{OUT}} \leq 250\text{mA}$ ).....	-0.3V to +42V	16-Pin TQFN (derate 33.3mW/ $^\circ\text{C}$ above $+70^\circ\text{C}$ ).....	2666mW*
EN to GND.....	-0.3V to +50V	Thermal Resistance (Note 1)	
RESET, OUT, OUTSENSE to GND.....	-0.3V to +12V	$\theta_{\text{JA}}$ , 16-Pin TQFN.....	30.0 $^\circ\text{C}/\text{W}$
IN to OUT.....	-0.3V to +50V	$\theta_{\text{JC}}$ , 16-Pin TQFN.....	2 $^\circ\text{C}/\text{W}$
CT, SET TO GND.....	-0.3V to +35V	Operating Temperature Range.....	-40 $^\circ\text{C}$ to +125 $^\circ\text{C}$
Short-Circuit Duration ( $V_{\text{IN}} \leq 14\text{V}$ ).....	Continuous	Junction Temperature.....	+150 $^\circ\text{C}$
Maximum Current into Any Pin (Except IN, OUT).....	$\pm 20\text{mA}$	Storage Temperature Range.....	-60 $^\circ\text{C}$ to +150 $^\circ\text{C}$
		Lead Temperature (soldering, 10s).....	+300 $^\circ\text{C}$

**Note 1:** Package thermal resistances were obtained using the method described in JEDEC specification JESD51-7 using a four-layer board. For detailed information on thermal considerations, refer to [www.maxim-ic.com/thermal-tutorial](http://www.maxim-ic.com/thermal-tutorial).

Stresses beyond those listed under "Absolute Maximum Ratings" may cause permanent damage to the device. These are stress ratings only, and functional operation of the device at these or any other conditions beyond those indicated in the operational sections of the specifications is not implied. Exposure to absolute maximum rating conditions for extended periods may affect device reliability.

## ELECTRICAL CHARACTERISTICS

( $V_{\text{IN}} = 14\text{V}$ ,  $I_{\text{OUT}} = 1\text{mA}$ ,  $C_{\text{IN}} = 47\mu\text{F}$  (low ESR),  $C_{\text{OUT}} = 15\mu\text{F}$ ,  $V_{\text{EN}} = 2.4\text{V}$ ,  $10\text{k}\Omega$  from  $\overline{\text{RESET}}$  to OUT,  $T_A = T_J = -40^\circ\text{C}$  to  $+125^\circ\text{C}$ , unless otherwise noted. Typical specifications are at  $T_A = +25^\circ\text{C}$ .) (Note 2)

PARAMETER	SYMBOL	CONDITIONS		MIN	TYP	MAX	UNITS
Input Voltage Range	$V_{\text{IN}}$	$V_{\text{IN}} \geq V_{\text{OUT}} + 1.5\text{V}$		6.5		45.0	V
Supply Current	$I_{\text{Q}}$	Measured at GND, SET = GND	$I_{\text{OUT}} = 0$		70	150	$\mu\text{A}$
			$I_{\text{OUT}} = 400\text{mA}$		5300		
Shutdown Supply Current	$I_{\text{SHDN}}$	$V_{\text{EN}} \leq 0.4\text{V}$			11	21	$\mu\text{A}$
<b>REGULATOR</b>							
Guaranteed Output Current	$I_{\text{OUT}}$	$V_{\text{IN}} = 6.5\text{V}$ , $V_{\text{OUT}} = 5.0\text{V}$		400			mA
Output Voltage (Note 3)	$V_{\text{OUT}}$	SET = GND, 5V version	$6.5\text{V} \leq V_{\text{IN}} \leq 25\text{V}$ , $5\text{mA} \leq I_{\text{OUT}} \leq 400\text{mA}$	4.87	5	5.13	V
			$6.5\text{V} \leq V_{\text{IN}} \leq 45\text{V}$ , $5\text{mA} \leq I_{\text{OUT}} \leq 100\text{mA}$	4.850	5	5.150	
		SET = GND, 3.3V version	$6.5\text{V} \leq V_{\text{IN}} \leq 25\text{V}$ , $5\text{mA} \leq I_{\text{OUT}} \leq 400\text{mA}$	3.208	3.3	3.392	
			$6.5\text{V} \leq V_{\text{IN}} \leq 45\text{V}$ , $5\text{mA} \leq I_{\text{OUT}} \leq 100\text{mA}$	3.208	3.3	3.392	
		$I_{\text{OUT}} = 5\text{mA}$ , adjustable range			2.5		
Dropout Voltage	$\Delta V_{\text{DO}}$	$I_{\text{OUT}} = 400\text{mA}$ , $V_{\text{OUT}} = 5\text{V}$ (Note 4)			0.9	2.2	V
Startup Response Time		Rising edge of $V_{\text{IN}}$ to $V_{\text{OUT}}$ , $R_{\text{L}} = 500\Omega$ , SET = GND (Note 5)			400		$\mu\text{s}$
Line Regulation	$\frac{\Delta V_{\text{OUT}}}{\Delta V_{\text{IN}}}$	$8\text{V} \leq V_{\text{IN}} \leq 45\text{V}$	5V version	-1		+1	mV/V
			3.3V version	-0.5		+0.5	
Enable Voltage	$V_{\text{EN}}$	$V_{\text{EN}} = \text{high}$ , regulator on		2.4			V
		$V_{\text{EN}} = \text{low}$ , regulator off				0.4	

# 45V, 400mA, Low-Quiescent-Current Linear Regulator with Adjustable Reset Delay

MAX5087

## ELECTRICAL CHARACTERISTICS (continued)

( $V_{IN} = 14V$ ,  $I_{OUT} = 1mA$ ,  $C_{IN} = 47\mu F$  (low ESR),  $C_{OUT} = 15\mu F$ ,  $V_{EN} = 2.4V$ ,  $10k\Omega$  from  $\overline{RESET}$  to OUT,  $T_A = T_J = -40^\circ C$  to  $+125^\circ C$ , unless otherwise noted. Typical specifications are at  $T_A = +25^\circ C$ .) (Note 2)

PARAMETER	SYMBOL	CONDITIONS	MIN	TYP	MAX	UNITS
Enable Input Current	$I_{EN}$	$V_{EN} = 2.4V$		0.35		$\mu A$
		$V_{EN} = 14V$		3.4		
SET Reference Voltage	$V_{SET}$		1.200	1.235	1.260	V
SET Input Leakage Current	$I_{SET}$		-100	+0.5	+100	nA
Load Regulation	$\Delta V_{OUT} / \Delta I_{OUT}$	$I_{OUT} = 1mA$ to 400mA (Note 3)		0.1	0.35	$\Omega$
Power-Supply Rejection Ratio	PSRR	$I_{OUT} = 10mA$ , $f = 100Hz$ , 500mVp-p, $V_{OUT} = 5V$		70		dB
Short-Circuit Current	$I_{SC}$	$V_{IN} < 14V$ (Note 6)		640		mA
Thermal Shutdown Temperature	$T_{J(SHDN)}$			175		$^\circ C$
Thermal Shutdown Hysteresis	$\Delta T_{J(SHDN)}$			25		$^\circ C$
$\overline{RESET}$ Voltage Threshold	$V_{\overline{RESET}}$		89	92	94	% $V_{OUT}$
$\overline{RESET}$ Threshold Hysteresis	$V_{RHYST}$			2		% $V_{OUT}$
$\overline{RESET}$ Output Low Voltage	$V_{RL}$	$I_{SINK} = 1mA$			0.4	V
$\overline{RESET}$ Output Leakage Current	$I_{RH}$	$V_{\overline{RESET}} = 5V$			1	$\mu A$
$\overline{RESET}$ Output Minimum Timeout Period		When $V_{OUT}$ reaches $\overline{RESET}$ threshold, $C_{CT} = Open$		15		$\mu s$
ENABLE to $\overline{RESET}$ Minimum Timeout Period		When EN goes high, $C_{CT} = open$		170		$\mu s$
Delay Comparator Threshold (Rising)			1.196	1.230	1.264	V
Delay Comparator Threshold Hysteresis				100		mV
CT Charge Current			1	2	4	$\mu A$
CT Discharge Current				5		mA

**Note 2:** Limits at  $T_A = -40^\circ C$  are guaranteed by design.

**Note 3:** Output voltage is tested using a pulsed load current of less than 50ms duration.

**Note 4:** Dropout voltage is defined as  $(V_{IN} - V_{OUT})$  when  $V_{OUT}$  is 100mV below the value of  $V_{OUT}$  for  $V_{IN} = V_{OUT} + 3V$ .

**Note 5:** Startup time measured from 50% of  $V_{IN}$  to 90% of  $V_{OUT}$ .

**Note 6:** Continuous short-circuit protection for  $V_{IN} > 14V$  not guaranteed.

# 45V, 400mA, Low-Quiescent-Current Linear Regulator with Adjustable Reset Delay

## Typical Operating Characteristics

( $V_{IN} = V_{EN} = 14V$ ,  $C_{IN} = 47\mu F$  (low ESR),  $C_{OUT} = 15\mu F$ ,  $V_{OUT} = 5V$ ,  $SET = GND$ ,  $T_A = +25^\circ C$ , unless otherwise specified.)

**OUTPUT VOLTAGE vs. INPUT VOLTAGE**

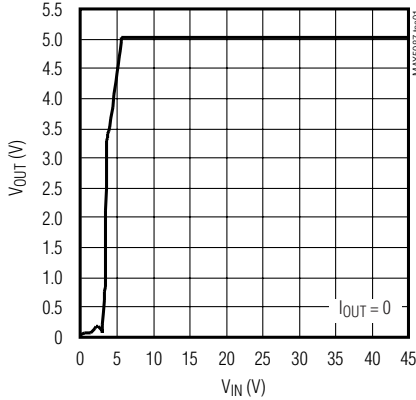

**NO-LOAD SUPPLY CURRENT vs. TEMPERATURE**

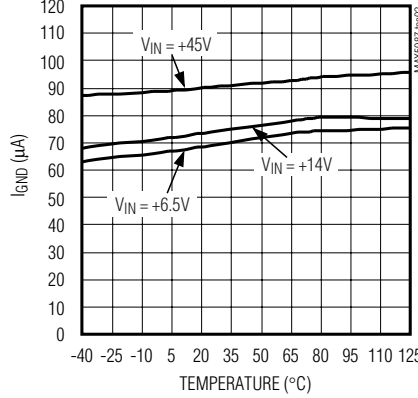

**SHUTDOWN SUPPLY CURRENT vs. TEMPERATURE**

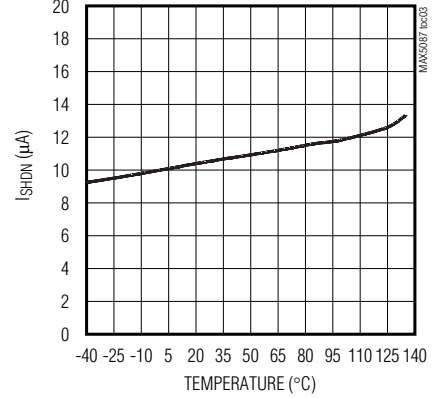

**OUTPUT VOLTAGE vs. TEMPERATURE**

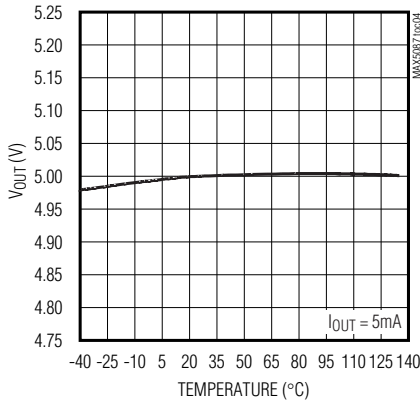

**GROUND CURRENT vs. TEMPERATURE (PULSED LOAD)**

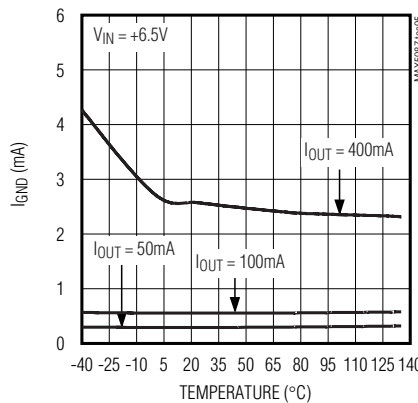

**OUTPUT VOLTAGE vs. LOAD CURRENT AND TEMPERATURE**

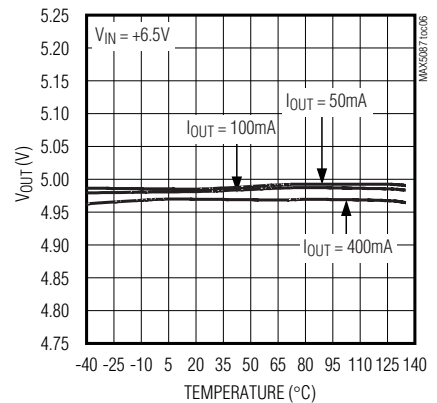

**DROPOUT VOLTAGE vs. LOAD CURRENT**

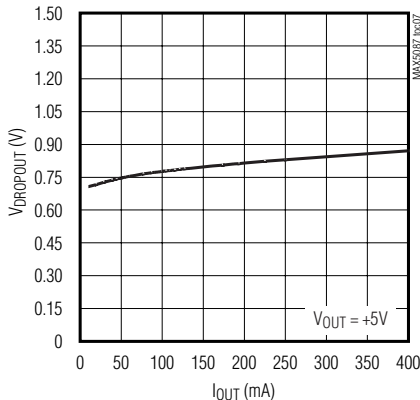

**POWER-SUPPLY REJECTION RATIO vs. FREQUENCY**

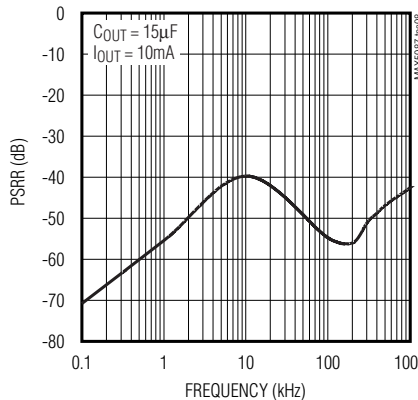

**LOAD-TRANSIENT RESPONSE**

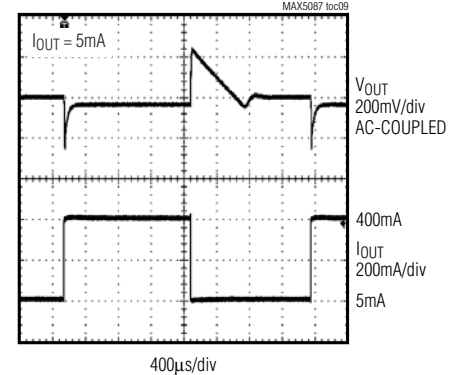

# 45V, 400mA, Low-Quiescent-Current Linear Regulator with Adjustable Reset Delay

**MAX5087**

## Typical Operating Characteristics (continued)

( $V_{IN} = V_{EN} = 14V$ ,  $C_{IN} = 47\mu F$  (low ESR)  $C_{OUT} = 15\mu F$ ,  $V_{OUT} = 5V$ ,  $SET = GND$ ,  $T_A = +25^\circ C$ , unless otherwise specified.)

**INPUT VOLTAGE STEP RESPONSE**

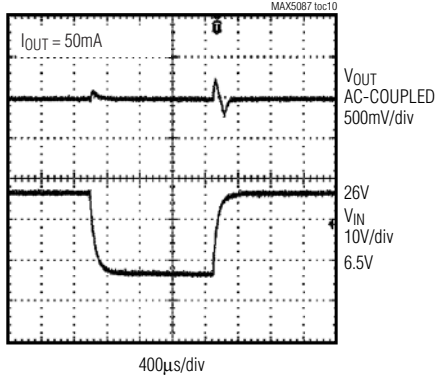

**STARTUP RESPONSE**

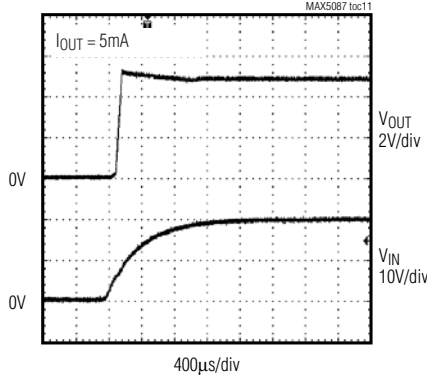

**ENABLE STARTUP RESPONSE**

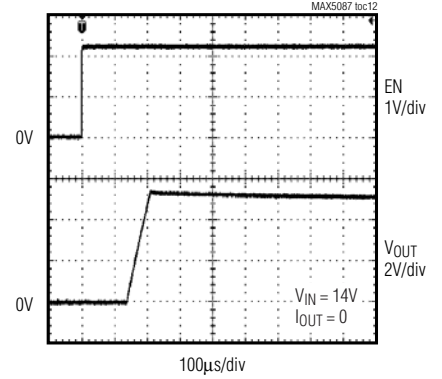

**ENABLE STARTUP RESPONSE**

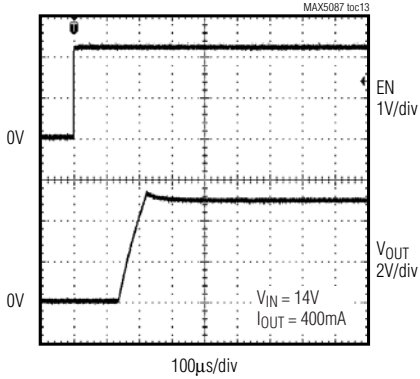

**ENABLE STARTUP RESPONSE**

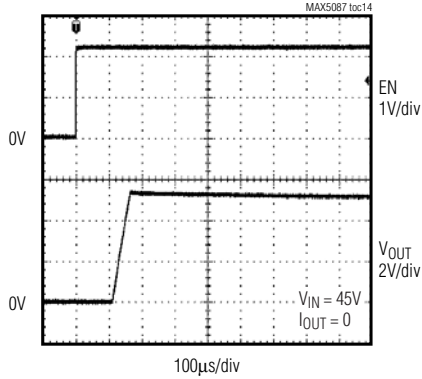

**ENABLE STARTUP RESPONSE**

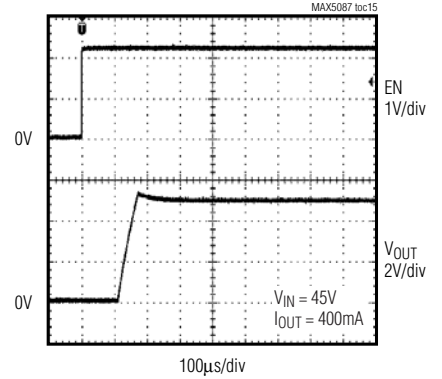

**SHUTDOWN RESPONSE**

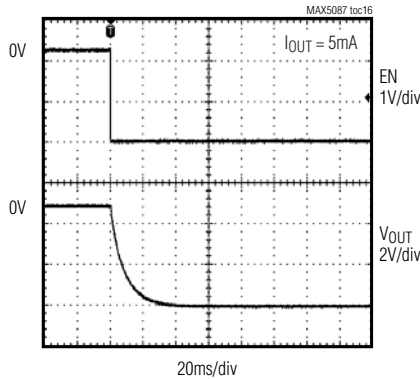

**GROUND CURRENT DISTRIBUTION  
( $T_A = -40^\circ C$ )**

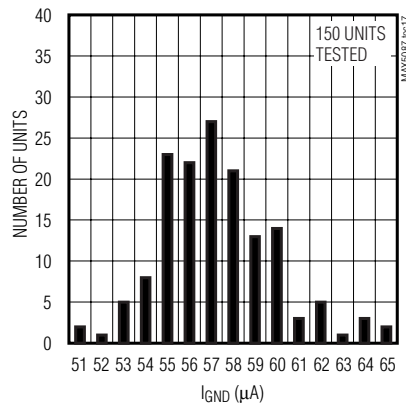

**GROUND CURRENT DISTRIBUTION  
( $T_A = +125^\circ C$ )**

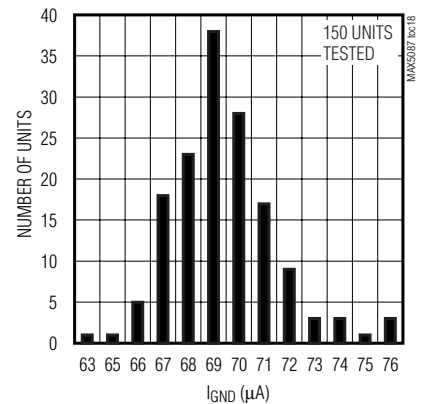

# 45V, 400mA, Low-Quiescent-Current Linear Regulator with Adjustable Reset Delay

## Pin Description

PIN	NAME	FUNCTION
1, 12–16	N.C.	No Connection. Not internally connected.
2	EN	Enable Input. Drive EN high to turn on the regulator. Force EN low to place the device in shutdown mode.
3, 4	IN	Regulator Input. Supply voltage ranges from 6.5V to 45V. Bypass IN to GND with a low-ESR 47 $\mu$ F electrolytic capacitor.
5, 6	OUT	Regulator Output. Connect at least a 15 $\mu$ F low-ESR capacitor from OUT to GND.
7	OUTSENSE	Regulator Output Feedback Point. OUTSENSE must be connected to OUT for fixed output voltage versions. Leave OUTSENSE open for adjustable output voltage version.
8	GND	Ground
9	SET	Feedback Regulation Set Point. Connect SET to GND for a fixed 3.3V output (MAX5087A) or 5.0V output (MAX5087B). Connect an external resistive divider network from OUTSENSE to SET to GND to adjust the output voltage from 2.5V to 11V.
10	$\overline{\text{RESET}}$	Open-Drain Active-Low Reset Output. Connect a 10k $\Omega$ pullup resistor from $\overline{\text{RESET}}$ to any supply voltage up to 11V to create a logic output.
11	CT	Reset Timeout Setting Connection. A 2 $\mu$ A charging current is available at CT. Connect a capacitor from CT to GND to set the reset timeout period (see the <i>Adjustable Reset Timeout Period (CT)</i> section).
—	EP	Exposed Paddle. Connect externally to a large ground plane to aid heat dissipation. Do not use EP as a ground connection.

# 45V, 400mA, Low-Quiescent-Current Linear Regulator with Adjustable Reset Delay

MAX5087

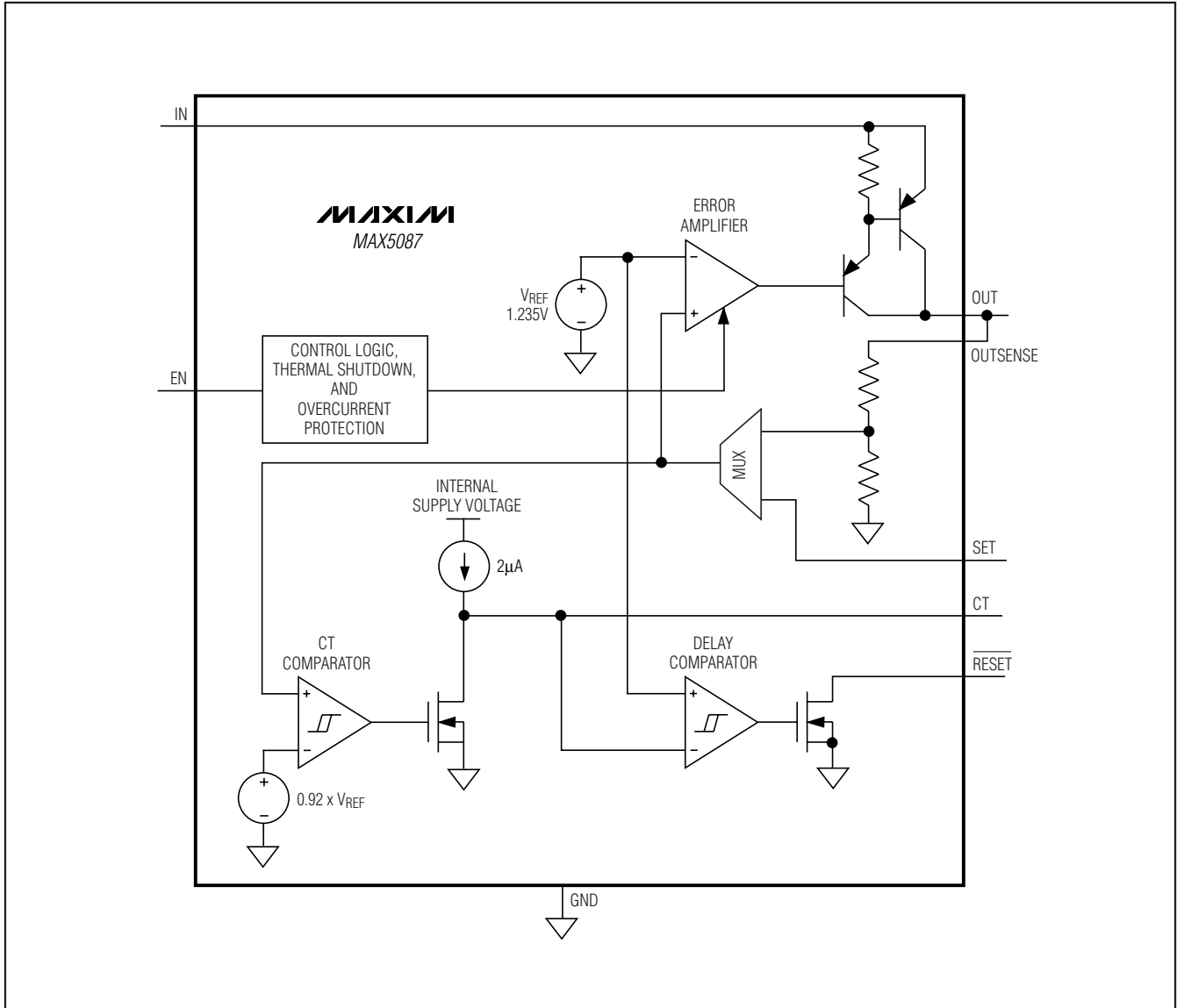

Figure 1. Functional Diagram

# 45V, 400mA, Low-Quiescent-Current Linear Regulator with Adjustable Reset Delay

## Detailed Description

The MAX5087 high-voltage linear regulator includes an integrated  $\mu\text{P}$  reset circuit with an adjustable reset timeout period (see the *Adjustable Reset Timeout Period (CT)* section). The device guarantees a 400mA load current and is available with a preset output voltage of 3.3V (MAX5087A) or 5V (MAX5087B). Both devices can be configured to provide an adjustable output voltage from 2.5V to 11V. The internal reset circuit monitors the regulator output voltage and asserts  $\overline{\text{RESET}}$  low when the regulator output falls below the reset threshold voltage. Other features include an enable (regulator control input), 21 $\mu\text{A}$  (max) shutdown current, short-circuit protection (see the *Output Short-Circuit Current Limit* section), and thermal shutdown (see the *Thermal Protection* section).

### Regulator

The MAX5087 accepts an input voltage range from 6.5V to 45V and offers a fixed output voltage of 3.3V or 5V. For an adjustable output voltage operation, use an external resistive divider network connected between OUT, SET, and GND (see Figure 2).

### Enable Input (EN)

EN is a logic-level enable input that turns the device on/off. Drive EN high to turn on the device and drive EN low to place the device in shutdown. The MAX5087 draws 11 $\mu\text{A}$  (typ) of supply current when in shutdown. EN withstands voltages up to +45V, allowing EN to be connected to IN for an always-on operation.

### Remote Sensing (OUTSENSE)

The 3.3V (MAX5087A) and 5V (MAX5087B) output voltage versions connect OUTSENSE for load voltage sensing. Leave OUTSENSE open when using adjustable output voltage version.

### Reset Output ( $\overline{\text{RESET}}$ )

A supervisor circuit is fully integrated in the MAX5087 and uses the same reference voltage as the regulator.  $\overline{\text{RESET}}$  goes low if  $V_{\text{OUT}}$  drops below the preset output voltage threshold, and remains low at least for the timeout period after  $V_{\text{OUT}}$  rises above the reset voltage threshold.

### Adjustable Reset Timeout Period (CT)

The MAX5087 features a user-adjustable reset timeout. Connect a capacitor from CT to GND to set the reset

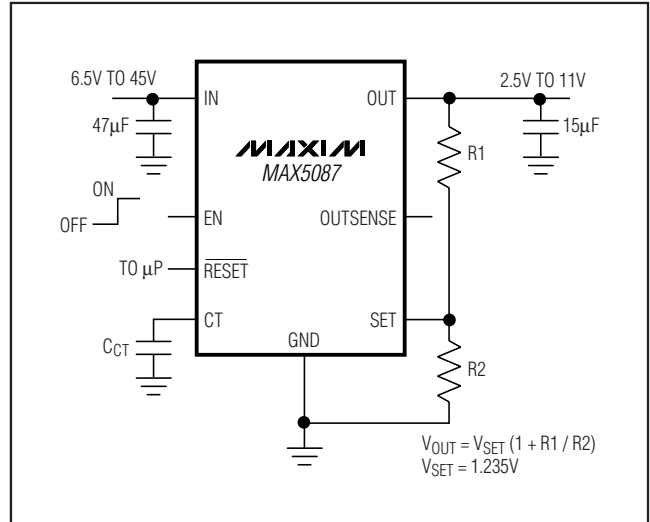

Figure 2. Setting the Adjustable Output Voltage

timeout period (see Figure 2) and use the following equation to calculate the timeout period:

$$t_{\text{RP}} = C_{\text{CT}} \times 0.6175 \times 10^6 \text{ (s)}$$

where  $C_{\text{CT}}$  is the value of the external capacitor connected from CT to GND.

### Thermal Protection

When the junction temperature exceeds  $T_{\text{J}} = +175^{\circ}\text{C}$ , an internal thermal sensor signals the shutdown logic, which turns off the pass transistor, allowing the IC to cool. The thermal sensor turns the pass transistor on again after the IC's junction temperature cools by  $25^{\circ}\text{C}$ , resulting in a cycled output during continuous thermal-overload conditions. Thermal protection protects the MAX5087 in the event of fault conditions. During continuous operation, do not exceed the absolute maximum junction temperature rating of  $T_{\text{J}} = +150^{\circ}\text{C}$ .

### Output Short-Circuit Current Limit

The MAX5087 features a current limit. The output can be shorted to GND for an indefinite period of time (for  $V_{\text{IN}} < 14\text{V}$ ) without damage to the device. Continuous output short-circuit protection is only guaranteed for  $V_{\text{IN}} < 14\text{V}$ .



# 45V, 400mA, Low-Quiescent-Current Linear Regulator with Adjustable Reset Delay

MAX5087

## Applications Information

### Output-Voltage Selection

The MAX5087 features a Dual Mode™ operation, in either a preset-voltage mode or an adjustable mode. In preset-voltage mode, internal feedback resistors set the MAX5087's output voltage to +3.3V or +5V. Select preset-voltage mode by connecting SET to ground. In adjustable mode, select an output between +2.5V and +11V using two external resistors connected as a voltage-divider to SET (Figure 2). Set the output voltage using the following equation:

$$V_{OUT} = V_{SET} \times \left(1 + \frac{R1}{R2}\right)$$

where  $V_{SET} = 1.235V$  and  $R2$  is chosen to be  $< 100k\Omega$ .

### Available Output-Current Calculation

The MAX5087 high-voltage regulator provides up to 400mA of output current. The input voltage extends to +45V. Package power dissipation limits the amount of output current available for a given input/output voltage and ambient temperature. Figure 3 shows the maximum power dissipation curve for these devices. The graph assumes that the exposed paddle of the MAX5087 package is set up per JEDEC 51 (multilayer board) specifications.

Use Figure 3 to determine the allowable package dissipation ( $P_D$ ) for a given ambient temperature. Alternately, use the following formulas to calculate the allowable package dissipation. Note that for the examples shown below, the electrical characteristic limits are guaranteed up to  $T_J = +125^\circ C$  (max).

$$P_D = \begin{cases} 2.666W & \text{for } T_A \leq +70^\circ C \\ 2.666W - 0.0333 \frac{W}{^\circ C} \times (T_A - 70^\circ C) & \text{for } +70^\circ C < T_A \leq +125^\circ C \end{cases}$$

After determining the allowable package dissipation calculate the maximum output current using the following formula:

$$I_{OUT(MAX)} \equiv \frac{P_D}{V_{IN} - V_{OUT}} \leq 400mA$$

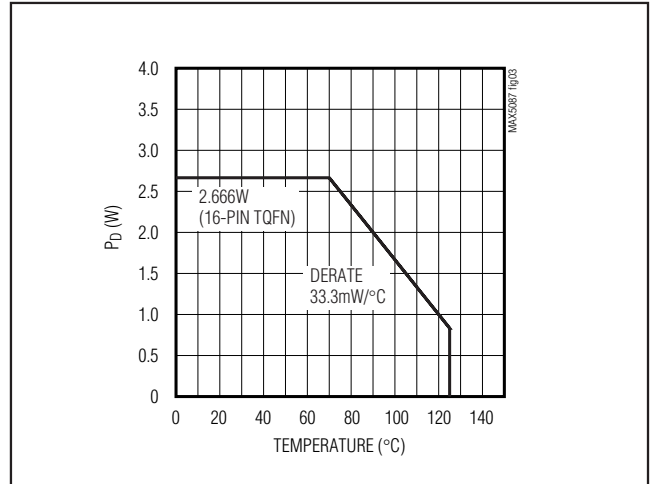

Figure 3. Calculated Maximum Power Dissipation vs. Temperature

The above equations do not include the negligible power dissipation from self-heating due to the IC ground current.

### Example 1:

$$T_A = +95^\circ C$$

$$V_{IN} = +14V$$

$$V_{OUT} = +5V$$

Find the maximum allowable output current. First calculate package dissipation at the given temperature as follows:

$$P_D = 2.666W - 0.0333 \frac{W}{^\circ C} (95^\circ C - 70^\circ C) = 1.8335W$$

Then determine the maximum output current:

$$I_{OUT(MAX)} = \frac{(1.8335W)}{(14V) - (5V)} = 203mA$$

### Example 2:

$$T_A = +125^\circ C$$

$$V_{IN} = +14V$$

$$V_{OUT} = +5V$$

Dual Mode is a trademark of Maxim Integrated Products, Inc.

# 45V, 400mA, Low-Quiescent-Current Linear Regulator with Adjustable Reset Delay

Calculate package dissipation at the given temperature as follows:

$$P_D = 2.666W - 0.0333 \frac{W}{^\circ C} (125^\circ C - 70^\circ C) = 0.8345W$$

And establish the maximum current:

$$I_{OUT(MAX)} = \frac{(1.191W)}{(14V) - (5V)} = 92.7mA$$

### Example 3:

$T_A = +50^\circ C$

$V_{IN} = +14V$

$V_{OUT} = +10V$

Calculate package dissipation at the given temperature as follows:

$$P_D = 2.666W$$

And find the maximum output current:

$$I_{OUT(MAX)} = \frac{(2.666W)}{(14V) - (10V)} = 666mA \Rightarrow I_{OUT(MAX)} = 400mA$$

In example 3 the maximum output current is calculated as 666mA, however, the maximum output current cannot exceed 400mA.

Use Figure 4 to quickly determine maximum allowable output current for selected ambient temperatures.

### Output-Capacitor Selection and Regulator Stability

For stable operation over the full temperature range and with load currents up to 400mA, use a 15µF (min) output capacitor with an ESR < 0.25Ω. To reduce noise and improve load-transient response, stability, and power-supply rejection use larger output capacitor values such as 22µF.

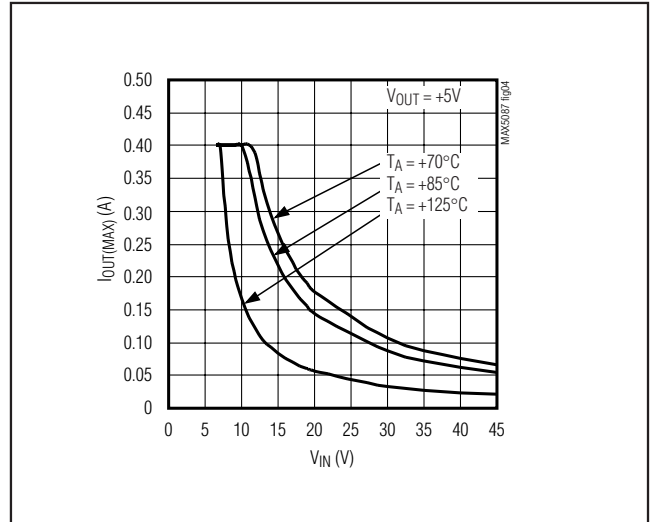

Figure 4. Maximum Output Current vs. Input Voltage (16-Pin TQFN)

Some ceramic capacitor dielectrics exhibit large capacitance and ESR variation with temperature. For capacitor dielectrics such as Y5V, use 22µF or more to ensure stability at temperatures below -10°C. With X7R or X5R dielectrics, 15µF should be sufficient at all operating temperatures. To improve power supply rejection and transient response, use a minimum 47µF low-ESR capacitor from IN to GND.

### Chip Information

PROCESS: BiCMOS

# 45V, 400mA, Low-Quiescent-Current Linear Regulator with Adjustable Reset Delay

## Package Information

(The package drawing(s) in this data sheet may not reflect the most current specifications. For the latest package outline information, go to [www.maxim-ic.com/packages](http://www.maxim-ic.com/packages).)

MAX5087

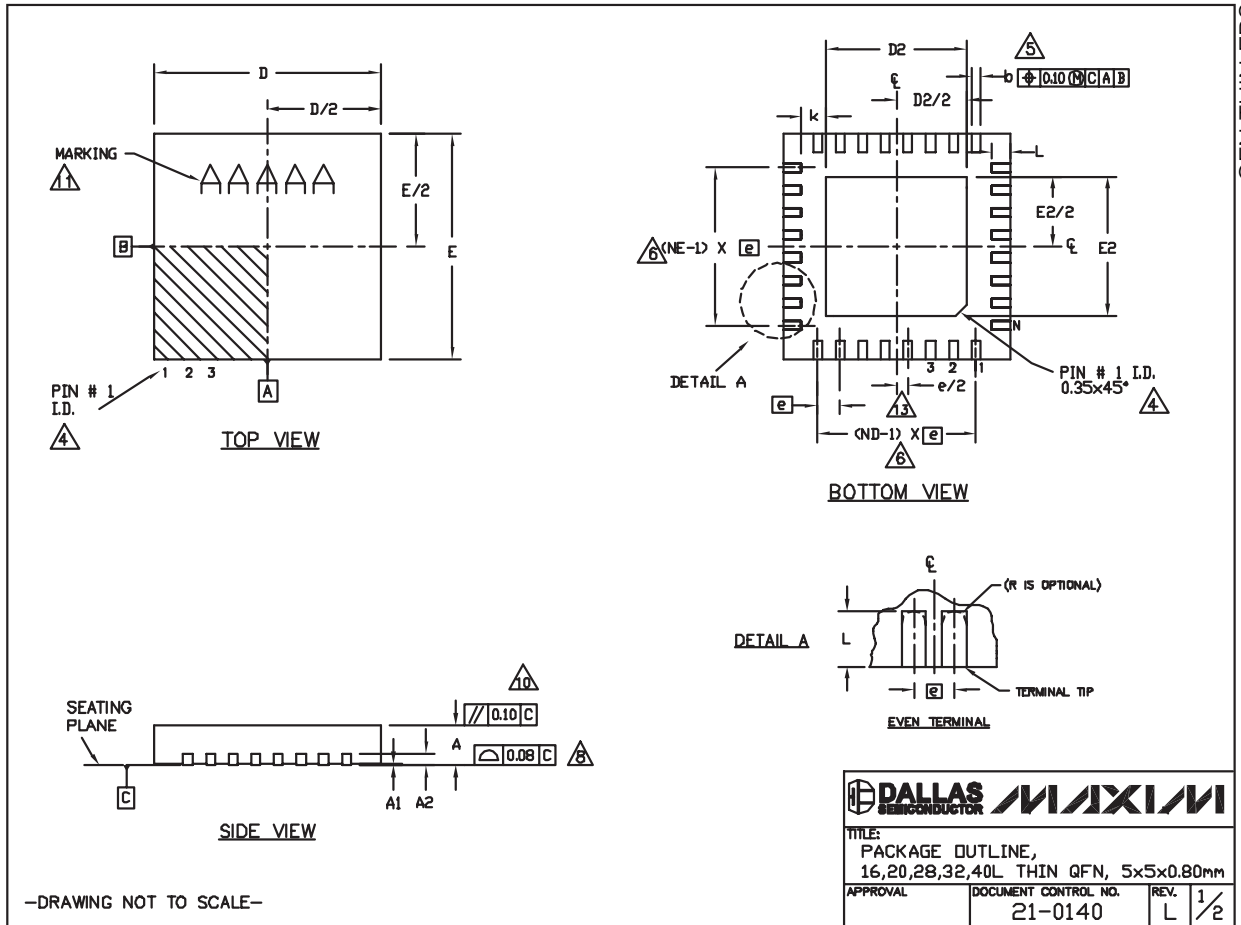

# 45V, 400mA, Low-Quiescent-Current Linear Regulator with Adjustable Reset Delay

## Package Information (continued)

(The package drawing(s) in this data sheet may not reflect the most current specifications. For the latest package outline information, go to [www.maxim-ic.com/packages](http://www.maxim-ic.com/packages).)

COMMON DIMENSIONS															
PKG.	16L 5x5			20L 5x5			28L 5x5			32L 5x5			40L 5x5		
SYMBOL	MIN.	NOM.	MAX.	MIN.	NOM.	MAX.	MIN.	NOM.	MAX.	MIN.	NOM.	MAX.	MIN.	NOM.	MAX.
A	0.70	0.75	0.80	0.70	0.75	0.80	0.70	0.75	0.80	0.70	0.75	0.80	0.70	0.75	0.80
A1	0	0.02	0.05	0	0.02	0.05	0	0.02	0.05	0	0.02	0.05	0	0.02	0.05
A2	0.20 REF.			0.20 REF.			0.20 REF.			0.20 REF.			0.20 REF.		
b	0.25	0.30	0.35	0.25	0.30	0.35	0.20	0.25	0.30	0.20	0.25	0.30	0.15	0.20	0.25
D	4.90	5.00	5.10	4.90	5.00	5.10	4.90	5.00	5.10	4.90	5.00	5.10	4.90	5.00	5.10
E	4.90	5.00	5.10	4.90	5.00	5.10	4.90	5.00	5.10	4.90	5.00	5.10	4.90	5.00	5.10
e	0.80 BSC.			0.65 BSC.			0.50 BSC.			0.50 BSC.			0.40 BSC.		
k	0.25	-	-	0.25	-	-	0.25	-	-	0.25	-	-	0.25	-	-
L	0.30	0.40	0.50	0.45	0.55	0.65	0.45	0.55	0.65	0.30	0.40	0.50	0.30	0.40	0.50
N	16			20			28			32			40		
ND	4			5			7			8			10		
NE	4			5			7			8			10		
JEDEC	VHBB			WHHC			WHHD-1			WHHD-2			-----		

**NOTES:**

1. DIMENSIONING & TOLERANCING CONFORM TO ASME Y14.5M-1994.
2. ALL DIMENSIONS ARE IN MILLIMETERS. ANGLES ARE IN DEGREES.
3. N IS THE TOTAL NUMBER OF TERMINALS.
4. THE TERMINAL #1 IDENTIFIER AND TERMINAL NUMBERING CONVENTION SHALL CONFORM TO JE3D 95-1 SPP-012. DETAILS OF TERMINAL #1 IDENTIFIER ARE OPTIONAL, BUT MUST BE LOCATED WITHIN THE ZONE INDICATED. THE TERMINAL #1 IDENTIFIER MAY BE EITHER A MOLD OR MARKED FEATURE.
5. DIMENSION b APPLIES TO METALLIZED TERMINAL AND IS MEASURED BETWEEN 0.25 mm AND 0.30 mm FROM TERMINAL TIP.
6. ND AND NE REFER TO THE NUMBER OF TERMINALS ON EACH D AND E SIDE RESPECTIVELY.
7. DEPOPULATION IS POSSIBLE IN A SYMMETRICAL FASHION.
8. COPLANARITY APPLIES TO THE EXPOSED HEAT SINK SLUG AS WELL AS THE TERMINALS.
9. DRAWING CONFORMS TO JEDEC MO220, EXCEPT EXPOSED PAD DIMENSION FOR T2855-3, T2855-6, T4055-1 AND T4055-2.
10. WARPAGE SHALL NOT EXCEED 0.10 mm.
11. MARKING IS FOR PACKAGE ORIENTATION REFERENCE ONLY.
12. NUMBER OF LEADS SHOWN ARE FOR REFERENCE ONLY.
13. LEAD CENTERLINES TO BE AT TRUE POSITION AS DEFINED BY BASIC DIMENSION 'e', ±0.05.
14. ALL DIMENSIONS APPLY TO BOTH LEADED AND P&F FREE PARTS.

-DRAWING NOT TO SCALE-

EXPOSED PAD VARIATIONS						
PKG. CODES	D2			E2		
	MIN.	NOM.	MAX.	MIN.	NOM.	MAX.
T1655-2	3.00	3.10	3.20	3.00	3.10	3.20
T1655-3	3.00	3.10	3.20	3.00	3.10	3.20
T1655N-1	3.00	3.10	3.20	3.00	3.10	3.20
T2055-3	3.00	3.10	3.20	3.00	3.10	3.20
T2055-4	3.00	3.10	3.20	3.00	3.10	3.20
T2055-5	3.15	3.25	3.35	3.15	3.25	3.35
T2055MN-5	3.15	3.25	3.35	3.15	3.25	3.35
T2855-3	3.15	3.25	3.35	3.15	3.25	3.35
T2855-4	2.60	2.70	2.80	2.60	2.70	2.80
T2855-5	2.60	2.70	2.80	2.60	2.70	2.80
T2855-6	3.15	3.25	3.35	3.15	3.25	3.35
T2855-7	2.60	2.70	2.80	2.60	2.70	2.80
T2855-8	3.15	3.25	3.35	3.15	3.25	3.35
T2855N-1	3.15	3.25	3.35	3.15	3.25	3.35
T3255-3	3.00	3.10	3.20	3.00	3.10	3.20
T3255-4	3.00	3.10	3.20	3.00	3.10	3.20
T3255M-4	3.00	3.10	3.20	3.00	3.10	3.20
T3255-5	3.00	3.10	3.20	3.00	3.10	3.20
T3255N-1	3.00	3.10	3.20	3.00	3.10	3.20
T4055-1	3.40	3.50	3.60	3.40	3.50	3.60
T4055-2	3.40	3.50	3.60	3.40	3.50	3.60
T4055MN-1	3.40	3.50	3.60	3.40	3.50	3.60

TITLE: PACKAGE OUTLINE, 16,20,28,32,40L THIN QFN, 5x5x0.80mm	
APPROVAL	DOCUMENT CONTROL NO. 21-0140
REV. L	2/2

# 45V, 400mA, Low-Quiescent-Current Linear Regulator with Adjustable Reset Delay

## Revision History

REVISION NUMBER	REVISION DATE	DESCRIPTION	PAGES CHANGED
0	2/06	Initial release	—
1	4/06	Updated <i>Ordering Information</i> and <i>Electrical Characteristics</i> tables.	1-3
2	7/06	Updated <i>Electrical Characteristics</i> table.	2
3	2/08	Corrected errors in data sheet, reduced operating range, and removed products from <i>Ordering Information</i> table.	1-13

MAX5087

Maxim cannot assume responsibility for use of any circuitry other than circuitry entirely embodied in a Maxim product. No circuit patent licenses are implied. Maxim reserves the right to change the circuitry and specifications without notice at any time.

Maxim Integrated Products, 120 San Gabriel Drive, Sunnyvale, CA 94086 408-737-7600 \_\_\_\_\_ 13