

INTEGRATED SWITCHER Package Outline

Features

- 7-pin SIP type full molded package, optimum IC for low-height SMPS.
- Oscillator is provided on the monolithic control with adopting On-Chip Trimming Technology
- Small temperature characteristics variation by adopting a comparator to compensate for temperature on the control part.
- Low start-up circuit current (100uA max)
- Avalanche energy guaranteed MOSFET with high VDSS
 - The built-in power MOSFET simplifies the surge absorption circuit since the MOSFET guarantees the avalanche energy.
 - No VDSS de-rating is required.
- Built-in constant voltage drive circuit
- Built-in step drive circuit
- Built-in low frequency PWM mode (22 kHz)
- UVLO Burst Standby
- Two operational modes by auto switching functions according to load
 - For middle-heavy load operation : QR mode
 - For light-middle load operation : 1 Bottom Skip mode
- Various kinds of protection functions
 - Pulse-by-Pulse Overcurrent Protection (OCP)
 - Overvoltage Protection with Latch mode (OVP)
 - Overload Protection with Latch mode (OLP)
 - The maximum limit of on-time



TO-220 Fullpack (7 Lead)

Key Specifications

Type	MOSFET VDSS(V)	RDS(ON) MAX	AC input(V)	Pout(W) Note 1
IRIS-X6757	650		230 15%	300
			85 to 264	180

Description

IRIS-X6757 is a hybrid IC consisting of a power MOSFET and a controller IC, designed for Quasi-Resonant (including low frequency PWM) fly-back converter type SMPS (Switching Mode Power Supply) applications. This IC realizes high efficiency, low noise, downsizing and standardizing of a power supply system reducing external component count and simplifying the circuit design.

Typical Connection Diagram

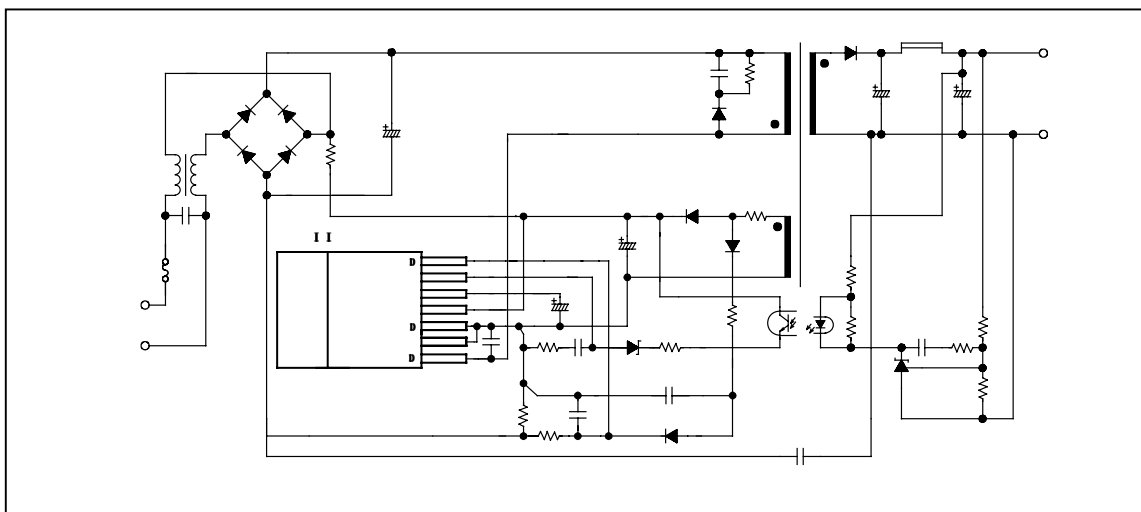

Note 1:

The Pout (W) represents the thermal rating at Quasi-Resonant operation, and the peak power output is obtained by approximating 120 to 140 % of the above listed value. When the output voltage is low, and the ON-duty is narrow, the Pout (W) shall become lower than that of the above.

Absolute Maximum Ratings

Absolute maximum ratings indicate sustained limits beyond which damage to the device may occur. All voltage parameters are absolute voltages referenced to terminals stated, all currents are defined positive into any lead. The thermal resistance and power dissipation ratings are measured under board mounted and still air conditions.

Symbol	Definition	Terminals	Max. Ratings	Units	Note
IDpeak	Drain Current * 1	1 - 3	18	A	Single Pulse
IDMAX	Maximum switching current *2	1 - 3	18	A	Ta=-20~+125
EAS	Single pulse avalanche energy *3	1 - 3	326	mJ	Single Pulse
					VDD=30V,L=50mH
					IL=3.53A
VCC	Input voltage for control part	4 - 3	35	V	
VSSOLP	SS/OLP pin voltage	5 - 3	-0.5 ~ 6.0	V	
IFB	FB pin inflow current	6- 3	10	mA	
VFB	FB pin voltage	6- 3	-0.5 ~ 9.0	V	within the limits of IFB
VOCFBD	O.C.P/F.B pin voltage	7- 3	-1.5 ~ 5.0	V	
PD1	Power dissipation of MOSFET *4	1 - 3	44	W	With infinite heatsink
			2.8		Without heatsink
PD2	Power dissipation for control part (MIC) *5	4 - 3	0.8	W	Specified by Vcc x Icc
TF	Internal frame temperature in operation	-	-20 ~ +125		Refer to recommended operating temperature
Top	Operating ambient temperature	-	-20 ~ +125		
Tstg	Storage temperature	-	-40 ~ +125		
Tch	Channel temperature	-	150		

*1 Refer to MOS FET A.S.O. curve

*2 Maximum switching current

The maximum switching current is the Drain current determined by the drive voltage of the IC and threshold voltage (Vth) of the MOS FET.

*3 Refer to MOS FET Tch-EAS curve

*4 Refer to MOS FET Ta-PD1 curve

Electrical Characteristics (for Control IC)

Electrical characteristics for control part (Ta=25 , Vin=20V,unless otherwise specified)

Symbol	Definition	Terminals	Ratings			Units	Note
			MIN	TYP	MAX		
Power Supply Start-up Operation							
V _{CC(ON)}	Operation Start Voltage	4 - 3	16.3	18.2	19.9	V	V _{cc} =0 20V
V _{CC(OFF)}	Operation Stop Voltage	4 - 3	8.8	9.7	10.6	V	V _{cc} =20 8.8V
I _{CC(ON)}	Circuit Current in Operation	4 - 3	-	-	6	mA	-
I _{CC(OFF)}	Circuit Current in Non-Operation	4 - 3	-	-	100	μA	V _{cc} =15V
fosc	Oscillation Frequency	1 - 2	19	22	25	kHz	-
V _{SSOLP(SS)}	Soft Start Operation Stop Voltage	5 - 3	1.1	1.2	1.4	V	-
I _{SSOLP(SS)}	Soft Start Operation Charging Current	5 - 3	-710	-550	-390	μA	-

Normal Operation							
V _{OCPBD(BS1)}	Bottom-Skip Operation Threshold Voltage1	7 - 3	-0.72	-0.665	-0.605	V	-
V _{OCPBD(BS2)}	Bottom-Skip Operation Threshold Voltage2	7 - 3	-0.485	-0.435	-0.385	V	-
V _{OCPBD(LIM)}	Overcurrent Detection Threshold Voltage	7 - 3	-0.995	-0.94	-0.895	V	-
I _{OCPBD}	OCP/BD Pin Outflow Current	7 - 3	-250	-100	-40	μA	-
V _{OCPBD(TH1)}	Quasi-Resonant Operation Threshold Voltage 1	7 - 3	0.28	0.4	0.52	V	-
V _{OCPBD(TH2)}	Quasi-Resonant Operation Threshold Voltage 2	7 - 3	0.67	0.8	0.93	V	-
V _{FB(OFF)}	FB Pin Threshold Voltage	6 - 3	1.32	1.45	1.58	V	-
I _{FB(ON)}	FB Pin Inflow Current (Normal Operation)	6 - 3	600	1000	1400	μA	-

IRIS-X6757

Electrical Characteristics (for Control IC), Contd.

Stand-by Operation							
$V_{CC(S)}$	Stand-by Operation Start Voltage	4 - 3	10.3	11.1	12.1	V	$V_{CC}=0 \rightarrow 15V$
$V_{CC(SK)}$	Stand-by Operation Start Voltage Interval	4 - 3	1.1	1.35	1.65	V	-
$I_{CC(S)}$	Stand-by Non-Operation Circuit Current	4 - 3	-	20	56	μA	$V_{CC}=10.2V$
$I_{FB(S)}$	FB Pin Inflow Current (Stand-by)	6 - 3	-	4	14	μA	$V_{CC}=10.2V$
$V_{FB(S)}$	Stand-by Operation FB Pin Threshold Voltage	6 - 3	0.55	1.1	1.5	V	$V_{CC}=15V$
$T_{ON(MIN)}$	Minimum ON Time	1 - 2	0.65	1	1.35	μSec	-
Protection Operation							
$T_{ON(MAX)}$	Maximum ON Time	1 - 3	27.5	32.5	39	μSec	-
$V_{SSOLP(OLP)}$	OLP Operation Threshold Voltage	5 - 3	4	4.9	5.8	V	-
$I_{SSOLP(OLP)}$	OLP Operation Charging Current	5 - 3	-16	-11	-6	μA	-
$V_{CC(OVP)}$	OVP Operation Voltage	4 - 3	25.5	27.7	29.9	V	$V_{CC}=0 \rightarrow 30V$
$I_{CC(H)}$	Latch Circuit Holding Current *5	4 - 3	--	45	140	μA	$V_{CC}=30 \rightarrow V_{CC(OFF)}-0.3V$
VCC(La.OFF)	Latch Circuit Release Voltage *5	4 - 3	6	7.2	8.5	V	$V_{CC}=30 \rightarrow 6V$

*5 The latch circuit means a circuit operated O.V.P and O.L.P.

*6 The current ratings are based on those of the IC , and plus(+) represents sink and minus(-) represents source.

Electrical characteristics for MOSFET (Ta=25 deg C)

Symbol	Definition	Terminals	Ratings			Units	Note
			MIN	TYP	MAX		
V _{DSS}	Drain-to-Source breakdown voltage	1 - 2	650	-	-	V	I _D =300μA
I _{DSS}	Drain leakage current	1 - 2	-	-	300	μA	V _{DS} =650V
R _{DS(ON)}	On-resistance	1 - 2	-	-	0.62		I _D =3.4A
t _f	Switching time	1 - 2	-	-	500	nSec	-
ch-F	Thermal resistance	-	-	-	1.09	/W	Between channel and internal frame

IRIS-X6757
A.S.O. temperature derating coefficient curve

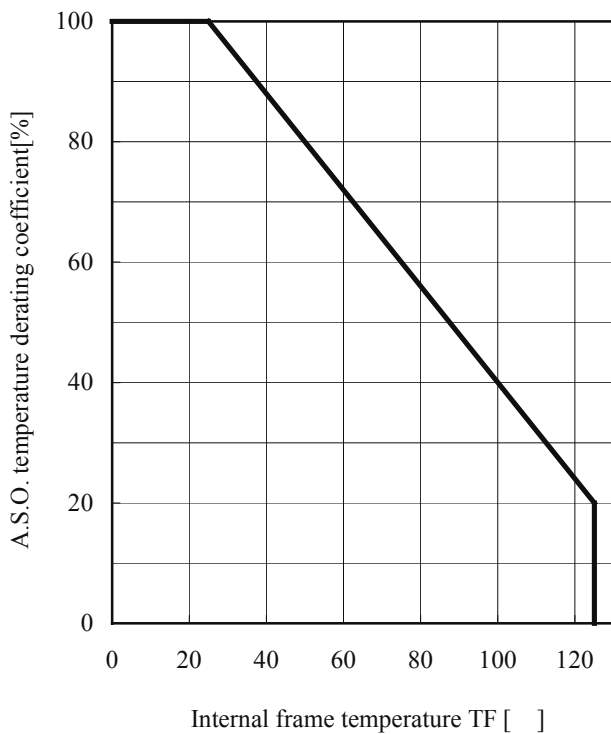

IRIS-X6757
MOSFET A.S.O. Curve

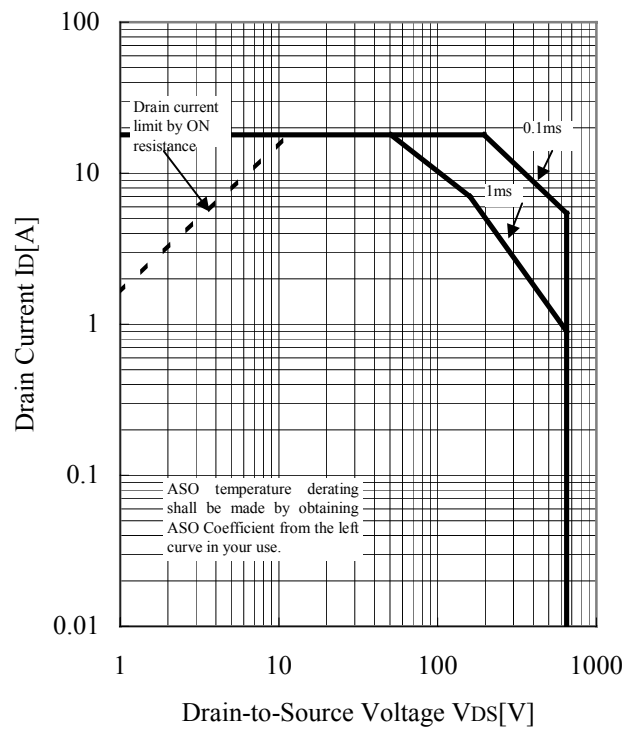

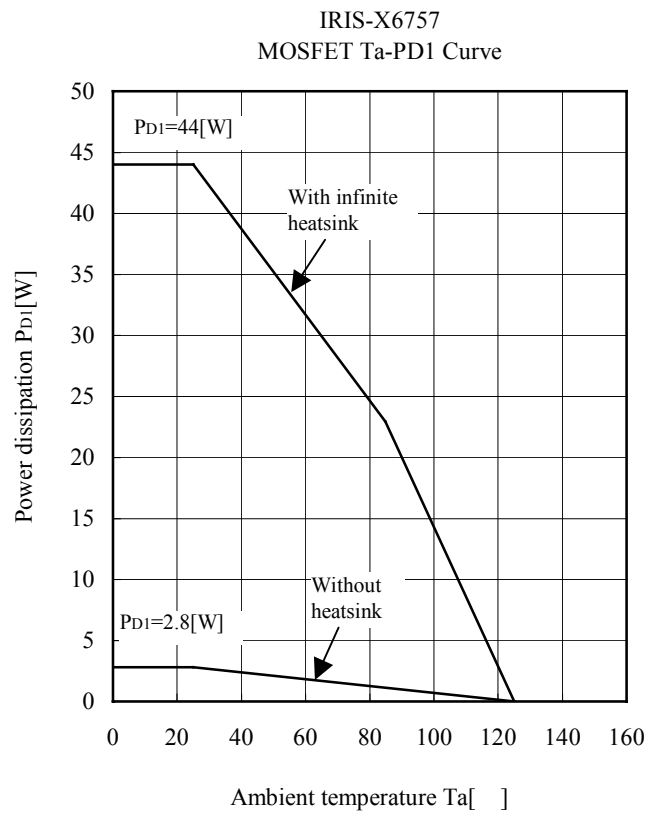
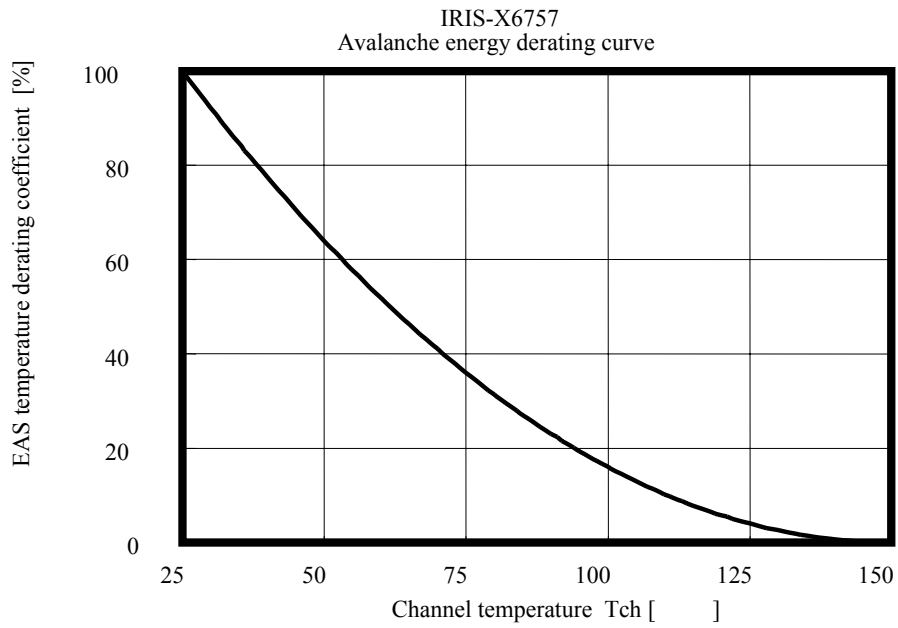

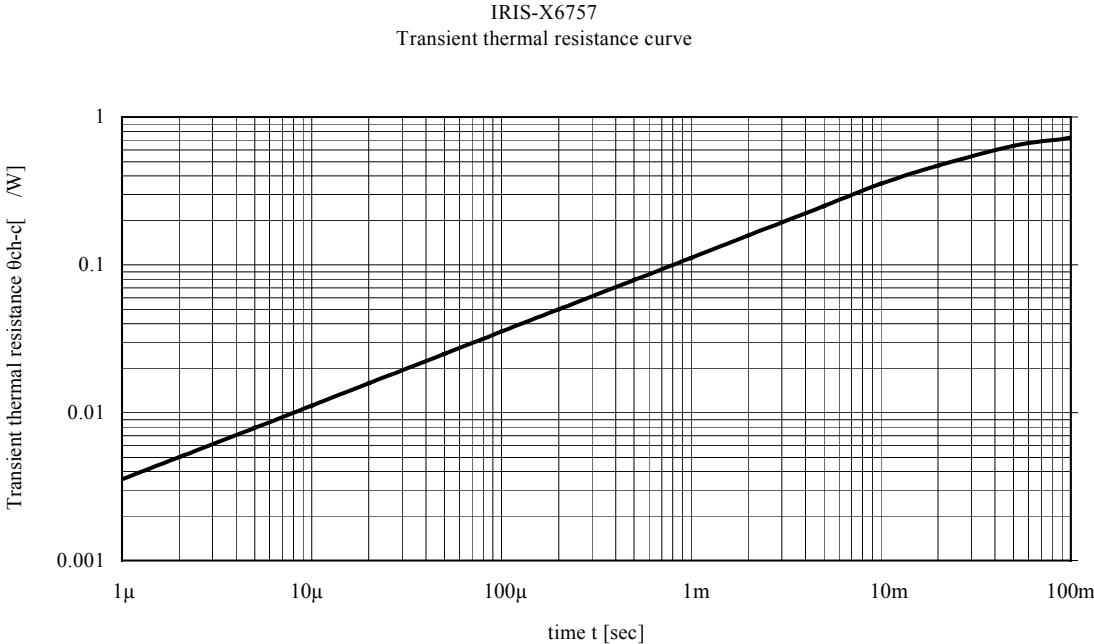
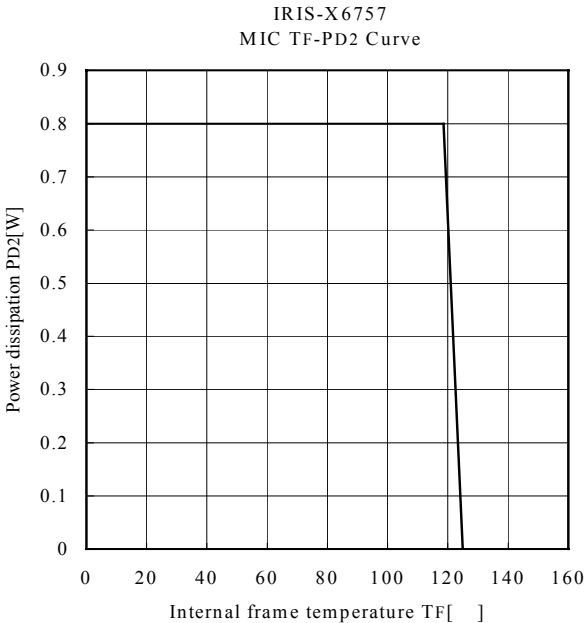

Block Diagram

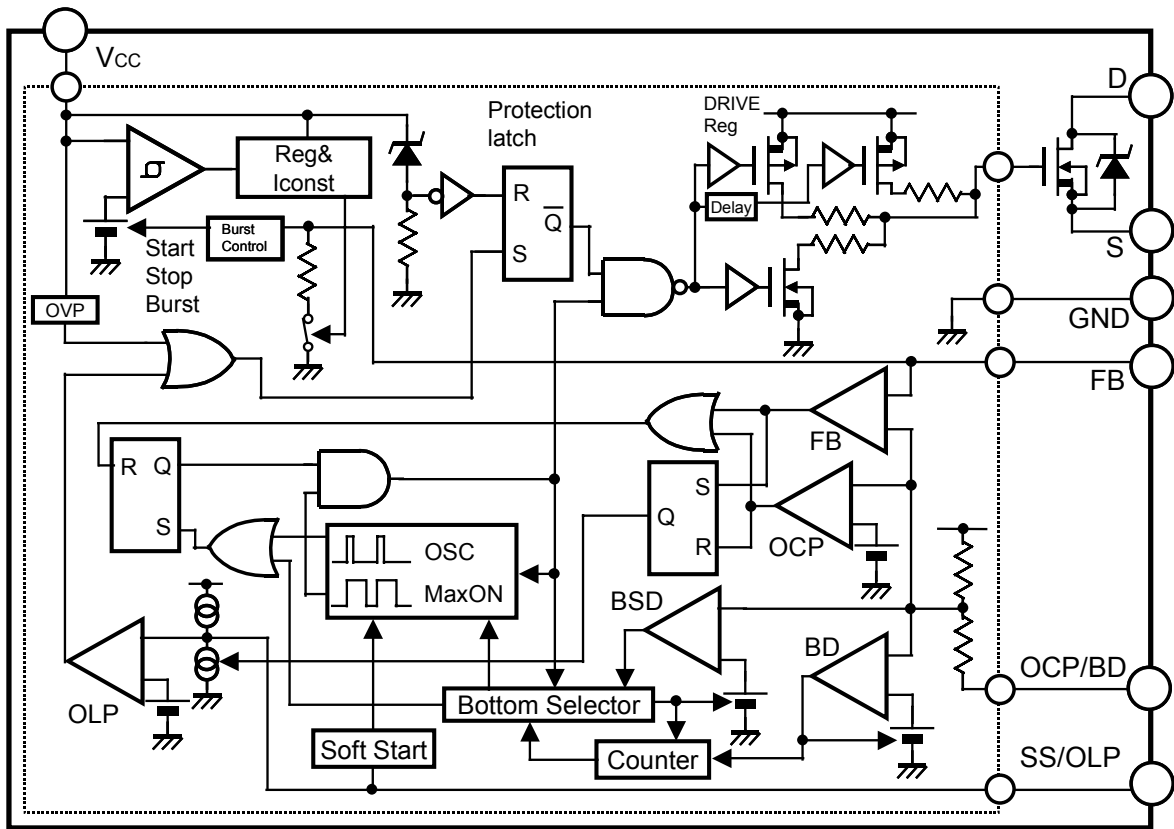

Pin Designation

	Pin No.	Symbols	Descriptions	Functions
	1	D	Drain pin	MOSFET drain
	3	S/GND	Source /Ground pin	MOSFET Source / Ground
	4	Vcc	Power supply pin	Input of power supply for control circuit
	5	SS/OLP	Delay at Overload /Soft Start set up Pin	Overload Protection and Soft Start Operation Time set up
	6	FB	Feedback pin	Constant Voltage Control Signal Input, Burst(intermittent) mode Oscillation Control
	7	OCP/BD	Overcurrent Protection Input / Bottom Detection Pin	Overcurrent Detection Signal Input /Bottom Detection Signal Input

