

## Version 2.0

### Features

- High operating temperature
- High output voltage
- Robust cylindrical housing
- Biasing magnet build in
- Signal amplitude independent of speed
- Easily connectable

### Typical applications

- Detection of speed
- Detection of position
- Detection of sense of rotation
- Angle encoder
- Linear position sensing

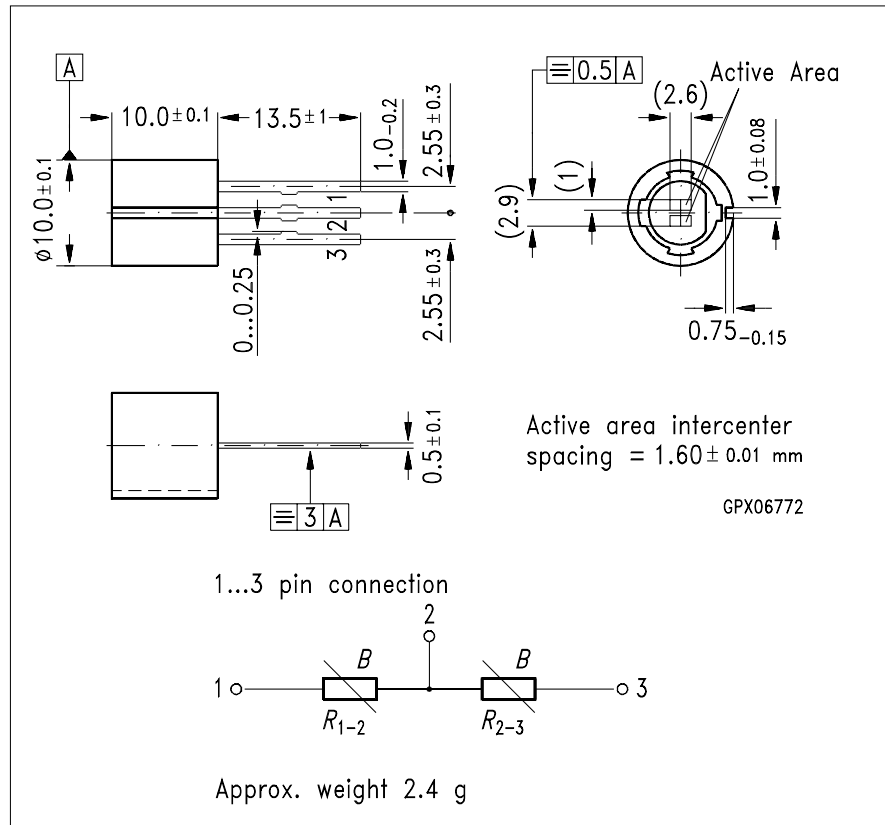

Dimensions in mm

Type	Ordering Code
FP 210 L 100-22	Q65210-L100-W4

The differential magneto-resistive sensor FP 210 L 100-22 consists of two series coupled L-type InSb/NiSb semiconductor resistors. The resistance value of the MRs, which are mounted onto an insulated ferrite substrate, can be magnetically controlled. The sensor is encapsulated in a plastic package with three in-line contacts extending from the base. The basic resistance of the total system in the unbiased state is  $2 \times 100 \Omega$ . A permanent magnet which supplies a biasing magnetic field is built into the housing.

## Absolute Maximum Ratings

Parameter	Symbol	Limit Values	Unit
Operating temperature	$T_A$	- 40/ +140	°C
Storage temperature	$T_{stg}$	- 40/ +150	°C
Power dissipation <sup>1)</sup>	$P_{tot}$	400	mW
Supply voltage <sup>2)</sup>	$V_{IN}$	7.5	V
Insulation voltage between terminals and casing	$V_I$	> 100	V
Thermal conductivity	$G_{thA}$	≥ 5	mW/K

## Electrical Characteristics ( $T_A = 25\text{ °C}$ )

Nominal supply voltage	$V_{IN,N}$	5	V
Total resistance, ( $\delta = \infty$ , $I \leq 1\text{ mA}$ )	$R_{1-3}$	220...400	$\Omega$
Center symmetry <sup>3)</sup> ( $\delta = \infty$ )	$M$	≤ 10	%
Offset voltage <sup>4)</sup> (at $V_{IN,N}$ and $\delta = \infty$ )	$V_0$	≤ 130	mV
Open circuit output voltage <sup>5)</sup> ( $V_{IN,N}$ and $\delta = 0.2\text{ mm}$ )	$V_{out,pp}$	> 1000	mV
Cut-off frequency	$f_c$	> 20	kHz

## Measuring Arrangements

By approaching a soft iron part close to the sensor a change in its resistance is obtained. The potential divider circuit of the magneto resistor causes a reduction in the temperature dependence of the output voltage  $V_{OUT}$ .

1) Corresponding to diagram  $P_{tot} = f(T_A)$

2) Corresponding to diagram  $V_{IN} = f(T_A)$

3) 
$$M = \frac{R_{1-2} - R_{2-3}}{R_{1-2}} \times 100\% \text{ for } R_{1-2} > R_{2-3}$$

4) Corresponding to measuring circuit in **Fig. 2**

5) Corresponding to measuring circuit in **Fig. 2** and arrangement as shown in **Fig. 1**

### 1. Digital Revolution Counting

For digital revolution counting, the sensor should be actuated by a magnetically soft iron toothed wheel. The tooth spacing should correspond to about twice the magneto resistor intercenter spacing (see **Figure 1**).

The two resistors of the sensor are supplemented by two additional resistors in order to obtain the sensor output voltage as a bridge voltage  $V_{OUT}$ . The output voltage  $V_{OUT}$  without excitation then is 0 V when the offset is compensated.

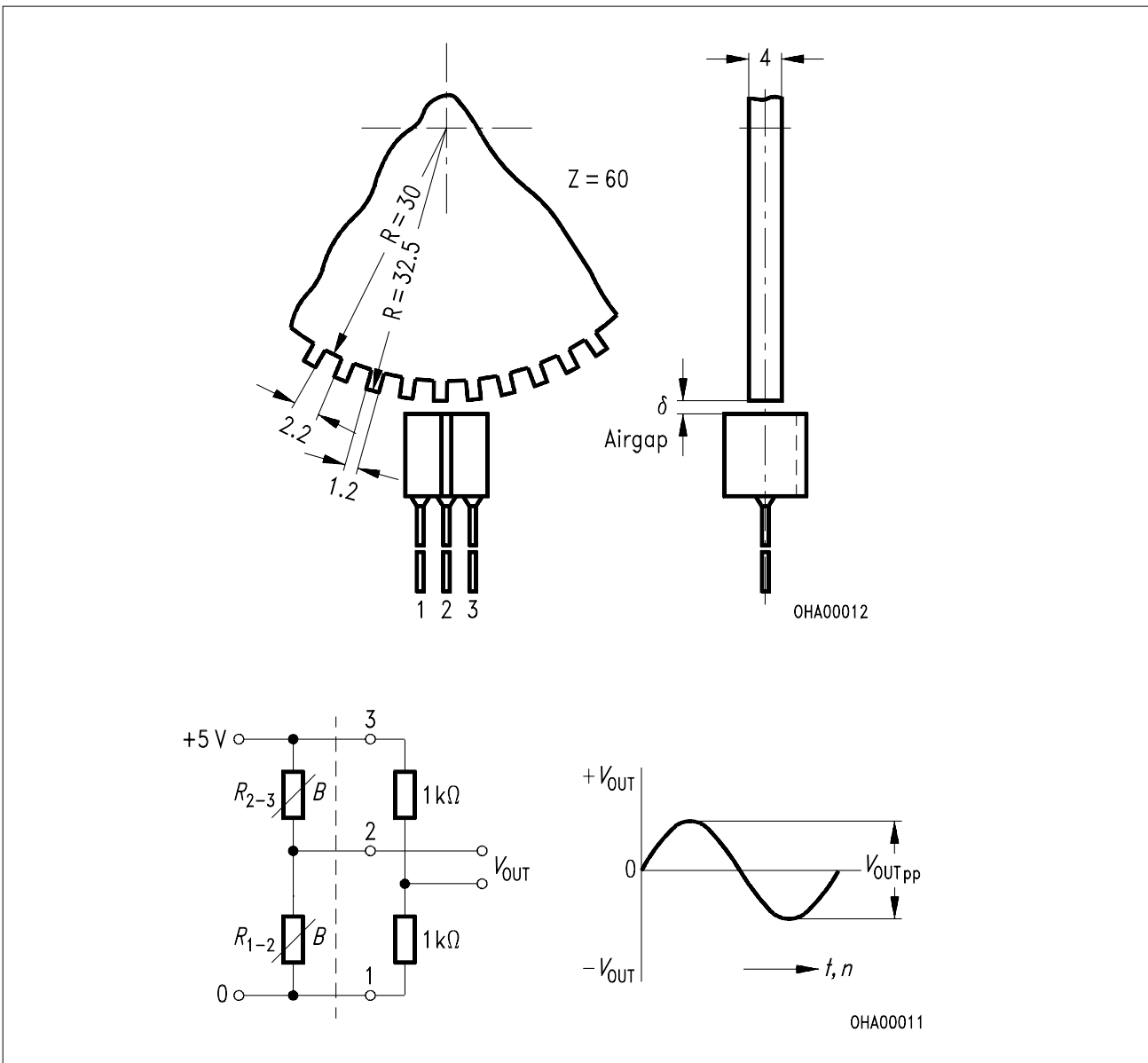

**Figure 1**  
**Schematic Representation of a Toothed Wheel actuating an FP 210 L 100-22**

**Figure 2**  
**Measuring Circuit and Output Voltage  $V_{out}$  Waveform**

## 2. Linear Distance Measurement

To convert small distances into a proportional electric signal, a small soft iron part of definite width (e.g.  $b = 1.8 \text{ mm}$ ) is moved over the face of the sensor.

Proportional signals for distances up to 1.5 mm can be obtained in this way. The sinusoidal output signal gives a voltage proportional to distance in the zero crossover region (see **Figure 3**).

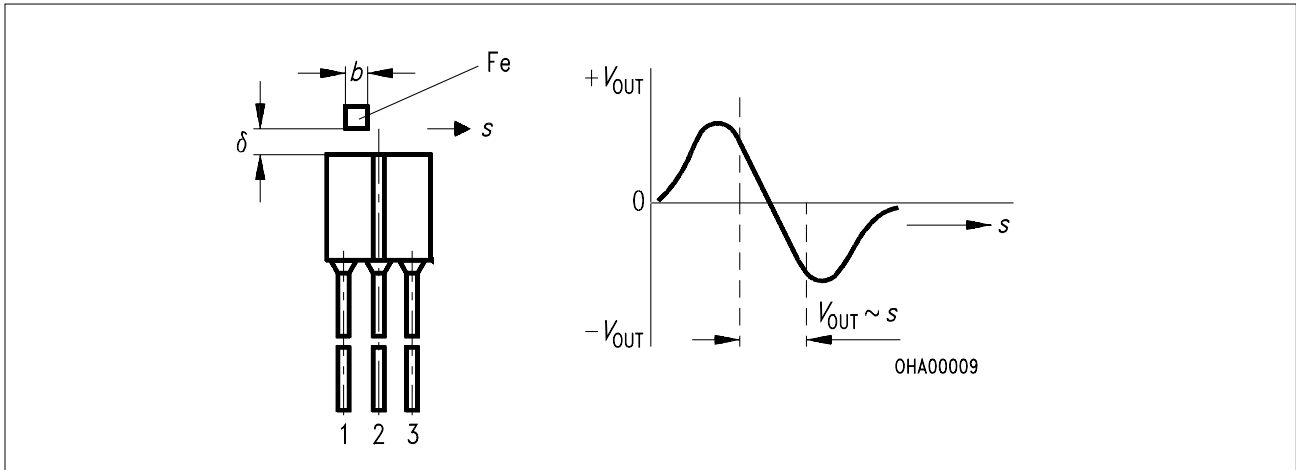

**Figure 3**  
**Arrangement for Analogue Application**

### Maximum supply voltage versus temperature

$$V_{IN} = f(T_A), \delta = \infty$$

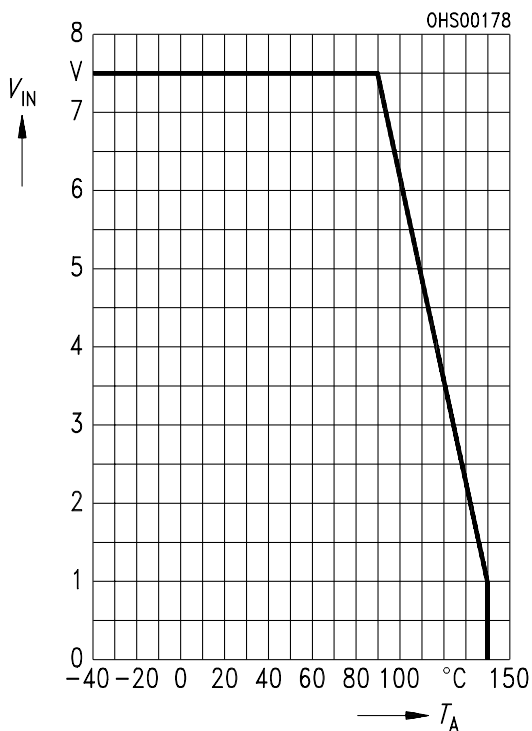

**Output voltage (typical) versus temperature**  $V_{OUTpp} = f(T_A)$ ,  $\delta = 0.2 \text{ mm}$   
 $V_{OUTpp}$  at  $T_A = 25 \text{ }^\circ\text{C} \hat{=} 100\%$

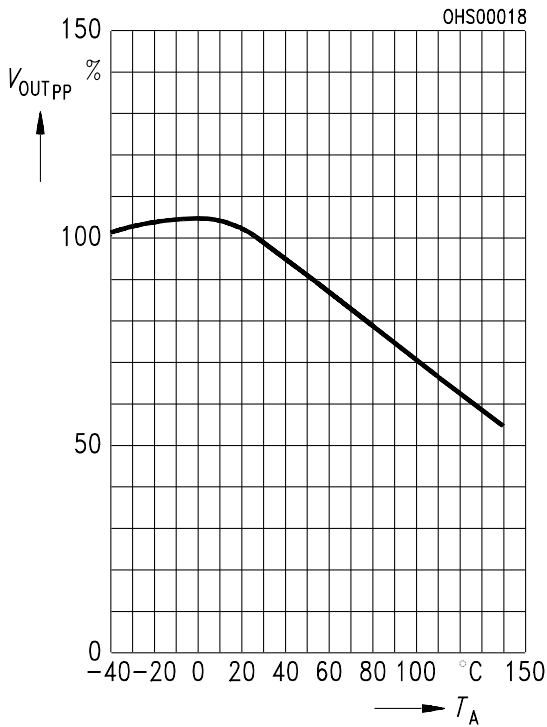

**Output voltage (typical) versus airgap**  $V_{OUTpp} = f(\delta)$ ,  $T_A = 25 \text{ }^\circ\text{C}$   
 $V_{OUTpp}$  at  $\delta = 0.2 \text{ mm} \hat{=} 100\%$

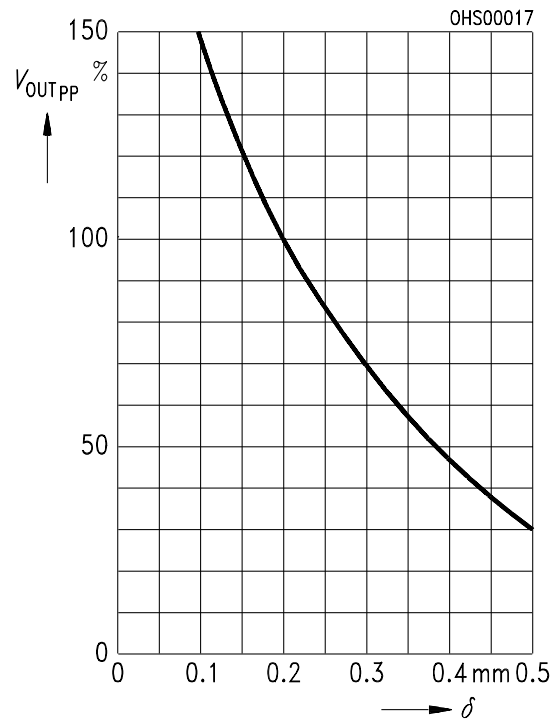

**Total resistance (typical) versus temperature**  
 $R_{1-3} = f(T_A)$ ,  $\delta = \infty$

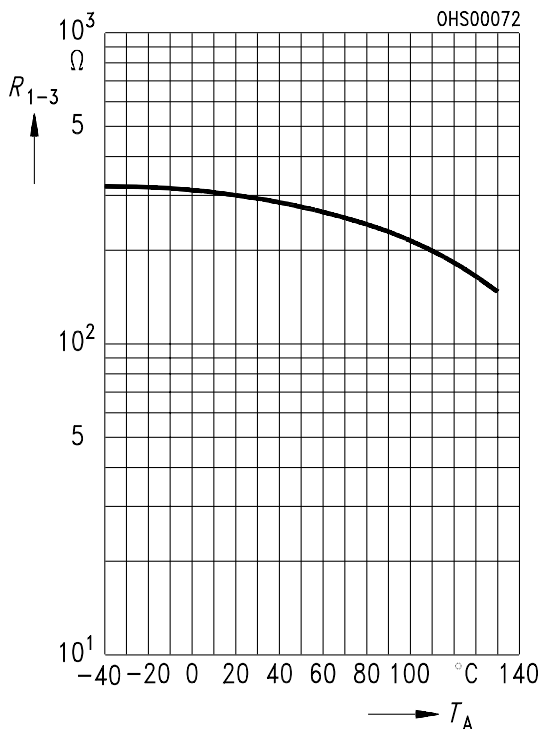

**Max. power dissipation versus temperature**  
 $P_{tot} = f(T_A)$ ,  $\delta = \infty$

