

CRYSTAL OSCILLATOR (Programmable) SPREAD SPECTRUM OUTPUT: CMOS

SG-9101 series

- Frequency range : 0.67 MHz to 170 MHz (1 ppm Step)
- Supply voltage : 1.62 V to 3.63 V
- Function : Output enable (OE) or Standby (\overline{ST})
- Down or Center spread modulation
- Configurable spreading
 - 3 modulation profile (Hershey-kiss, Sine-wave, Triangle),
 - 4 modulation frequency, 6 spread percentage
- Package : 2.5 x 2.0, 3.2 x 2.5, 5.0 x 3.2, 7.0 x 5.0 (mm)
- PLL technology to enable short lead time
- Available field oscillator programmer "SG-Writer II"



Product Number (please contact us)
 SG-9101CA: X1G005301xxxx00
 SG-9101CB: X1G005311xxxx00
 SG-9101CE: X1G005321xxxx00
 SG-9101CG: X1G005291xxxx00

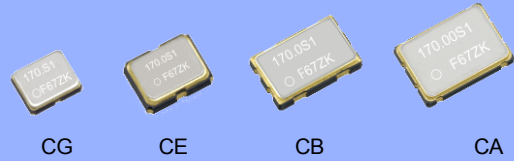

Specifications (characteristics)

Item	Symbol	Specifications				Conditions/Remarks																																														
Supply voltage	V _{CC}	1.80 V Typ.		2.50 V Typ.	3.30 V Typ.	-																																														
		1.62 V to 1.98 V	1.98 V to 2.20 V	2.20 V to 2.80 V	2.70 V to 3.63 V																																															
Output frequency range	f _o	0.67 MHz to 170 MHz																																																		
Storage temperature	T _{stg}	-40 °C to +125 °C				Storage as single product.																																														
Operating temperature	T _{use}	-40 °C to +85 °C																																																		
		-40 °C to +105 °C																																																		
Frequency tolerance ^{*1}	f _{tol}	±50 × 10 ⁻⁶				Average frequency of 1s gate time.																																														
Current consumption	I _{CC}	3.4 mA Max.	3.5 mA Max.	3.6 mA Max.	3.7 mA Max.	T _{use} = +105 °C	No load, f _o = 20 MHz																																													
		2.9 mA Typ.		3.0 mA Typ.	3.2 mA Typ.	T _{use} = +25 °C																																														
		5.7 mA Max.	6.0 mA Max.	6.9 mA Max.	8.3 mA Max.	T _{use} = +105 °C	No load, f _o = 170 MHz																																													
		4.9 mA Typ.		5.9 mA Typ.	7.0 mA Typ.	T _{use} = +25 °C																																														
Output disable current	I _{dis}	3.4 mA Max.	3.4 mA Max.	3.5 mA Max.	3.7 mA Max.	OE = GND, f _o = 170 MHz																																														
Standby current	I _{std}	0.9 µA Max.	1.0 µA Max.	1.5 µA Max.	2.5 µA Max.	T _{use} = +105 °C	\overline{ST} = GND																																													
		0.3 µA Typ.	0.4 µA Typ.	0.5 µA Typ.	1.1 µA Typ.	T _{use} = +25 °C																																														
Symmetry	SYM	45 % to 55 %				50 % V _{CC} Level																																														
Output voltage (DC characteristics)	V _{OH}	90 % V _{CC} Min.				<table border="1"> <thead> <tr> <th colspan="2">I_{OH}/I_{OL} Conditions</th> <th colspan="4">[mA]</th> </tr> <tr> <th>Rise/Fall time</th> <th>V_{CC}</th> <th>*A</th> <th>*B</th> <th>*C</th> <th>*D</th> </tr> </thead> <tbody> <tr> <td rowspan="2">Default (f_o > 40 MHz), Fast</td> <td>I_{OH}</td> <td>-2.5</td> <td>-3.5</td> <td>-4.0</td> <td>-5.0</td> </tr> <tr> <td>I_{OL}</td> <td>2.5</td> <td>3.5</td> <td>4.0</td> <td>5.0</td> </tr> <tr> <td rowspan="2">Default (f_o ≤ 40 MHz)</td> <td>I_{OH}</td> <td>-1.5</td> <td>-2.0</td> <td>-2.5</td> <td>-3.0</td> </tr> <tr> <td>I_{OL}</td> <td>1.5</td> <td>2.0</td> <td>2.5</td> <td>3.0</td> </tr> <tr> <td rowspan="2">Slow</td> <td>I_{OH}</td> <td>-1.0</td> <td>-1.5</td> <td>-2.0</td> <td>-2.5</td> </tr> <tr> <td>I_{OL}</td> <td>1.0</td> <td>1.5</td> <td>2.0</td> <td>2.5</td> </tr> </tbody> </table>		I _{OH} /I _{OL} Conditions		[mA]				Rise/Fall time	V _{CC}	*A	*B	*C	*D	Default (f _o > 40 MHz), Fast	I _{OH}	-2.5	-3.5	-4.0	-5.0	I _{OL}	2.5	3.5	4.0	5.0	Default (f _o ≤ 40 MHz)	I _{OH}	-1.5	-2.0	-2.5	-3.0	I _{OL}	1.5	2.0	2.5	3.0	Slow	I _{OH}	-1.0	-1.5	-2.0	-2.5	I _{OL}	1.0	1.5	2.0	2.5
	I _{OH} /I _{OL} Conditions		[mA]																																																	
Rise/Fall time	V _{CC}	*A	*B	*C	*D																																															
Default (f _o > 40 MHz), Fast	I _{OH}	-2.5	-3.5	-4.0	-5.0																																															
	I _{OL}	2.5	3.5	4.0	5.0																																															
Default (f _o ≤ 40 MHz)	I _{OH}	-1.5	-2.0	-2.5	-3.0																																															
	I _{OL}	1.5	2.0	2.5	3.0																																															
Slow	I _{OH}	-1.0	-1.5	-2.0	-2.5																																															
	I _{OL}	1.0	1.5	2.0	2.5																																															
V _{OL}	10 % V _{CC} Max.																																																			
Output load condition	L _{CMOS}	15 pF Max.				-																																														
Input voltage	V _{IH}	70 % V _{CC} Min.				OE or \overline{ST}																																														
	V _{IL}	30 % V _{CC} Max.																																																		
Rise and Fall time	Default	tr/ff	3.0 ns Max.		f _o > 40 MHz		20 % - 80 % V _{CC} , L _{CMOS} = 15 pF																																													
			6.0 ns Max.		f _o ≤ 40 MHz																																															
			3.0 ns Max.		f _o = 0.67 MHz to 170 MHz																																															
			10.0 ns Max.		f _o = 0.67 MHz to 20 MHz																																															
Disable Time	t _{stp}	1 µs Max.				Measured from the time OE or \overline{ST} pin crosses 30 % V _{CC}																																														
Enable Time	t _{sta}	1 µs Max.				Measured from the time OE pin crosses 70 % V _{CC}																																														
Resume Time	t _{res}	3 ms Max.				Measured from the time \overline{ST} pin crosses 70 % V _{CC}																																														
Start-up time	t _{str}	3 ms Max.				Measured from the time V _{CC} reaches its rated minimum value, 1.62 V																																														

*1 Frequency tolerance includes initial frequency tolerance, temperature variation, supply voltage variation, reflow drift, load drift and aging (+25 °C, 1 year).

Spread spectrum configuration

④	C: Center spread modulation	ⓐCode	02	05	07	10	15	20
		Spread percentage	±0.25 %	±0.5 %	±0.75 %	±1.0 %	±1.5 %	±2.0 %
④	D: Down spread modulation	ⓐCode	05	10	15	20	30	40
		Spread percentage	-0.5 %	-1.0 %	-1.5 %	-2.0 %	-3.0 %	-4.0 %

Modulation frequency: 25.4 kHz (default), 6.3 kHz, 8.5 kHz, 12.7 kHz

Modulation profile: Hershey-kiss (default), Sine-wave, Triangle

Product Name

SG-9101CG 170.00000MHz C 20 P H A A A

① ② ③ ④ ⑤ ⑥ ⑦ ⑧ ⑨ ⑩

② Package Type
 CA: 7.0 mm x 5.0 mm
 CB: 5.0 mm x 3.2 mm
 CE: 3.2 mm x 2.5 mm
 CG: 2.5 mm x 2.0 mm

④ Spread type
 C: Center spread
 D: Down spread

⑦ Operating temperature
 G: -40 °C to +85 °C
 H: -40 °C to +105 °C

⑨ Modulation profile
 A: Hershey-kiss (default)
 B: Sine-wave
 C: Triangle

- ① Model, ② Package type, ③ Frequency,
 ④ Spread type, ⑤ Spread percentage code,
 ⑥ Function, ⑦ Operating temperature,
 ⑧ Modulation frequency, ⑨ Modulation profile, ⑩ Rise/Fall time

⑥ Function
 P: Output enable
 S: Standby

⑧ Modulation frequency
 A: 25.4 kHz (default)
 B: 12.7 kHz
 C: 8.5 kHz
 D: 6.3 kHz

⑩ Rise/Fall time
 A: Default
 B: Fast
 C: Slow



Pin description

Pin	Name	I/O type	Function
1	OE	Input	Output enable High: Specified frequency output from OUT pin Low: Out pin is low (weak pull down), only output driver is disabled.
	ST	Input	Standby High: Specified frequency output from OUT pin Low: Out pin is low (weak pull down), Device goes to standby mode. Supply current reduces to the least as I _{std} .
2	GND	Power	Ground
3	OUT	Output	Clock output
4	V _{CC}	Power	Power supply

External dimensions

(Unit: mm)

Footprint (Recommended)

(Unit: mm)

SG-9101CG

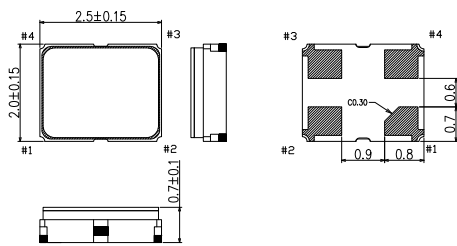

SG-9101CG

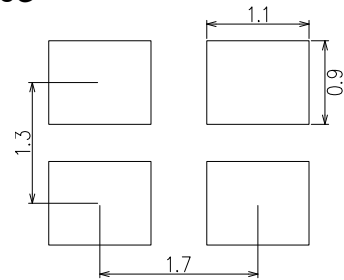

SG-9101CE

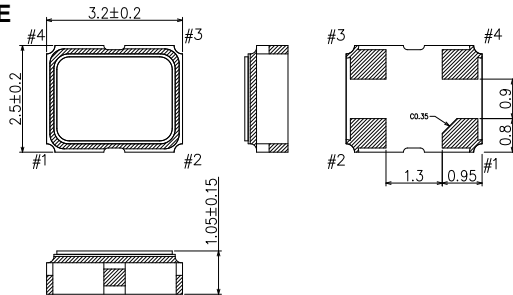

SG-9101CE

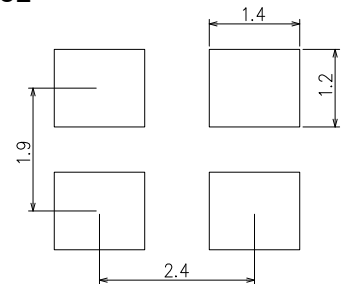

SG-9101CB

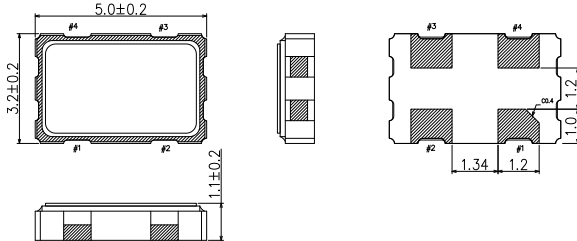

SG-9101CB

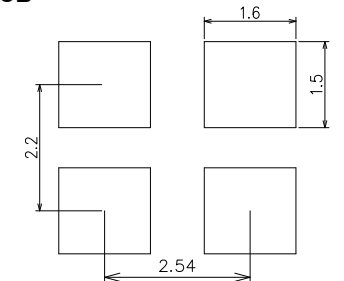

SG-9101CA

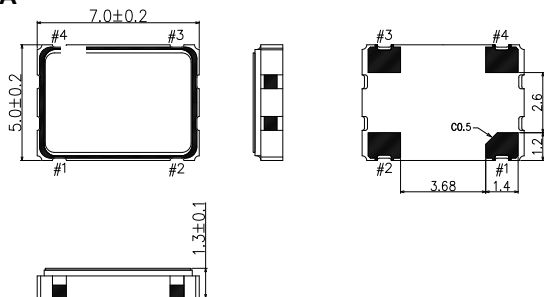

SG-9101CA

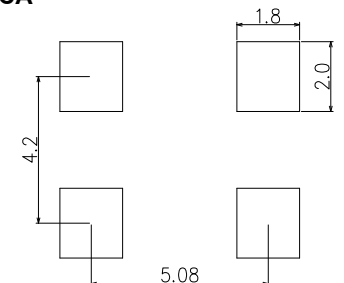

Notes:

In order to achieve optimum jitter performance, the 0.1 μF capacitor between V_{CC} and GND should be placed. It is also recommended that the capacitors are placed on the device side of the PCB, as close to the device as possible and connected together with short wiring pattern.

Specification Graph (Typical supplemental specification. Unless otherwise specified $T_{use} = 25\text{ }^{\circ}\text{C}$, $L_{CMOS} = 15\text{pF}$)

Current Consumption

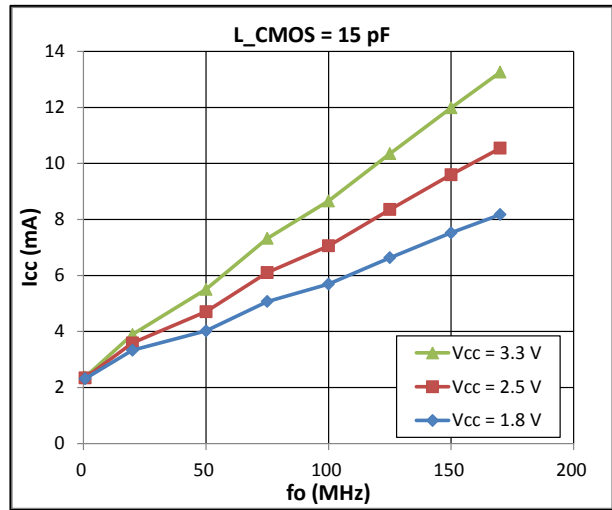
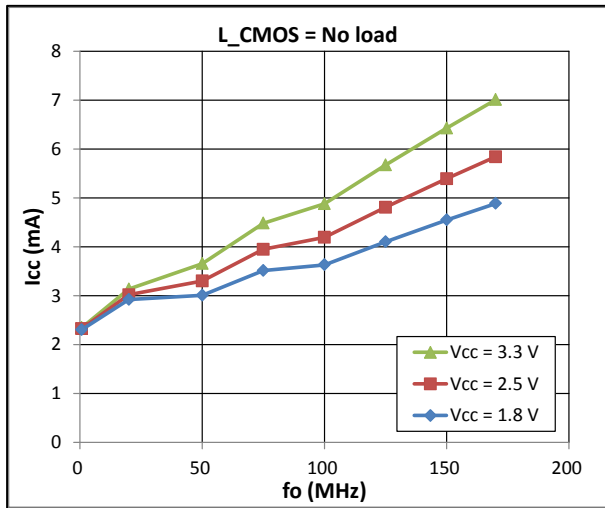

Output disable current

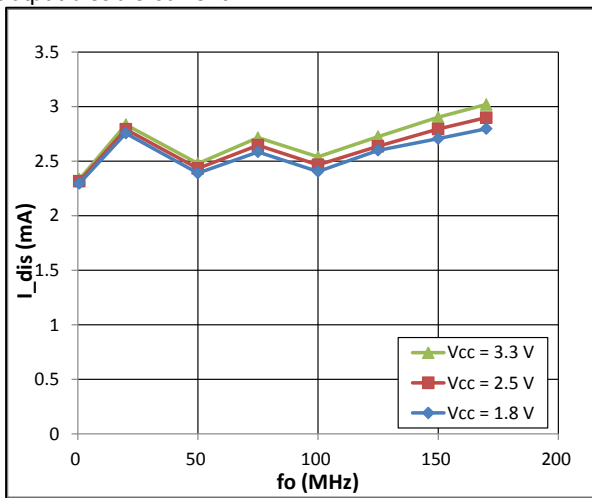

Standby current

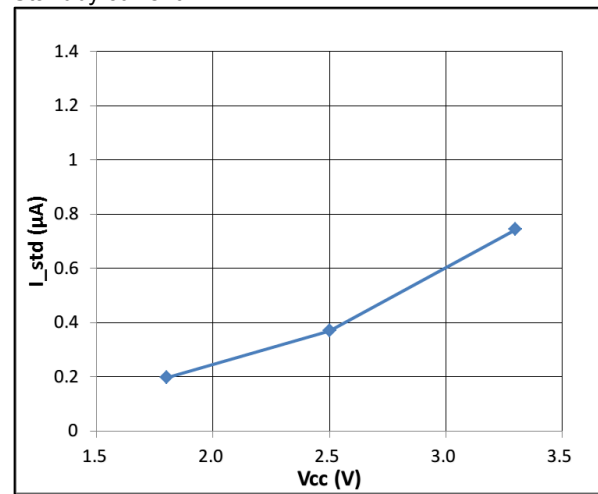

Notes:

Spread percentage : $\pm 2.0\%$, Modulation frequency : 25.4 kHz, Modulation profile : Hershey-kiss

Specification Graph (Typical supplemental specification. Unless otherwise specified $T_{use} = 25\text{ }^{\circ}\text{C}$, $L_{CMOS} = 15\text{pF}$)

Cycle-to-Cycle Jitter Peak-Peak

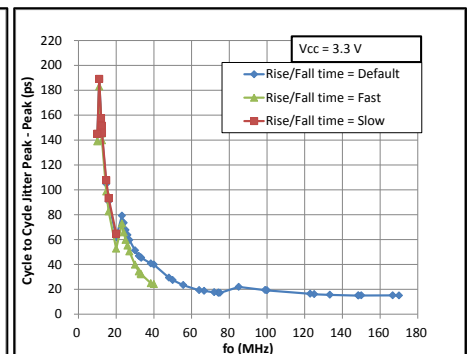
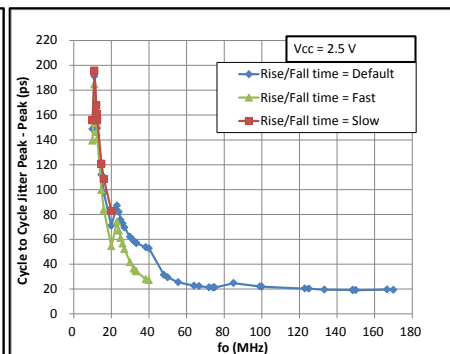
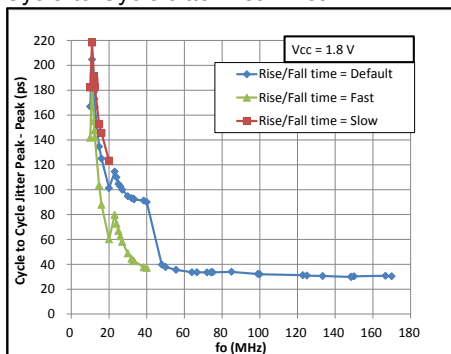

Notes:

Spread percentage : $\pm 2.0\%$, Modulation frequency : 25.4 kHz, Modulation profile : Hershey-kiss



Spread Spectrum Specification Graph

Spread Spectrum Profile fo : 170 MHz / Spread spectrum : ±2.0 % / Modulation frequency : 25.4 kHz

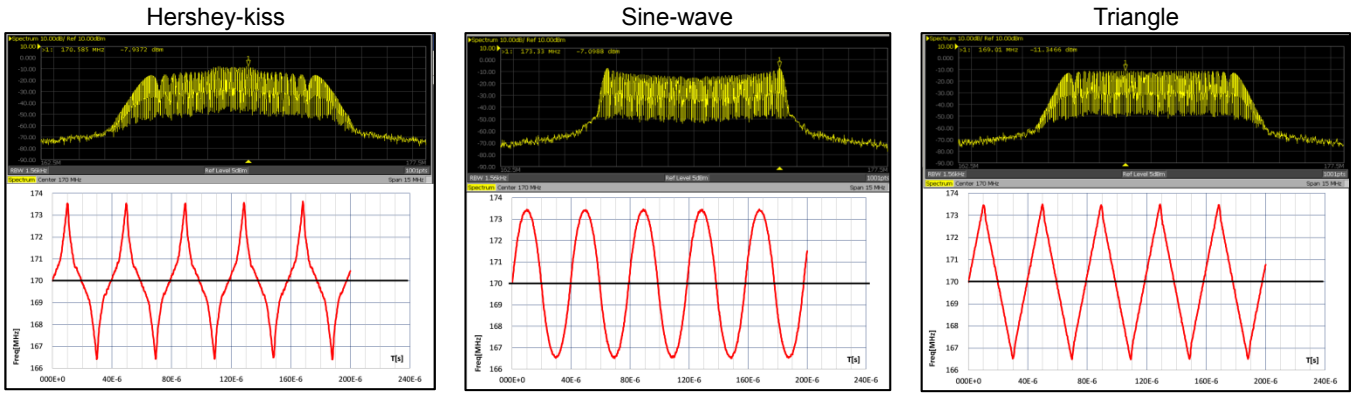

Harmonics Specification Graph (Typical supplemental specification. Unless otherwise specified T_{use} = 25 °C, L_{CMOS} = 15 pF, V_{CC} = 3.3 V)

Harmonics spectrum (fo = 20 MHz) No spread spectrum

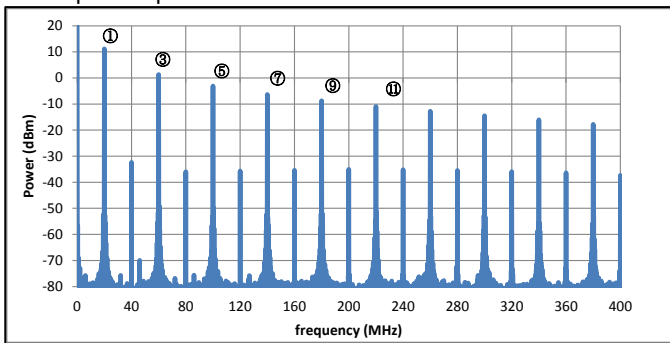

Center spread ±2.0 %, Hershey-kiss, 25.4 kHz

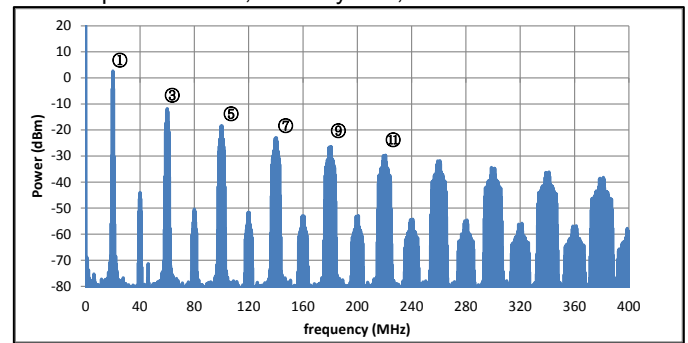

Modulation profile

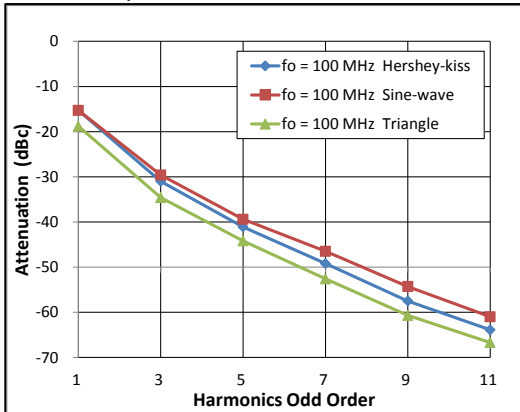

Modulation frequency

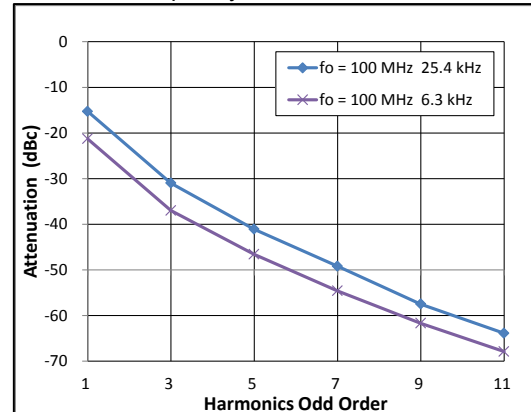

Spread percentage

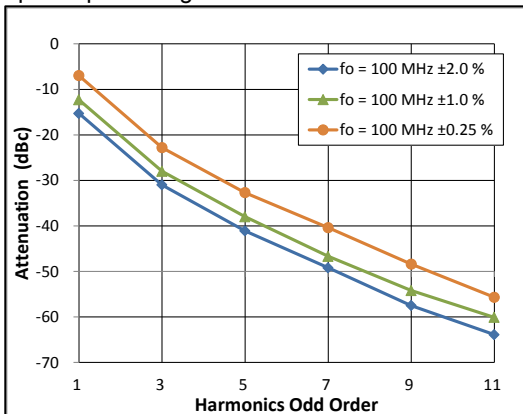

Output frequency

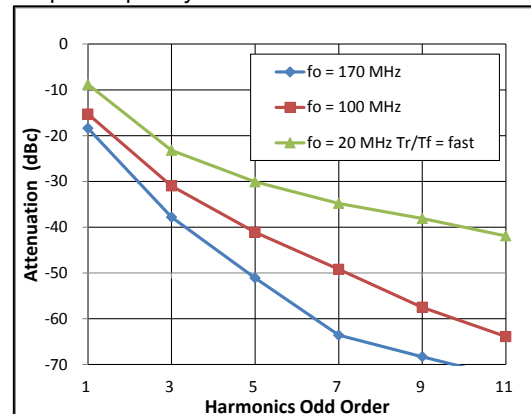

Notes: Harmonics order attenuation is normalizing to no-spread spectrum mode.

Specification Graph

(Typical supplemental specification. Unless otherwise specified $T_{use} = 25\text{ }^{\circ}\text{C}$, $L_{CMOS} = 15\text{ pF}$, $V_{CC} = 3.3\text{ V}$)

Rise/Fall Time ($f_o = 20\text{ MHz}$)

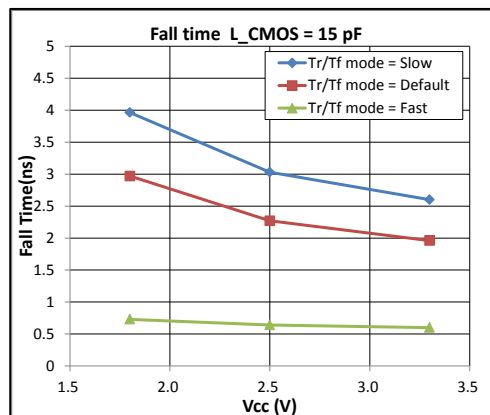
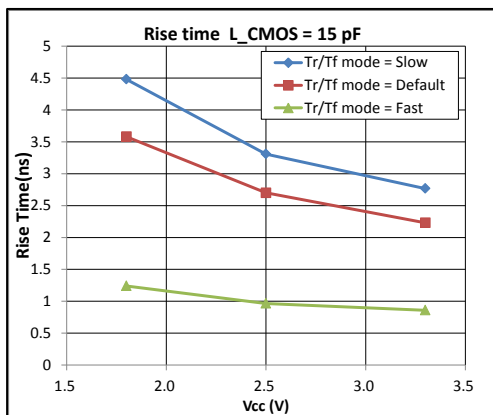
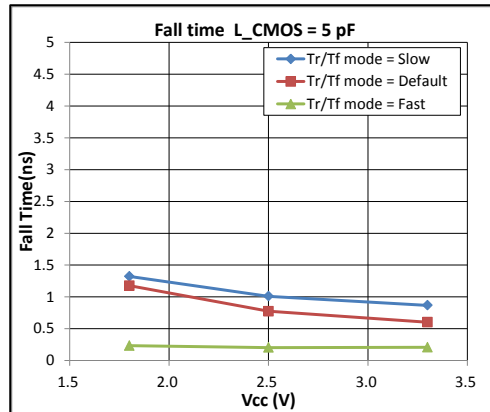
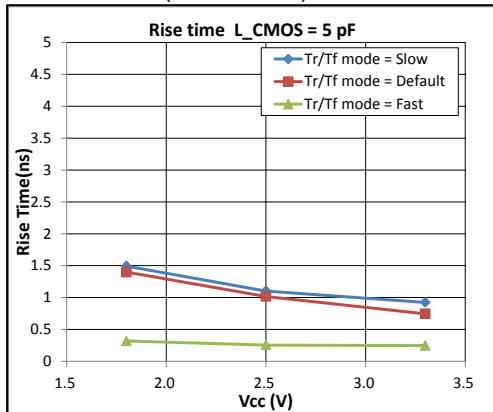

Harmonics comparison

Center spread $\pm 2.0\%$, Hershey-kiss, 25.4 kHz

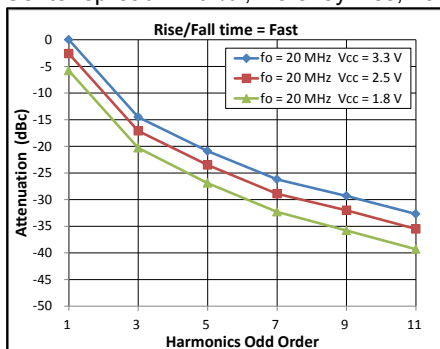

Normalize to $V_{CC} = 3.3\text{ V}$.

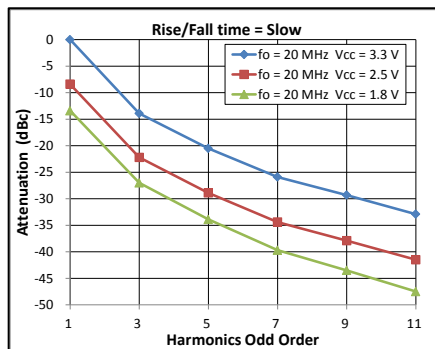

Normalize to $V_{CC} = 3.3\text{ V}$.

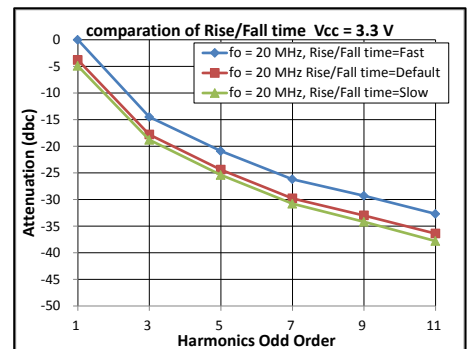

Normalize to Rise/Fall time = "Fast".

Notes:

frequency	slow	default	fast
0.67 M – 20 MHz	See Slow	See Default	See Fast
20 M – 40 MHz	-	See Default	See Fast
40 M – 170 MHz	-	See Fast	See Fast



Simulation Model

- IBIS Model is available upon request. Please contact us.
Information Required: Oscillator operating condition (i.e. Power Supply, Rise/Fall Time, Temperature)

ESD Rating

Test items	Breakdown voltage
Human Body Model (HBM)	2 000 V
Machine Model (MM)	250 V
Charged Device Model (CDM)	750 V

Device Material & Environmental Information

Model	Package Dimensions	# of Pins	Reference Weight (Typ.)	Terminal Material	Terminal Plating	Complies With EU RoHS	Pb Free	MSL Rating	Peak Temp. (Max)
SG-9101CG	2.5x2.0x0.7 mm	4	13 mg	W	Au	Yes	Yes	1	260 °C
SG-9101CE	3.2x2.5x1.0 mm	4	25 mg	W	Au	Yes	Yes	1	260 °C
SG-9101CB	5.0x3.2x1.1 mm	4	51 mg	W	Au	Yes	Yes	1	260 °C
SG-9101CA	7.0x5.0x1.3 mm	4	143 mg	W	Au	Yes	Yes	1	260 °C

SMD products Reflow profile(example)

The availability of the heat resistance for reflow conditions of JEDEC-STD-020D.01 is judged individually. Please inquire.

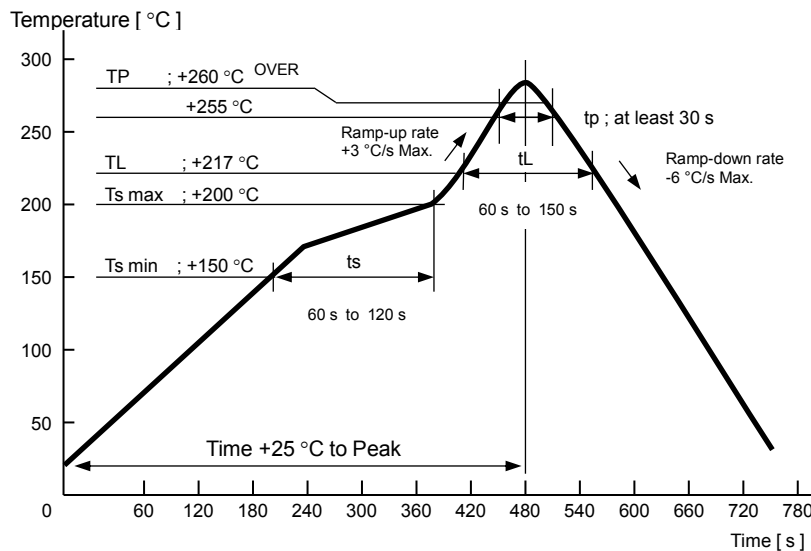

	<ul style="list-style-type: none"> Pb free.
	<ul style="list-style-type: none"> Complies with EU RoHS directive. <ul style="list-style-type: none"> About the products without the Pb-free mark. Contains Pb in products exempted by EU RoHS directive. (Contains Pb in sealing glass, high melting temperature type solder or other.)

Device Marking

Model	Factory Programmed Part Marking	Field Programmable Part Marking (Blank Samples)
SG-9101CG		
SG-9101CE		
SG-9101CB		
SG-9101CA		

Standard Packing Specification

SMD products are packed in the shipping carton as below table in accordance with taping standards EIA-481 and IEC-60286

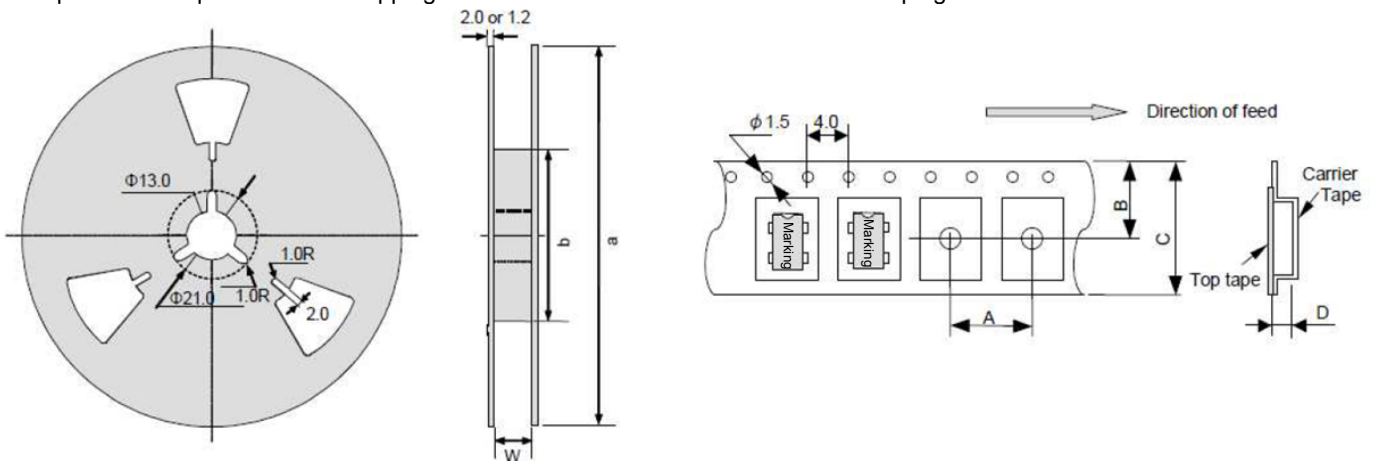

Standard Packing Quantity & Dimension (Unit mm)

Model	Quantity (pcs/Reel)	Reel Dimension			Career Tape Dimension				Direction of Feed (L= Left Direction)
		a	b	W	A	B	C	D	
SG-9101CG	3000	Φ180	Φ60	9	4	5.25	8	1.15	L
SG-9101CE	2000	Φ180	Φ60	9	4	5.25	8	1.4	L
SG-9101CB	1000	Φ180	Φ60	13	8	7.25	12	1.4	L
SG-9101CA	1000	Φ254	Φ100	17.5	8	9.25	16	2.3	L

PROMOTION OF ENVIRONMENTAL MANAGEMENT SYSTEM CONFORMING TO INTERNATIONAL STANDARDS

At Seiko Epson, all environmental initiatives operate under the Plan-Do-Check-Action (PDCA) cycle designed to achieve continuous improvements. The environmental management system (EMS) operates under the ISO 14001 environmental management standard.

All of our major manufacturing and non-manufacturing sites, in Japan and overseas, completed the acquisition of ISO 14001 certification.

ISO 14000 is an international standard for environmental management that was established by the International Standards Organization in 1996 against the background of growing concern regarding global warming, destruction of the ozone layer, and global deforestation.

WORKING FOR HIGH QUALITY

In order provide high quality and reliable products and services than meet customer needs,

Seiko Epson made early efforts towards obtaining ISO9000 series certification and has acquired ISO9001 for all business establishments in Japan and abroad. We have also acquired ISO/TS 16949 certification that is requested strongly by major automotive manufacturers as standard.

ISO/TS16949 is the international standard that added the sector-specific supplemental requirements for automotive industry based on ISO9001.

► Explanation of the mark that are using it for the catalog

	► Pb free.
	► Complies with EU RoHS directive. *About the products without the Pb-free mark. Contains Pb in products exempted by EU RoHS directive. (Contains Pb in sealing glass, high melting temperature type solder or other.)
	► Designed for automotive applications such as Car Multimedia, Body Electronics, Remote Keyless Entry etc.
	► Designed for automotive applications related to driving safety (Engine Control Unit, Air Bag, ESC etc).

Notice

- This material is subject to change without notice.
- Any part of this material may not be reproduced or duplicated in any form or any means without the written permission of Seiko Epson.
- The information about applied data, circuitry, software, usage, etc. written in this material is intended for reference only. Seiko Epson does not assume any liability for the occurrence of customer damage or infringing on any patent or copyright of a third party. This material does not authorize the licensing for any patent or intellectual copyrights.
- When exporting the products or technology described in this material, you should comply with the applicable export control laws and regulations and follow the procedures required by such laws and regulations.
- You are requested not to use the products (and any technical information furnished, if any) for the development and/or manufacture of weapon of mass destruction or for other military purposes. You are also requested that you would not make the products available to any third party who may use the products for such prohibited purposes.
- These products are intended for general use in electronic equipment. When using them in specific applications that require extremely high reliability, such as the applications stated below, you must obtain permission from Seiko Epson in advance.
/ Space equipment (artificial satellites, rockets, etc.) / Transportation vehicles and related (automobiles, aircraft, trains, vessels, etc.) / Medical instruments to sustain life / Submarine transmitters / Power stations and related / Fire work equipment and security equipment / traffic control equipment / and others requiring equivalent reliability.
- All brands or product names mentioned herein are trademarks and/or registered trademarks of their respective.