

VDP Industrial Series Remote Adhesive-Mount Dual-Band WiFi Antenna

The Linx VDP industrial series offers rugged remote-mount dipole antennas having excellent performance for single- and dual-band WiFi/WLAN as well as other 2.4 GHz or 5 GHz ISM and U-NII frequency band applications.

The dual-band VDP industrial antennas are durable, low profile, IP67 ratable, and UV protected. They mount permanently to non-conductive surfaces using the integrated adhesive patch and connect using 2 meters of RG-174/U low-loss cable terminated in an SMA plug (male pin), or RP-SMA plug (female socket) connector for FCC Part 15 compliant applications.



Features

- Performance at 2.4 GHz
 - VSWR: ≤ 1.5
 - Peak Gain: 2.4 dBi
 - Efficiency: 23%
- Performance at 5 GHz
 - VSWR: ≤ 1.4
 - Peak Gain: -0.6 dBi
 - Efficiency: 12%
- Low profile
 - 115.0 mm x 22.0 mm x 6.3 mm
- Durable UV protected enclosure rated at IP67 for heavy-duty outdoor use
- Low-loss RG-174/U coaxial cable for improved performance at higher frequencies
- SMA plug (male pin) or RP-SMA plug (female socket) connector

Applications

- Single- and dual-band WiFi/WLAN
 - 802.11b/g
 - WiFi 4 (802.11n)
 - WiFi 5 (802.11ac)
 - U-NII bands 1-4
- ISM Applications:
 - Bluetooth®
 - ZigBee®
- Internet of Things (IoT) devices
- Smart Home networking
- Sensing and remote monitoring

Ordering Information

Part Number	Description
ANT-2/5-VDP-2000-SMA	Remote adhesive-mount dual-band WiFi antenna with 2 m of RG-174/U low-loss coaxial cable terminated in an SMA plug (male pin)
ANT-2/5-VDP-2000-RPS	Remote adhesive-mount dual-band WiFi antenna with 2 m of RG-174/U low-loss coaxial cable terminated in an RP-SMA plug (female socket)

Available from Linx Technologies and select distributors and representatives.

Table 1. Electrical Specifications

ANT-2/5-VDP-2000	2.4 GHz	5 GHz	
Frequency Range	2.4 GHz to 2.485 GHz	5.15 GHz to 5.85 GHz	
VSWR (max)	1.5	1.4	
Peak Gain (dBi)	2.4	-0.6	
Average Gain (dBi)	-6.6	-10.6	
Efficiency (%)	23	12	
Polarization	Linear	Radiation	Omnidirectional
Impedance	50 Ω	Max Power	10 W
Wavelength	1/2-wave	Electrical Type	Dipole

Table 2. Mechanical Specifications

ANT-2/5-VDP-2000	Dual Band WiFi
Connection	SMA plug (male pin) or RP-SMA plug (female socket)
Cable	2.0 m (78.74 in) of RG-174/U low-loss coaxial cable
Operating Temp. Range	-40 °C to +85 °C
Weight	47.0 g (1.66 oz)
Dimensions	115.0 mm x 22.0 mm x 6.2 mm (4.53 in x 0.87 in x 0.24 in)

Product Dimensions

Figure 1 provides dimensions of the ANT-2/5-VDP-2000. The antenna comes with 2 m (78.74 in) of RG-174/U low-loss coaxial cable terminated by an SMA plug (male pin) or RP-SMA plug (female socket) connector.

Antenna Mounting

The remote adhesive-mount VDP industrial series antenna mounts permanently to non-conductive surfaces using the integrated adhesive patch. The mounting surface should be clean, dry and free of oil residue for ideal adhesion.

Packaging Information

The VDP industrial series antennas are packaged in bags of 50. Distribution channels may offer alternative packaging options.

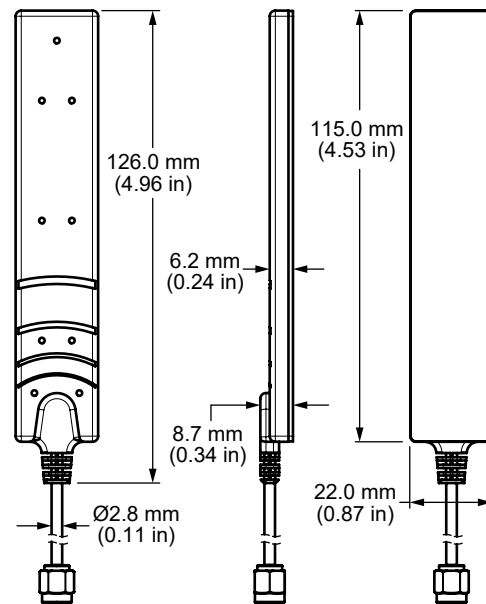

Figure 1. ANT-2/5-VDP-2000 Antenna Dimensions

Datasheet

VSWR

Figure 2 provides the voltage standing wave ratio (VSWR) across the antenna bandwidth. VSWR describes the power reflected from the antenna back to the radio. A lower VSWR value indicates better antenna performance at a given frequency. Reflected power is also shown on the right-side vertical axis as a gauge of the percentage of transmitter power reflected back from the antenna.

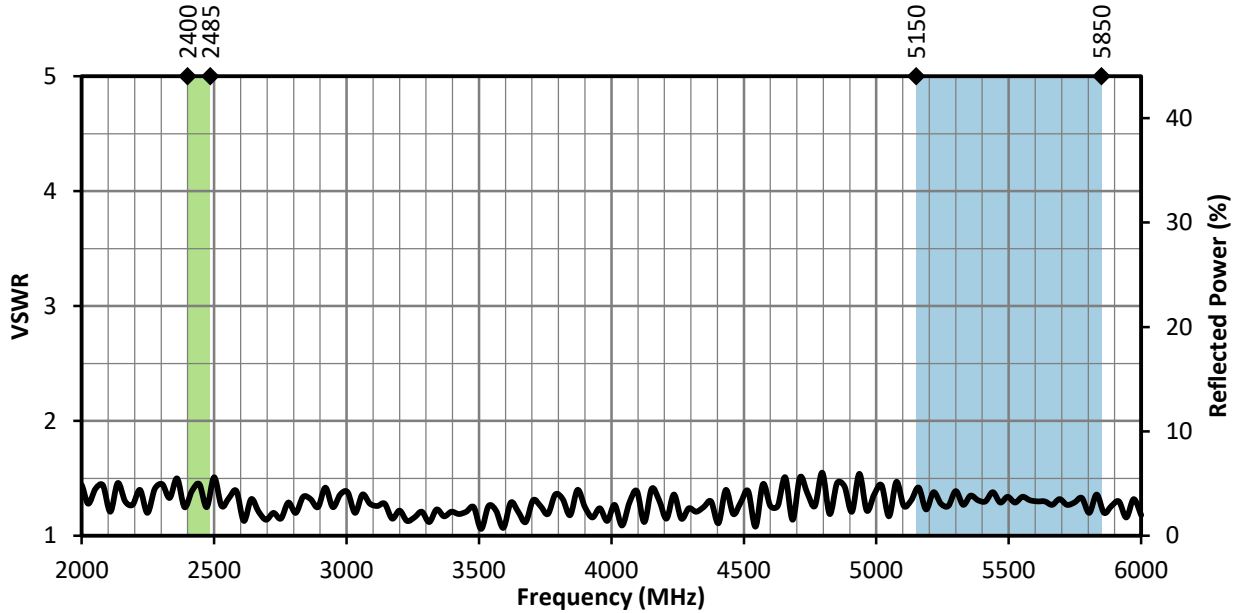

Figure 2. ANT- 2/5-VDP-2000 VSWR with Frequency Band Highlights

Return Loss

Return loss (Figure 3), represents the loss in power at the antenna due to reflected signals. Like VSWR, a lower return loss value indicates better antenna performance at a given frequency.

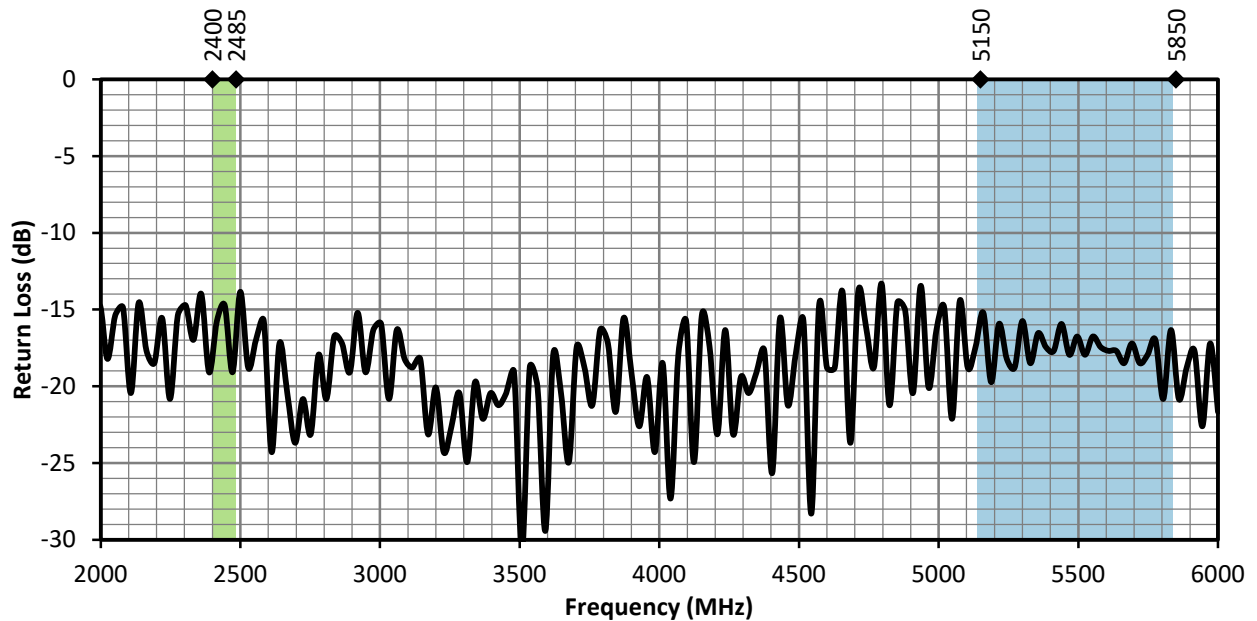

Figure 3. ANT- 2/5-VDP-2000 Return Loss with Frequency Band Highlights

Peak Gain

The peak gain across the antenna bandwidth is shown in Figure 4. Peak gain represents the maximum antenna input power concentration across 3-dimensional space, and therefore peak performance at a given frequency, but does not consider any directionality in the gain pattern.

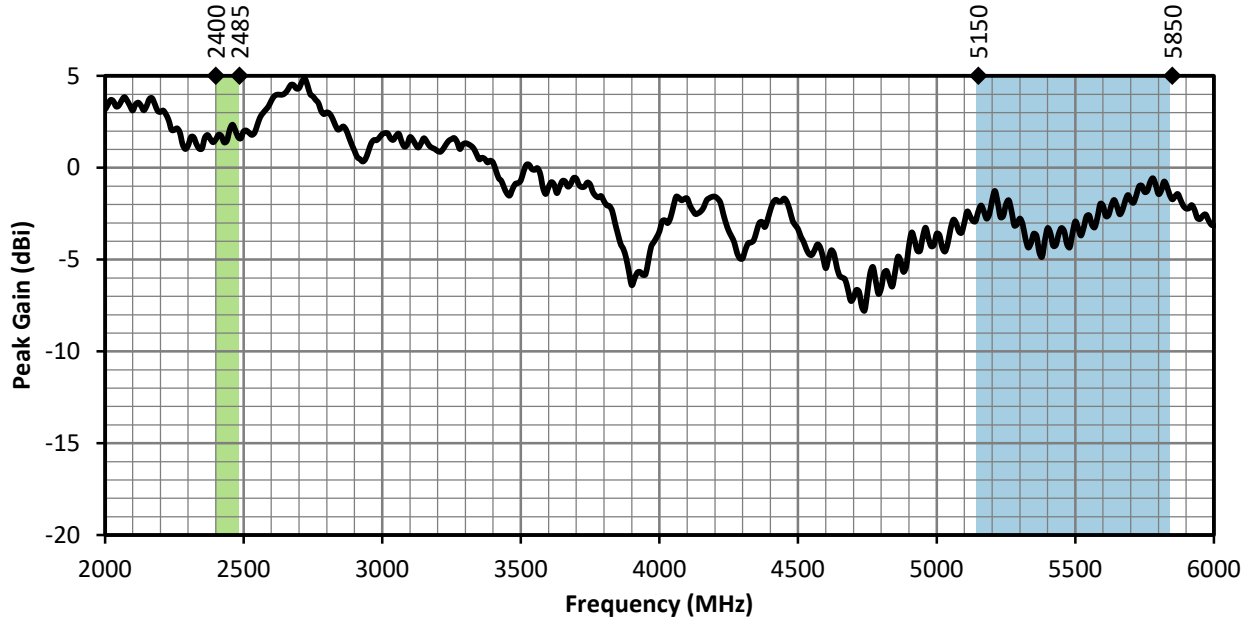

Figure 4. ANT- 2/5-VDP-2000 Peak Gain with Frequency Band Highlights

Average Gain

Average gain (Figure 5), is the average of all antenna gain in 3-dimensional space at each frequency, providing an indication of overall performance without expressing antenna directionality.

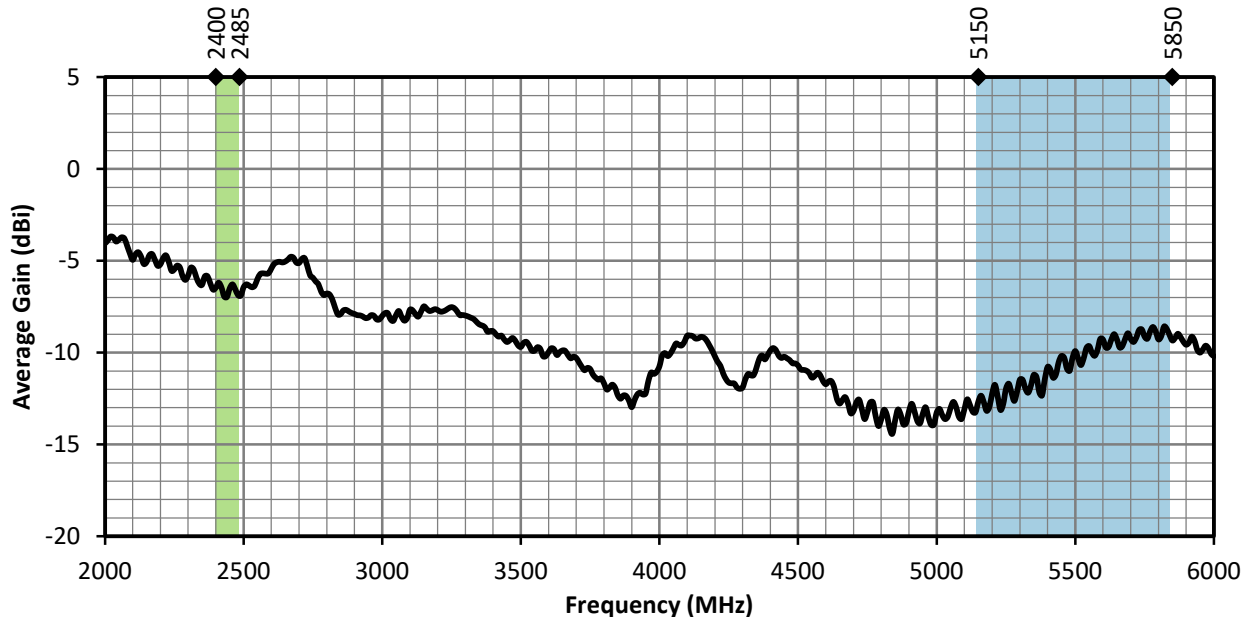

Figure 5. ANT- 2/5-VDP-2000 Antenna Average Gain with Frequency Band Highlights

Radiation Efficiency

Radiation efficiency (Figure 6), shows the ratio of power delivered to the antenna relative to the power radiated at the antenna, expressed as a percentage, where a higher percentage indicates better performance at a given frequency.

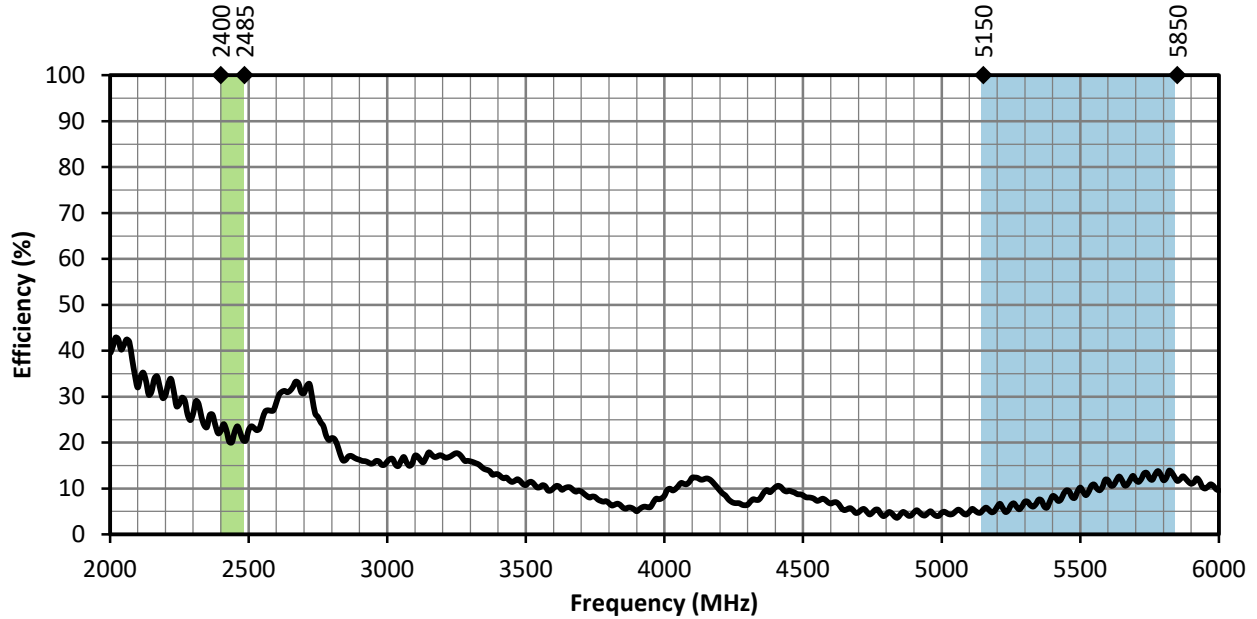
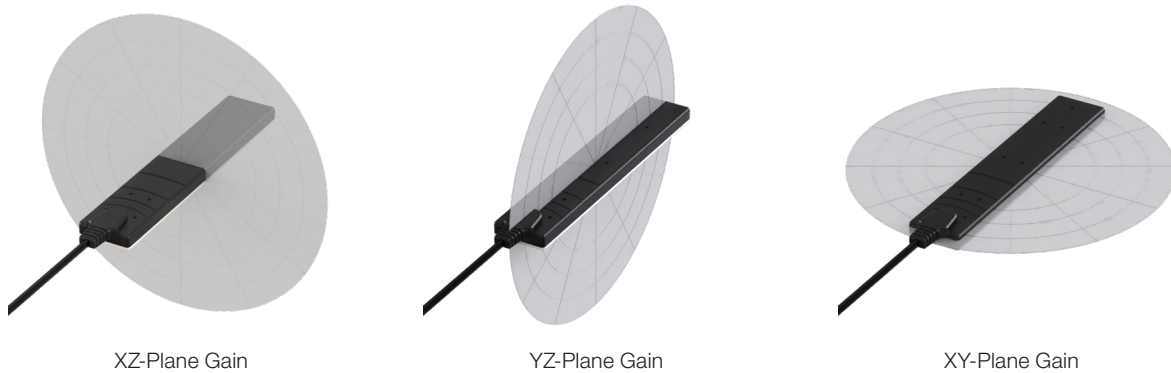

Figure 6. ANT- 2/5-VDP-2000 Antenna Radiation Efficiency with Frequency Band Highlights

Radiation Patterns

Radiation patterns provide information about the directionality and 3-dimensional gain performance of the antenna by plotting gain at specific frequencies in three orthogonal planes. Antenna radiation patterns are shown in Figure 7 using polar plots covering 360 degrees. The antenna graphic at the top of the page provides reference to the plane of the column of plots below it. Note: when viewed with typical PDF viewing software, zooming into radiation patterns is possible to reveal fine detail.



Radiation Patterns



XZ-Plane Gain



YZ-Plane Gain



XY-Plane Gain

2400 MHz to 2485 MHz (2450 MHz)

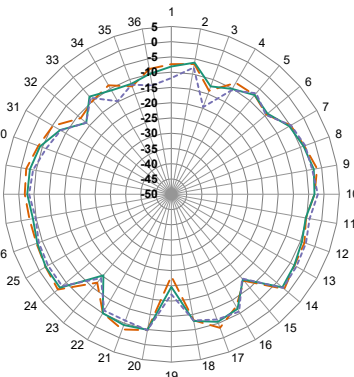

XZ-Plane Gain

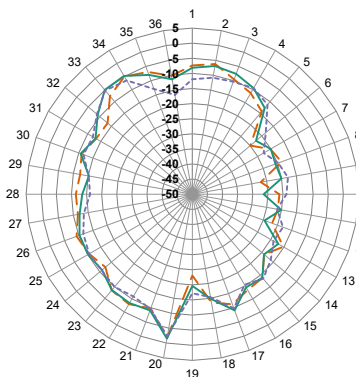

YZ-Plane Gain

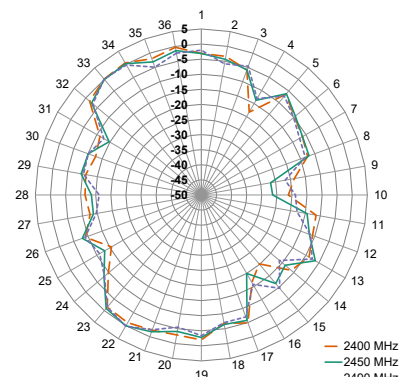

XY-Plane Gain

— 2400 MHz
— 2450 MHz
- - 2490 MHz

5150 MHz to 5850 MHz (5500 MHz)

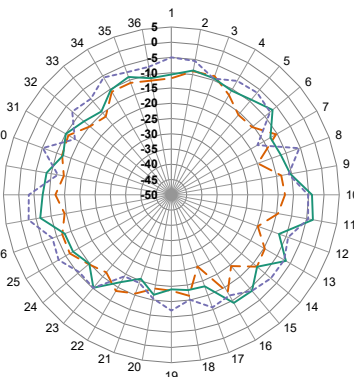

XZ-Plane Gain

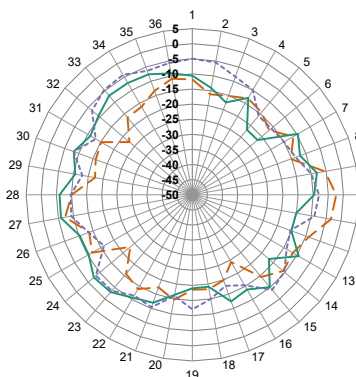

YZ-Plane Gain

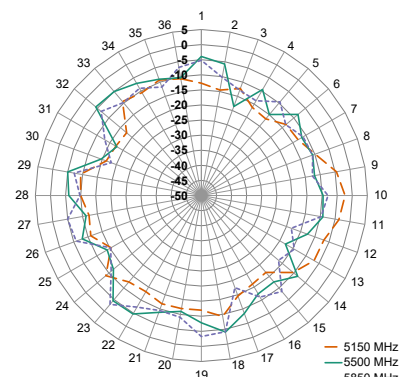

XY-Plane Gain

— 5150 MHz
— 5500 MHz
- - 5850 MHz

Figure 7. ANT-2/5-VDP-2000 Radiation Patterns

Datasheet

Antenna Definitions and Useful Formulas

VSWR - Voltage Standing Wave Ratio. VSWR is a unitless ratio that describes the power reflected from the antenna back to the radio. A lower VSWR value indicates better antenna performance at a given frequency. VSWR is easily derived from Return Loss.

$$\text{VSWR} = \frac{10^{\left[\frac{\text{Return Loss}}{20}\right]} + 1}{10^{\left[\frac{\text{Return Loss}}{20}\right]} - 1}$$

Return Loss - Return loss represents the loss in power at the antenna due to reflected signals, measured in decibels. A lower return loss value indicates better antenna performance at a given frequency. Return Loss is easily derived from VSWR.

$$\text{Return Loss} = -20 \log_{10} \left[\frac{\text{VSWR} - 1}{\text{VSWR} + 1} \right]$$

Efficiency (η) - The total power radiated from an antenna divided by the input power at the feed point of the antenna as a percentage.

Total Radiated Efficiency - (TRE) The total efficiency of an antenna solution comprising the radiation efficiency of the antenna and the transmitted (forward) efficiency from the transmitter.

$$\text{TRE} = \eta \cdot \left(1 - \left(\frac{\text{VSWR} - 1}{\text{VSWR} + 1} \right)^2 \right)$$

Gain - The ratio of an antenna's efficiency in a given direction (G) to the power produced by a theoretical lossless (100% efficient) isotropic antenna. The gain of an antenna is almost always expressed in decibels.

$$G_{\text{db}} = 10 \log_{10}(G)$$

$$G_{\text{dBd}} = G_{\text{dBi}} - 2.51\text{dB}$$

Peak Gain - The highest antenna gain across all directions for a given frequency range. A directional antenna will have a very high peak gain compared to average gain.

Average Gain - The average gain across all directions for a given frequency range.

Maximum Power - The maximum signal power which may be applied to an antenna feed point, typically measured in watts (W).

Reflected Power - A portion of the forward power reflected back toward the amplifier due to a mismatch at the antenna port.

$$\left(\frac{\text{VSWR} - 1}{\text{VSWR} + 1} \right)^2$$

decibel (dB) - A logarithmic unit of measure of the power of an electrical signal.

decibel isotropic (dBi) - A comparative measure in decibels between an antenna under test and an isotropic radiator.

decibel relative to a dipole (dBd) - A comparative measure in decibels between an antenna under test and an ideal half-wave dipole.

Dipole - An ideal dipole comprises a straight electrical conductor measuring 1/2 wavelength from end to end connected at the center to a feed point for the radio.

Isotropic Radiator - A theoretical antenna which radiates energy equally in all directions as a perfect sphere.

Omnidirectional - Term describing an antenna radiation pattern that is uniform in all directions. An isotropic antenna is the theoretical perfect omnidirectional antenna. An ideal dipole antenna has a donut-shaped radiation pattern and other practical antenna implementations will have less perfect but generally omnidirectional radiation patterns which are typically plotted on three axes.

Website: <http://linxtechnologies.com>
Linx Offices: 159 Ort Lane, Merlin, OR, US 97532
Phone: +1 (541) 471-6256
E-MAIL: info@linxtechnologies.com

Linx Technologies reserves the right to make changes to the product(s) or information contained herein without notice. No liability is assumed as a result of their use or application. No rights under any patent accompany the sale of any such product(s) or information.

Wireless Made Simple is a registered trademark of Linx Acquisitions LLC. Other product and brand names may be trademarks or registered trademarks of their respective owners.

Copyright © 2021 Linx Technologies

All Rights Reserved

Doc# DS21084-84ANT Replaces (Dated Release 3/12/2018)

