



KS156-AL

Atom



Features

- 15.6" 1366x768 TFT LCD Panel with Touch Screen
- 1x 2.5" SATA drive bay
- IP65 Front Panel Protection
- VESA/Panel Mount
- Rich I/O: 2 LAN, 2 COM, 4 USB 3.0



Panel

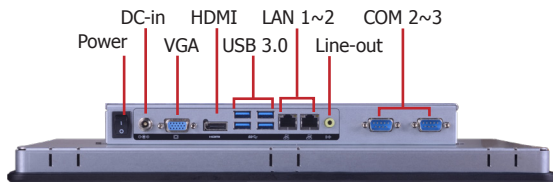

Bottom View

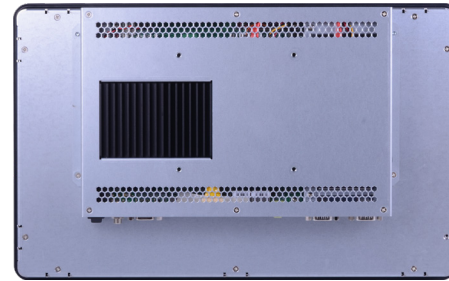

Rear View

Dimensions

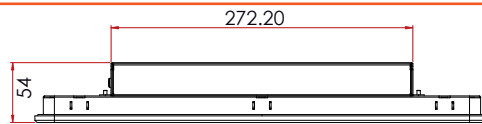

Top View



Left View

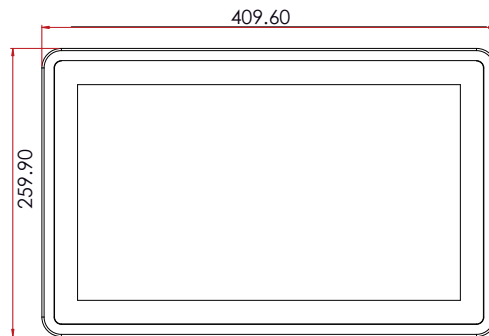

Front View

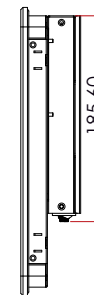

Right View



Bottom View

Specifications

SYSTEM	Processor	Intel Atom® Processor E3900 Family, BGA 1296 Intel Atom® x5-E3940 Processor, Quad Core, 2M Cache, 1.6GHz (1.8GHz), 9.5W Intel® Pentium® Processor N4200, Quad Core, 2M Cache, 1.1GHz (2.5GHz), 6W
	Memory	Two 204-pin SODIMM up to 16GB Dual Channel DDR3L 1867MHz
	BIOS	Insyde SPI 64Mbit (supports UEFI boot only)
DISPLAY AND TOUCH SCREEN	Display	15.6" 1366x768 TFT LCD Panel with Capacitive/5-Wire Resistive Touch Screen
	Brightness	400 cd/m ²
	Contrast	500:1
	Backlight Lifetime	50,000 hours
GRAPHICS	Controller	Intel® HD Graphics
	Feature	OpenGL 5.0, DirectX 12, OpenCL 2.1 HW Decode: AVC/H.264, MPEG2, VC1/WMV9, JPEG/MJPEG, HEVC/H.265, VP8, VP9, MVC HW Encode: AVC/H.264, JPEG/MJPEG, HEVC/H.265, VP8, VP9, MVC
	Display	1 x VGA VGA: resolution up to 1920x1200 @ 60Hz 1 x HDMI HDMI: resolution up to 3840x2160 @ 30Hz
	Dual Displays	HDMI + VGA
STORAGE EXPANSION		1 x 2.5" SATA 3.0 Drive Bay
AUDIO	Audio Codec	Realtek ALC888 5.1-channel
ETHERNET	Controller	2 x Intel® I210AT PCIe (10/100/1000Mbps)
LED	Indicators	1 x Power LED 1 x HDD LED
TOP I/O	Antenna Connectors	2 x Antenna Hole for Wi-Fi or Cell Module
BOTTOM I/O	Ethernet	2 x GbE (RJ-45) (10/100/1000Mbps)
	Serial	2 x RS-232/422/485 (DB-9)
	USB	4 x USB 3.0 (type A)
	Display	1 x VGA 1 x HDMI
	Audio	1 x Line-out
	Buttons	1 x Power Button
WATCHDOG TIMER	Output & Interval	System Reset, Programmable via Software from 1 to 255 Seconds
POWER	Type	12V DC 15V - 36V DC
	Connector	DC Jack
	OS SUPPORT (UEFI ONLY)	Windows 10 (64-bit) Yocto Project Fedora 24 (Intel Graphics Driver available) Linux
MECHANISM	Construction	Sheet Metal
	IP Rating	IP65 Front Panel Protection
	Mounting	Panel/VESA Mount
	Dimensions (W x H x D)	409.6 mm x 259.9 mm x 54 mm (W x H x D)
	Weight	5kg/6.3kg (NW/GW)
ENVIRONMENT	Operating Temperature	0 to 50°C
	Storage Temperature	-30 to 70°C
	Relative Humidity	5 to 85% RH (non-condensing)
STANDARDS AND CERTIFICATIONS	Shock	OP: Half-sine, 3G @ 11ms Non-OP: Half-sine, 5G @ 11ms
	Vibration	OP: Random, 1Grms @ 5~500Hz, 30min Non-OP: Sweep sine, 3Grms @ 10~500Hz, 30min
	Certifications	CE/FCC



KS156-AL

▶ VESA Mounting

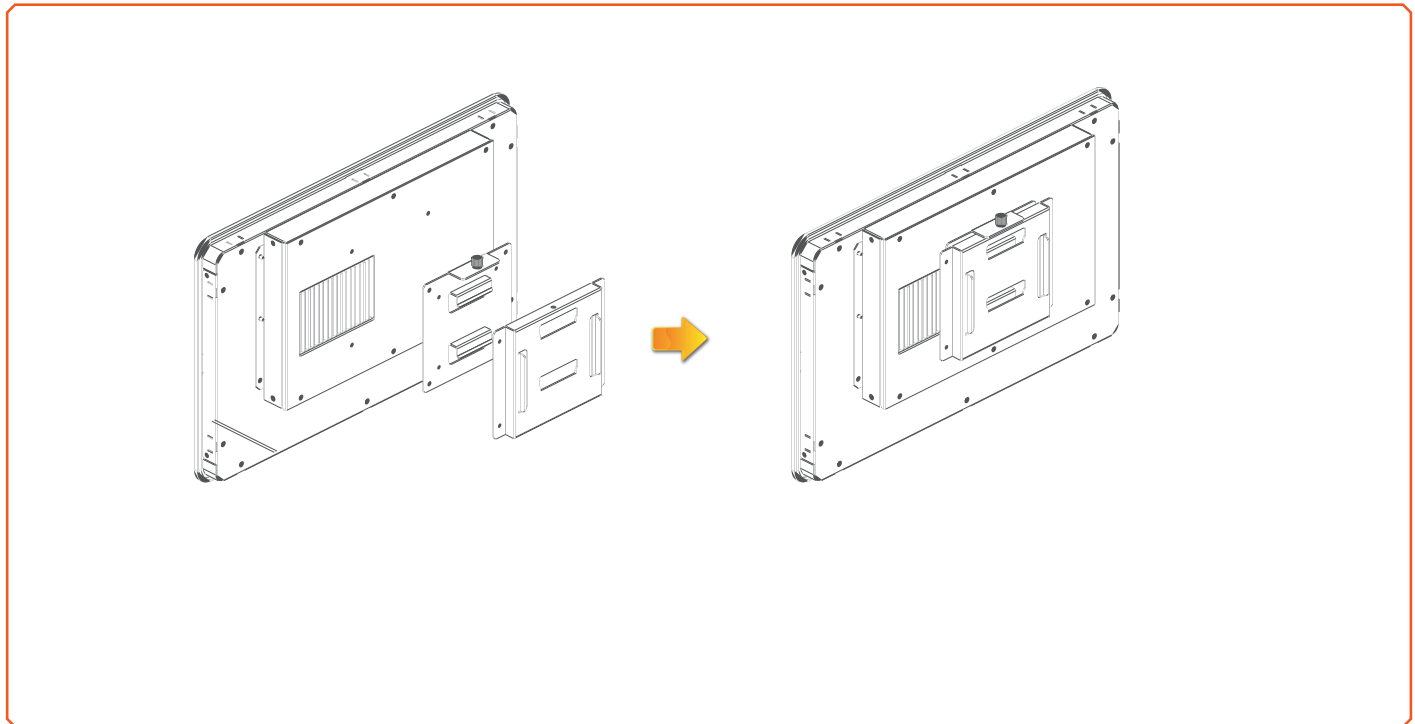

▶ Panel Mounting

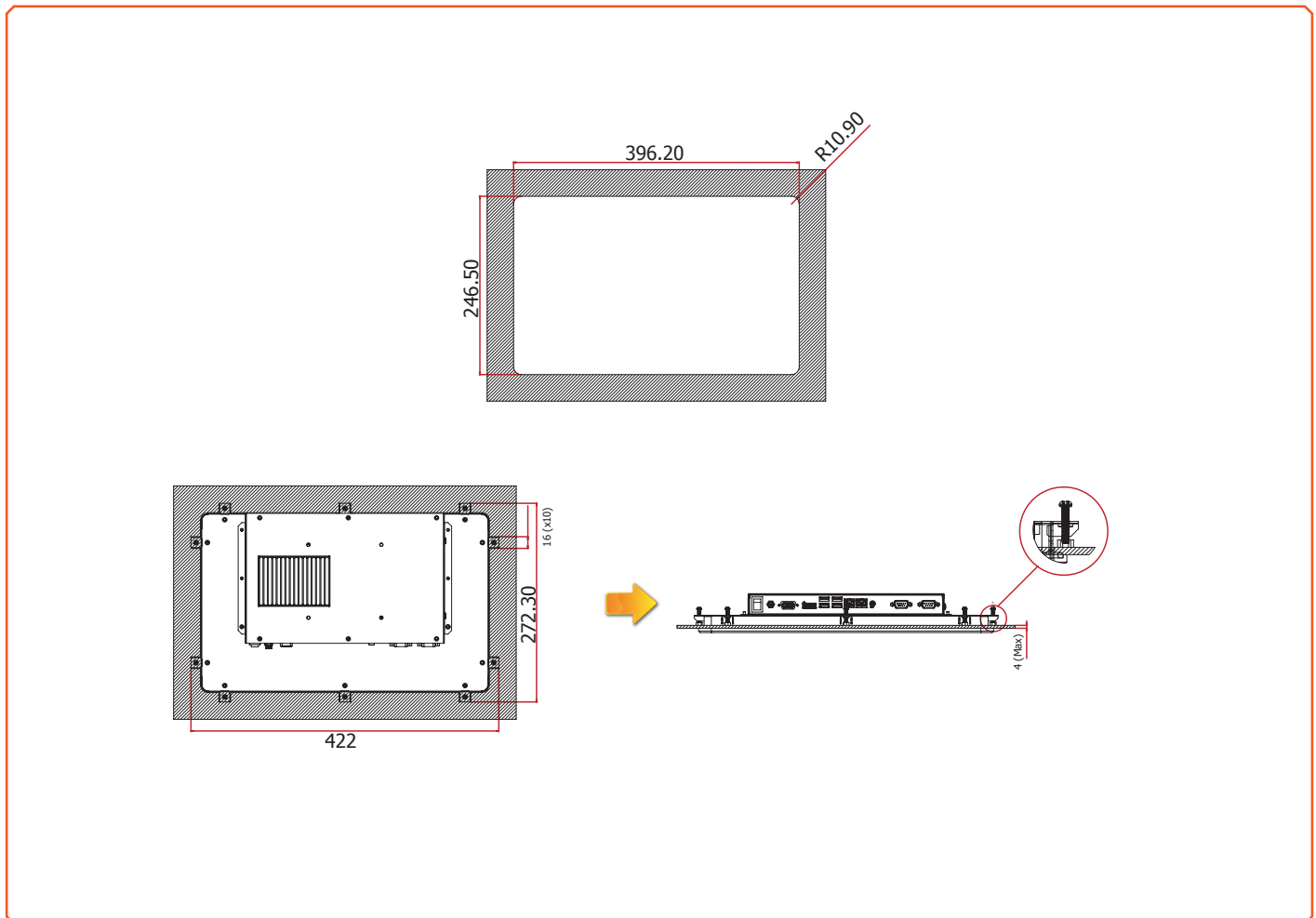

► Ordering Information

Model Name	Part Number	Description
KS156P-ALWD36-4200	750-KS1561-000G	15.6" Panel PC ; AL173, Intel Atom N4200, 4G RAM, 15-36VDC input, PCT, F/G SYSTEM, RoHs
KS156R-ALWD36-4200	750-KS1561-100G	15.6" Panel PC ; AL173, Intel Atom N4200, 4G RAM, 15-36VDC input, 5-wire Resistive Touch, F/S SYSTEM, RoHs
KS156P-ALWD36-3940	750-KS1561-200G	15.6" Panel PC ; AL173, Intel Atom E3940, 4G RAM, 15-36VDC input, PCT, F/G SYSTEM, RoHs
KS156P-ALDC12-3940	750-KS1560-200G	15.6" Panel PC ; AL171, Intel Atom E3940, 4G RAM, 12VDC input, PCT, F/G SYSTEM, RoHS

► Optional Items

Optional Items	Part Number	Description
Memory	138-340001-109G	DDR3L SO-DIMM 204-pin, 4GB
Wi-Fi	761-110091-000G	Wi-Fi kit, RoHS
Power Cord	332-700010-201G	Power cord, Standards (USA), 1.8m, RoHS
Power Adapter	671-112005-100G	120W, 24V/5V, Level 6, RoHS
Power Adapter	671-106013-000G	60W, 12V/5V, Level 6, RoHS
Panel Mount	761-KS1560-000G	Panel PC Panel Mount Kit, RoHS

► Packing List

• 1 KS156-AL Touch Panel PC
• 1 Poron foam
• 1 Quick Installation Guide