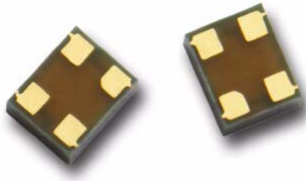


# Agilent ACPF-7002 High Rejection Tx Filter for US PCS Band Data Sheet



## Features

- **High rejection from a single filter  
With no switches required.**
- **Passband: 1850-1910 MHz  
33 dB min Attenuation,  
1930-1990 MHz  
2.5 dB Typical Insertion Loss**
- **Space saving solution  
Small footprint:  
1.6 x 2.0-mm solution  
Low profile package:  
0.9 mm high (Typ)  
1.0 mm (MAX)**

## Applications

- **US PCS band handsets**
- **Wireless Data terminals**

## General Description

The ACPF-7002 is a high rejection full band transmit filter designed for US PCS handsets. Its performance rivals splitband surface acoustic wave (SAW) transmit filters. Since a single filter provides the rejection, no switches are required, saving board space and external components, eliminating switch loss, and reducing programming complexity.

The ACPF-7002 FBAR transmit filter utilizes Agilent's Microcap bonded-wafer chip scale packaging technology. This process allows the ultra small filters to be assembled into a Molded Chip on Board (MCOB) module.

In typical cellular phone architectures, the transmit filter fits between the driver amplifier and the Power Amplifier. The ACPF-7002 FBAR filter reduces the noise in the Rx band being amplified by the transmit chain, enhancing receiver sensitivity. High rejection keeps unwanted signals out of the receive path.

Agilent's thin-Film Bulk Acoustic Resonator (FBAR) technology makes possible high-Q filters at a fraction their usual size.

## Electrical Specifications, $Z_0=50\ \Omega$

Symbol	Parameters	Units	+25° C			-30° to +25° C			25° to +85° C		
			Min	Typ	Max	Min	Typ	Max	Min	Typ	Max
f	Passband	MHz	1850		1910	1850		1910	1850		1910
IL	Insertion Loss 1850-1855 MHz	dB		2.0	3.5			3.7			3.2
IL	Insertion Loss 1855-1905 MHz	dB		1.5	2.5			2.5			2.5
IL	Insertion Loss 1905-1910 MHz	dB		2.5	3.0			2.7			3.7
D S21	Ripple, 1850-1910 MHz	dB			2.5						
S21	Min Rejection, 1930-1990 MHz	dB	33	37		33			33		
S21	Min Rejection 10 –1800 MHz	dB	25			25			25		
S21	Min Rejection 1990 – 3820 MHz	dB	22			22			22		
S21	Min Rejection 3820 – 5730 MHz	dB	15.0			15.0			15.0		
S11, S22	In-band return loss	dB	9.0	11		9.0	11		9.0	11	
Pin max	Safe Input Power Level	dBm	20			20			20		

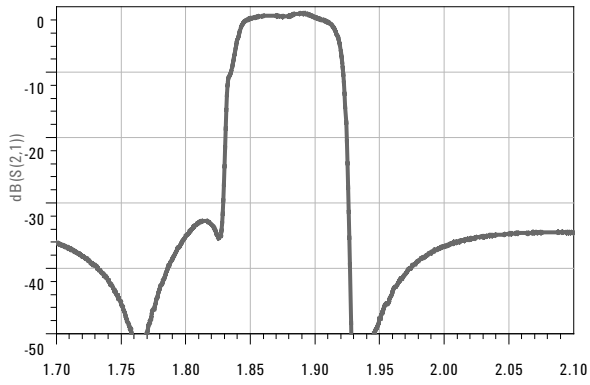
## Absolute Maximum Ratings<sup>[2]</sup>

Parameter	Unit	Value
Operating temperature <sup>[1]</sup>	°C	-30 to +85
Storage temperature <sup>[1]</sup>	°C	-30 to +100

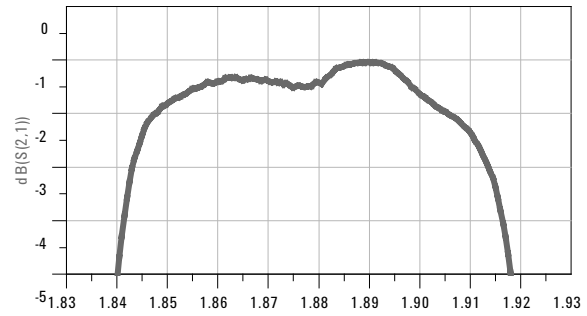
### Notes:

1. Temperature is defined at case  $T_C$ , the temperature of the underside of the filter where it makes contact with the circuit board.
2. Specifications are guaranteed over the given temperature range. Operation in excess of any one of these conditions may result in permanent damage to the device.

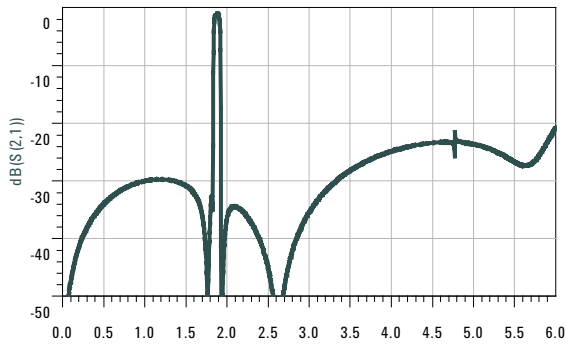
**Typical Performance (25° C, Zo = 50 Ohms)**



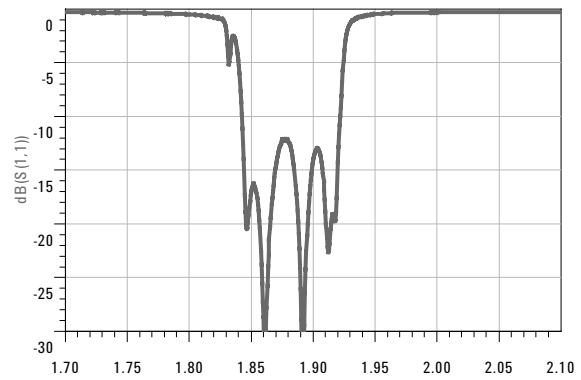
**Figure 1. Attenuation [dB] vs. Frequency**



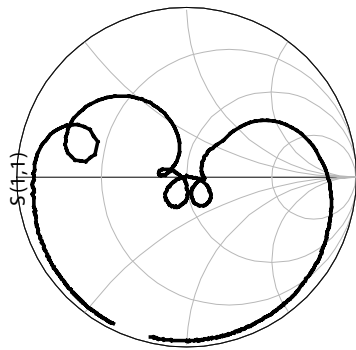
**Figure 2. Insertion Loss [dB] vs. Frequency**



**Figure 3. Attenuation [dB] vs. Frequency (broadband)**

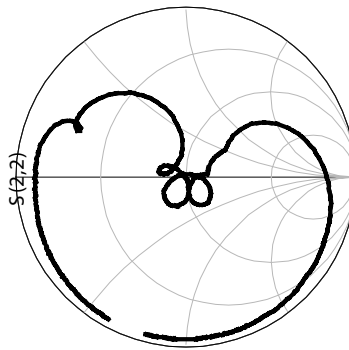


**Figure 4. Return Loss [dB] vs. Frequency**



freq (1.700GHz to 2.100GHz)

**Figure 5. Typical S(1,1)**



freq (1.700GHz to 2.100GHz)

**Figure 6. Typical S(2,2)**

## PCB Interface & Mounting instructions

### Mounting Consideration and board description

The ACPF-7002 FBAR filter has one input (Pin 1), one output (Pin 3) and two grounds (Pins 2, 4).

- Demo board uses 3 mil Getek Microstrip.

The demoboard uses CPWG transmission lines for high isolation between the two ports. It uses via holes to connect the CPWG line from the underside of the board to the filter mounting pads on top.

#### Note:

For best performance, try to reproduce this board stack up closely. If Ground-Signal-Ground (GSG) type board is used, better return loss can be achieved since it eliminates connector mismatch.

### Demo boards

Demo boards are available.  
(See board drawing in Figure 7, 8, 9).

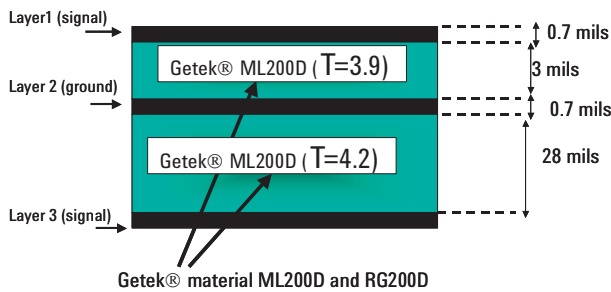


Figure 7. Board stack up description

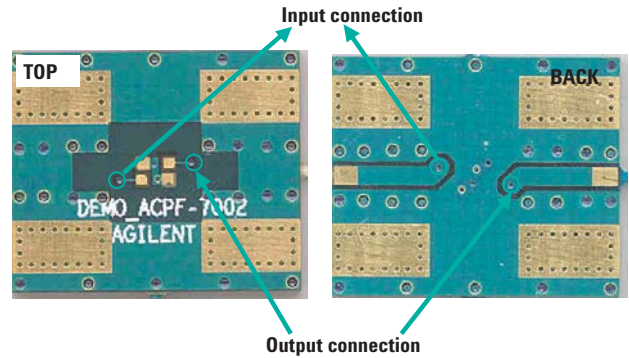


Figure 8. PCB Footprint pad

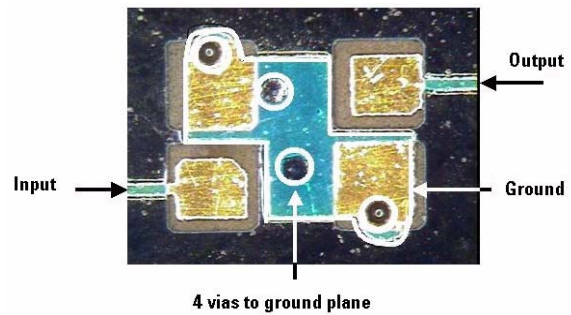


Figure 9. Closer look at the recommended board footprint and soldermask

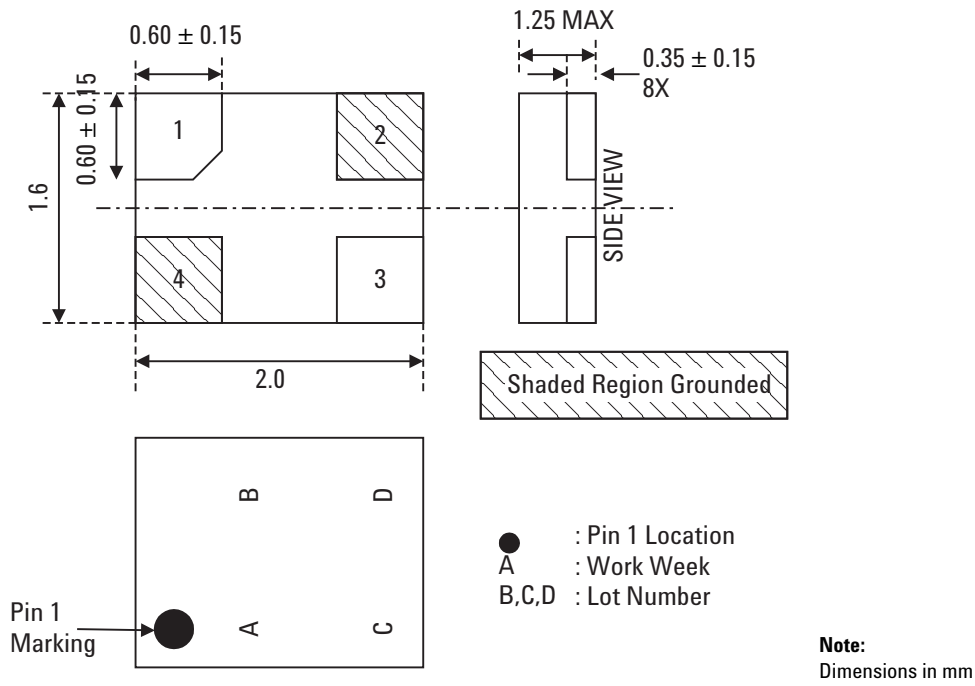
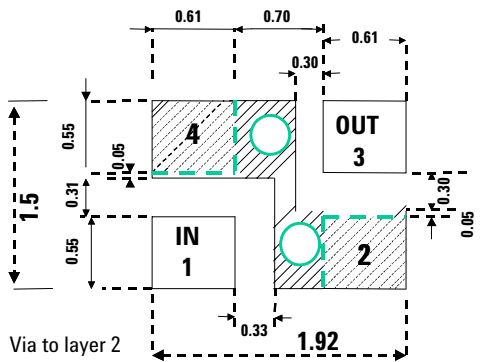


Figure 10. Detailed Bottom, Side and Top view of Package

Layer 1



Note:  
Dimensions in mm

Layer 2 (GROUND layer)

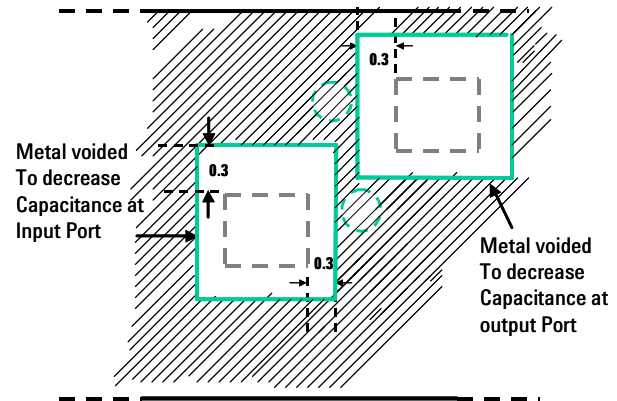


Figure 11. Suggested PCB layers, viewed from top

## Solder Compositions

Alloy type	Melting temp. (°C)	Recommended working temperature (°C)
Sn42Bi58	138	160 – 180
Sn43Pb43Bi14	144 – 163	165 – 185
Sn63Pb37	183	200 – 240
Sn60Pb40	186	200 – 240
Sn91/Zn9	199	200 – 240
Sn96.2Ag2.5Cu0.8Sb0.5	216	235 – 255
Sn95.8Ag3.5Cu0.7	217	235 – 255
Sn96.5Ag3.5	221	240 – 260
Sn100	232	260 – 280
Sn95Sb5	235	260 – 280
Sn97Cu3	240	260 – 300

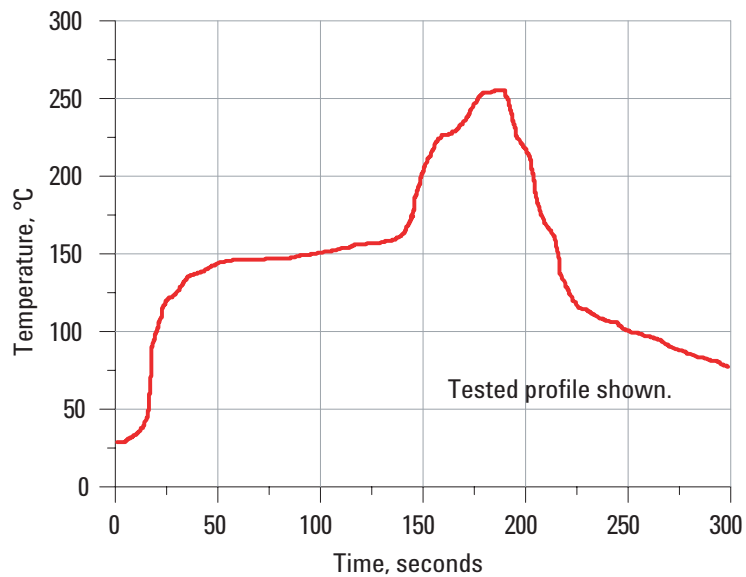
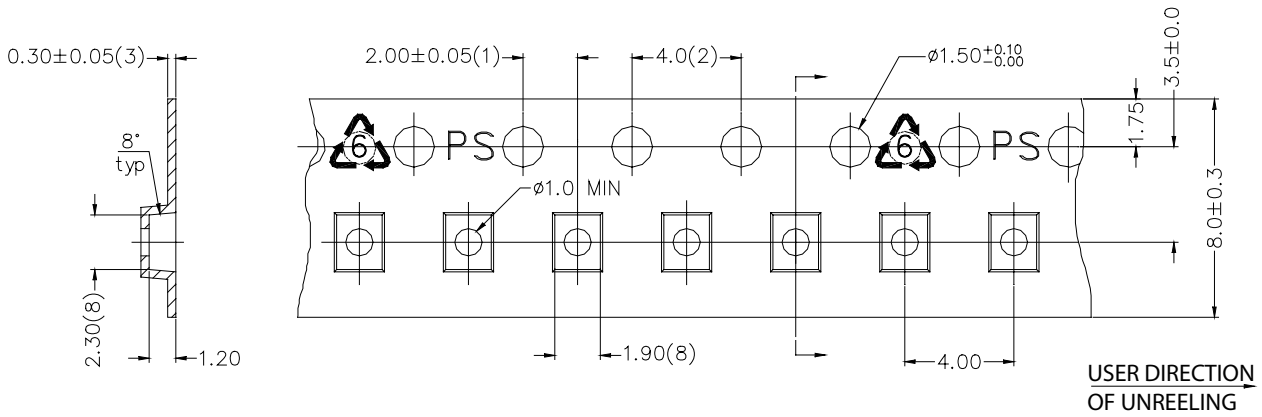


Figure 12. Recommended solder profile



NOTES:

1. MEASURED FROM THE CENTRELINE OF THE SPROCKET HOLE TO THE CENTRELINE OF THE POCKET HOLE AND FROM THE CENTRELINE OF THE SPROCKET HOLE TO THE CENTERLINE OF THE POCKET
2. CUMULATIVE TOLERANCE OF 10 SPROCKET HOLES IS  $\pm 0.20$
3. THIS THICKNESS IS APPLICABLE AS MEASURED AT THE EDGE OF THE TAPE.
4. MATERIAL: BLACK POLYSTYRENE
5. ALL DIMENSIONS IN MM.
6. ALLOWABLE CAMBER TO BE 1MM PER 250MM IN LENGTH
7. UNLESS OTHERWISE SPECIFIED TOLERANCE  $\pm 0.10$ .
8. MEASUREMENT POINT TO BE 0.3 FROM BOTTOM POCKET.
9. SURFACE RESISITVY FROM  $1.0 \times 10^5$  TO  $1.0 \times 10^{11}$  OHMS/SQ

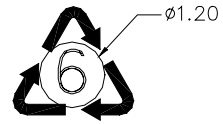
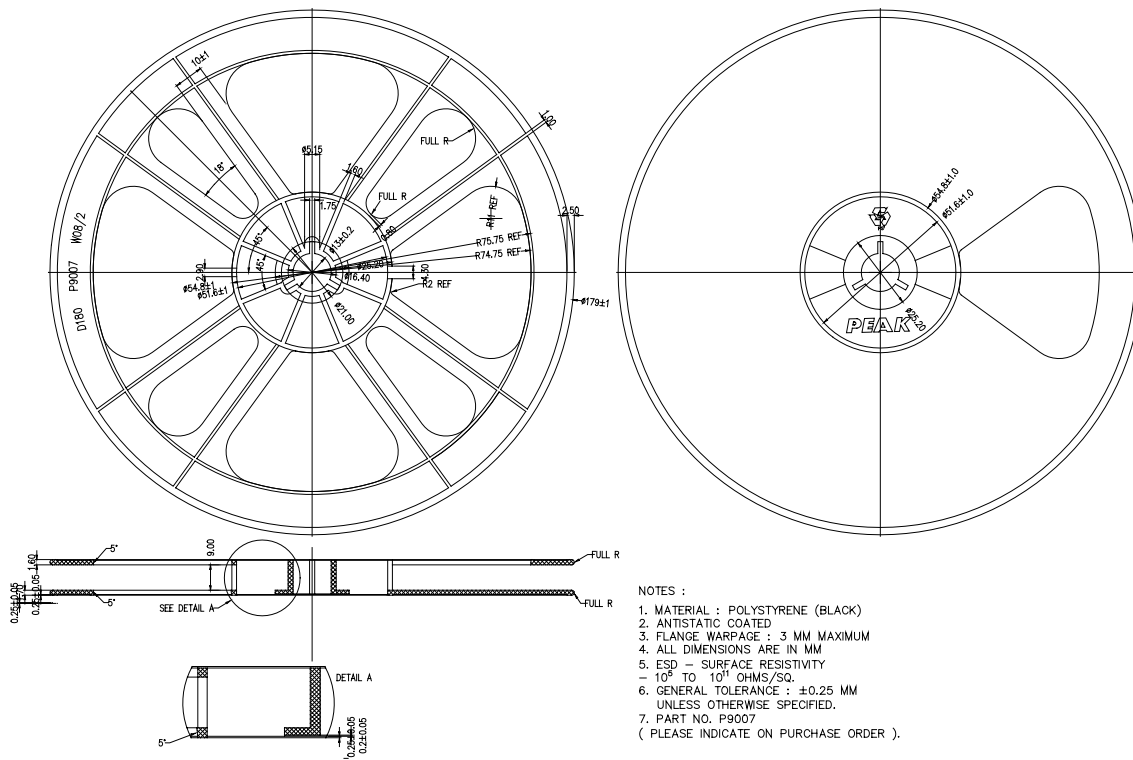
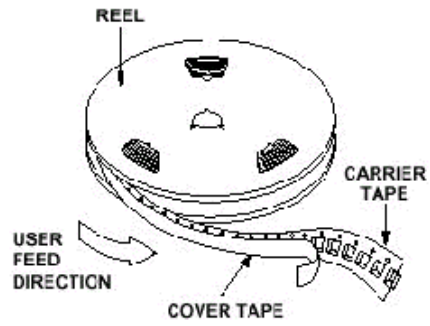


Figure 13. Tape drawing



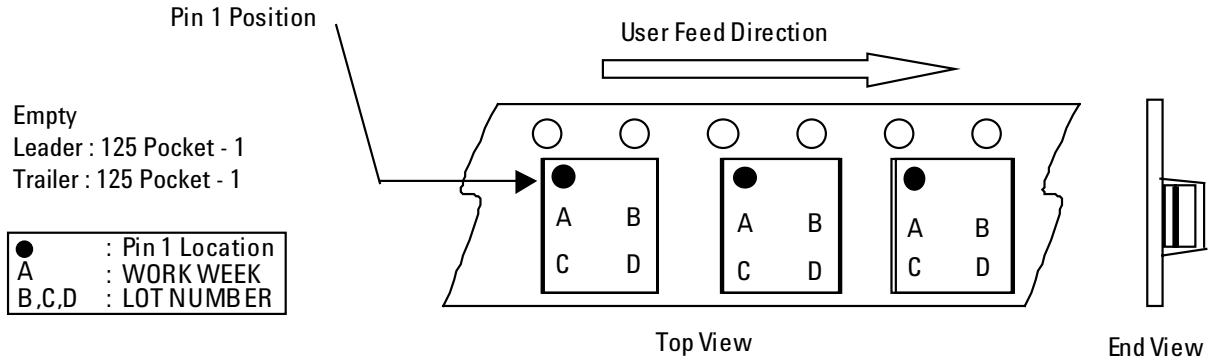
- NOTES :
1. MATERIAL : POLYSTYRENE (BLACK)
  2. ANTISTATIC COATED
  3. FLANGE WARPAGE : 3 MM MAXIMUM
  4. ALL DIMENSIONS ARE IN MM
  5. ESD – SURFACE RESISTIVITY  
-  $10^5$  TO  $10^{11}$  OHMS/SQ.
  6. GENERAL TOLERANCE :  $\pm 0.25$  MM  
UNLESS OTHERWISE SPECIFIED.
  7. PART NO. P9007  
( PLEASE INDICATE ON PURCHASE ORDER ).

Figure 14. Reel drawing



**Notes:**

1. Material Polyester and Acrylic Adhesive Layers.
2. All Dimensions in MM except tape length.
3. Surface Resistivity:  $10^6$  to  $10^{12}$  OHMS/SQ.



**Figure 15. Device orientation in the tape**

**Ordering information**

Specify part number followed by option. For example:

ACPF - 7002 - XXX

- BLK = Bulk, Min 100pcs per antistatic bag
- TR1 = Tape and Reel, 3000pcs per 7" reel

[www.agilent.com/semiconductors](http://www.agilent.com/semiconductors)

For product information and a complete list of distributors, please go to our web site.

Data subject to change.  
Copyright 2003 Agilent Technologies, Inc.  
January 21, 2004  
5989-0380EN

