

Toggle Switches, MT Series, Wire Lug, Long Bat Actuator

MATERIAL SPECIFICATIONS:

ContactsGold flash over silver
 Actuator MaterialChrome plated copper alloy
 Case MaterialThermoset 94V-0
 TerminalsGold flash
 Terminal SealEpoxy

ENVIRONMENTAL SPECIFICATIONS

Operating Temperature4°F to +176°F (-20°C to +80°C)
 Storage Temperature-40°F to +176°F (-40°C to +80°C)
 Solder Heat Resistance.....See page M3-4

UL Available when ordering . . . Consult factory.

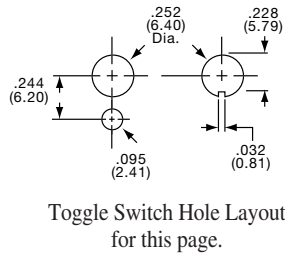
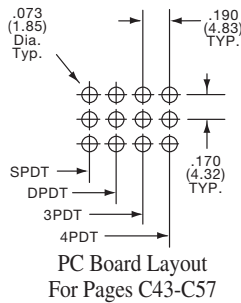

TYPICAL PERFORMANCE CHARACTERISTICS:

Contact Rating6 A @ 125 VAC, 3 A @ 250 VAC,
 4A @ 28 VDC
 Initial Contact Resistance.....20 Milliohms max.
 Contact Timing.....Break before make
 Insulation Resistance1,000 Megohms min. @ 500 VDC
 min. for 1 minute
 Dielectric Strength1,500 VAC
 Actuation Force05-1.5 kg.
 Actuator Travel24" (26° on MTL Series)
 High Torque Bushing ShoulderStandard
 Life ExpectancySee chart below.

NOTICE: For terminal connections refer to Code Chart Page M5-6.

Note: Hardware included with all switches

Green Series toggle life expectancy chart			
Parameter	2 Pos.	3 Pos.	Momentary
Mechanical (no load)	150,000	100,000	60,000
250AC (3A Resistive)	80,000	60,000	60,000
125AC (6A Resistive)	80,000	60,000	60,000
28DC(4) (Resistive)	60,000	50,000	40,000

SPDT/DPDT/SP3T

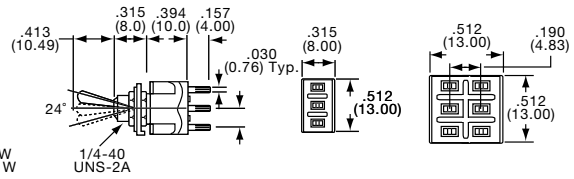
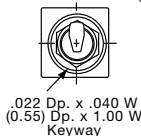
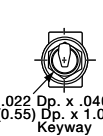
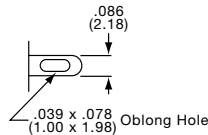

Tyco Electronics	Alcoswitch	Type	Act. Code	P. M5	On	None	On	Tyco Electronics	Alcoswitch	Type	Act. Code	P. M5	On	None	On
1-1437558-0	MTA106D	SPDT	1		On	None	On	2-1437558-0	MTA206N	DPDT	2		On	None	On
1-1437558-2	MTA106E	SPDT	5		On	Off	On	2-1437558-2	MTA206P	DPDT	6		On	Off	On
1-1437558-4	MTA106F	SPDT	1		On	None	(On)	2-1437558-7	MTA206R	DPDT	2		On	None	(On)
1-1437558-6	MTA106G	SPDT	5		(On)	Off	(On)	2-1437558-9	MTA206S	DPDT	6		(On)	Off	(On)
1-1437558-8	MTA106H	SPDT	5		On	Off	(On)	3-1437558-2	MTA206T	DPDT	6		On	Off	On
								2-1437558-3	*MTA206PA	SP3T	11		On	On	On
								3-1437558-0	*MTA206SA	SP3T	11		(On)	On	(On)
								3-1437558-3	*MTA206TA	SP3T	11		On	On	(On)

(On) indicates momentary position.

* Note: PA, SA & TA types have case .100(2.50) longer than other types.

3PDT/4PDT/DP3T

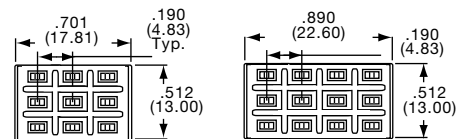
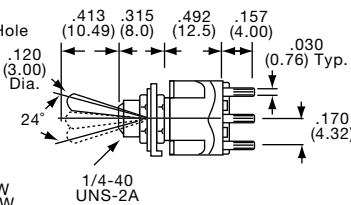
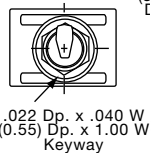
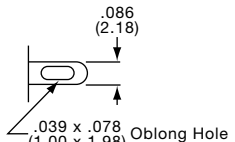

Tyco Electronics	Alcoswitch	Type	Act. Code	P. M5	On	None	On	Tyco Electronics	Alcoswitch	Type	Act. Code	P. M5	On	None	On
3-1437558-5	MTA306D	3PDT	3		On	None	On	4-1437558-3	MTA406N	4PDT	4		On	None	On
3-1437558-7	MTA306E	3PDT	7		On	Off	On	4-1437558-5	MTA406P	4PDT	8		On	Off	On
3-1437558-9	MTA306F	3PDT	3		On	None	(On)	4-1437558-6	*MTA406PA	DP3T	12		On	On	On
4-1437558-1	MTA306H	3PDT	7		On	Off	(On)								

(On) indicates momentary position.

*Note: PA types have case .100 (2.50) longer than other types.

Toggle Switches, MT Series, PC Tail, Long Bat Actuator

SEE PAGE C43 FOR PRODUCT SPECIFICATIONS

For terminal connections refer to Code Chart. (See Page M5-6)

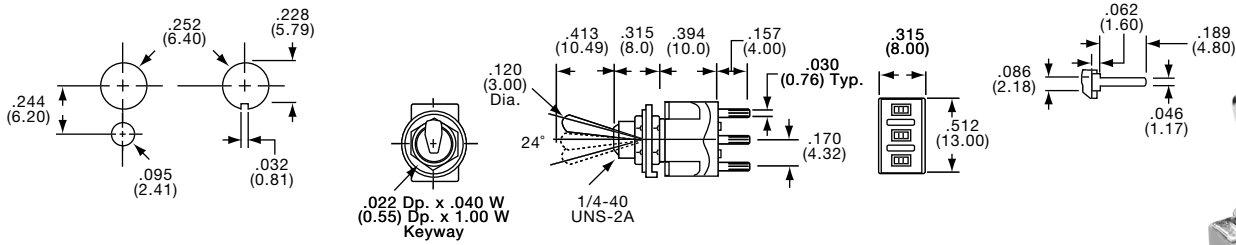

SPDT



MTA106DPC

Tyco Electronics	Alcoswitch	Type	Act. Code	P. M5	On	None	On
1-1437558-1	MTA106DPC	SPDT	1		On	None	On
1-1437558-3	MTA106EPC	SPDT	5		On	Off	On
1-1437558-5	MTA106FPC	SPDT	1		On	None	(On)

Tyco Electronics	Alcoswitch	Type	Act. Code	P. M5	On	None	On
1-1437558-7	MTA106GPC	SPDT	5		(On)	Off	(On)
1-1437558-9	MTA106HPC	SPDT	5		On	Off	(On)

(On) indicates momentary position.

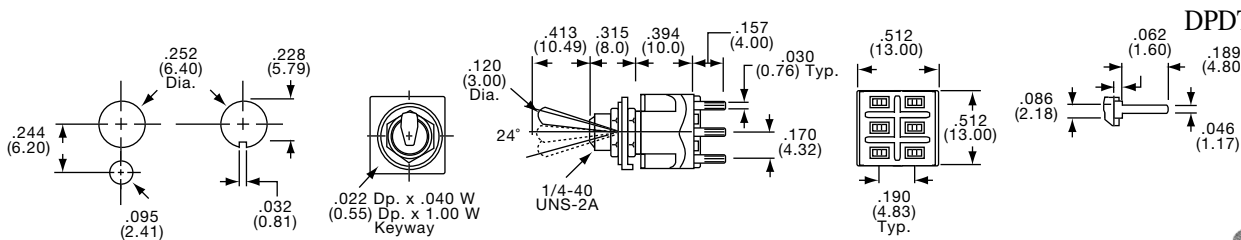

DPDT/SP3T



MTA206NPC

Tyco Electronics	Alcoswitch	Type	Act. Code	P. M5	On	None	On
2-1437558-1	MTA206NPC	DPDT	2		On	None	On
2-1437558-5	MTA206PPC	DPDT	6		On	Off	On
2-1437558-8	MTA206RPC	DPDT	2		On	None	(On)
3-1437558-1	MTA206SPC	DPDT	6		(On)	Off	(On)
3-1437558-4	MTA206TPC	DPDT	6		On	Off	(On)

Tyco Electronics	Alcoswitch	Type	Act. Code	P. M5	On	On	On
2-1437558-4	*MTA206PAPC	SP3T	11		On	On	On
	MTA206SAPC	SP3T	11		(On)	On	(On)

(On) indicates momentary position.
* Note: PA types - case .100(2.50) longer than other types.

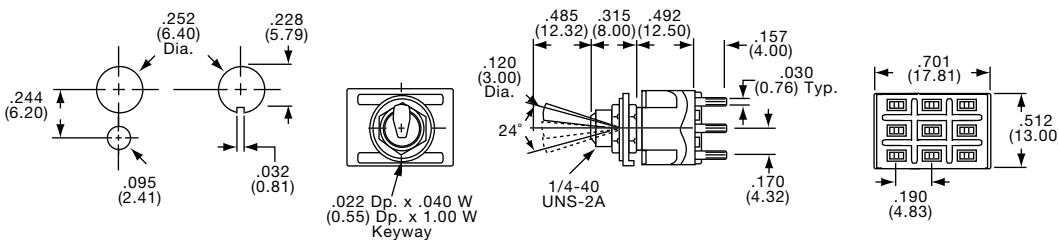

3PDT



MTA306DPC

Tyco Electronics	Alcoswitch	Type	Act. Code	P. M5	On	None	On
3-1437558-6	MTA306DPC	3PDT	3		On	None	On
3-1437558-8	MTA306EPC	3PDT	7		On	Off	On

Tyco Electronics	Alcoswitch	Type	Act. Code	P. M5	On	None	On
4-1437558-0	MTA306FPC	3PDT	3		On	None	(On)
4-1437558-2	MTA306HPC	3PDT	7		On	Off	(On)

(On) indicates momentary position.

4PDT/DP3T

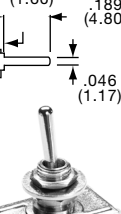

MTA406NPC

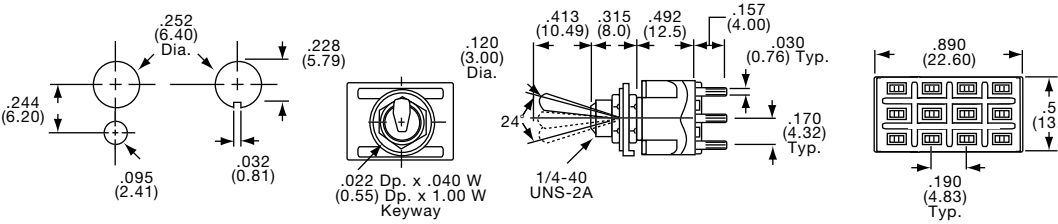

Tyco Electronics	Alcoswitch	Type	Act. Code	P. M5	On	None	On
4-1437558-4	MTA406NPC	4PDT	4		On	None	On
4-1437558-8	MTA406PPC	4PDT	8		On	Off	On

Tyco Electronics	Alcoswitch	Type	Act. Code	P. M5	On	On	On
4-1437558-7	MTA406PAPC	DP3T	12		On	On	On

Toggle Switches, MT Series, Wire Lug, Decorative Bat Actuator

SEE PAGE C43 FOR PRODUCT SPECIFICATIONS

For terminal connections refer to Code Chart. (See Page M5-6)

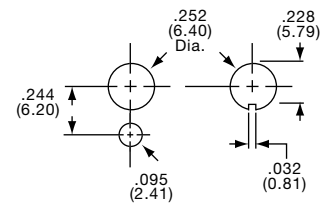
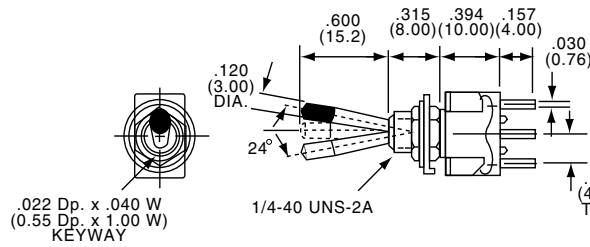

MTB106D

Tyco Electronics	Alcoswitch	Type	Act. Code	P. M5	On	None	On	Alcoswitch	Type	Act. Code	P. M5	On	None	On
6-1437558-3	MTB106D	SPDT	1		On	None	On	MTB106F	SPDT	1		On	None	(On)
6-1437558-2	MTB106E	SPDT	5		On	Off	On	MTB106G	SPDT	5		(On)	Off	(On)

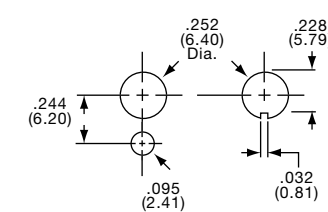
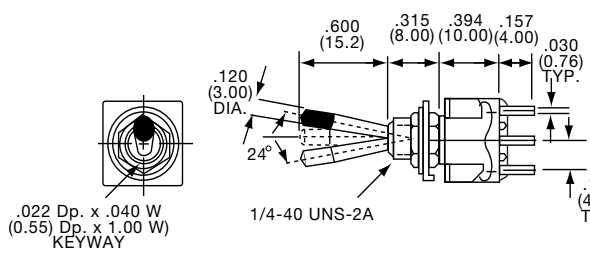
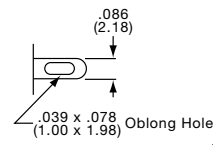

MTB206N

Tyco Electronics	Alcoswitch	Type	Act. Code	P. M5	On	None	On	Alcoswitch	Type	Act. Code	P. M5	On	None	On
6-1437558-4	MTB206N	DPDT	2		On	None	On	MTB206T	DPDT	6		On	Off	(On)
6-1437558-5	MTB206P	DPDT	6		On	Off	On							

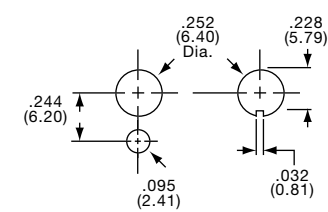
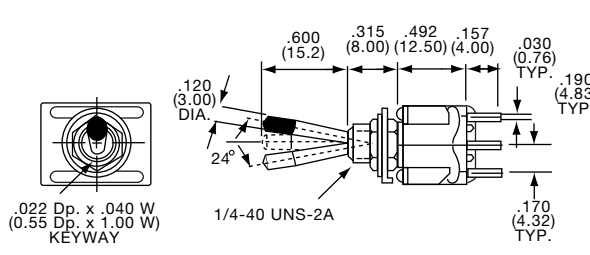
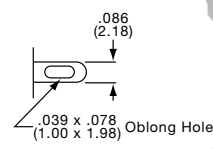

MTB306D

Tyco Electronics	Alcoswitch	Type	Act. Code	P. M5	On	None	On
6-1437558-6	MTB306D	3PDT	3		On	None	On

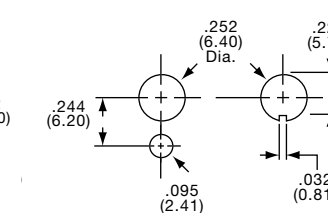
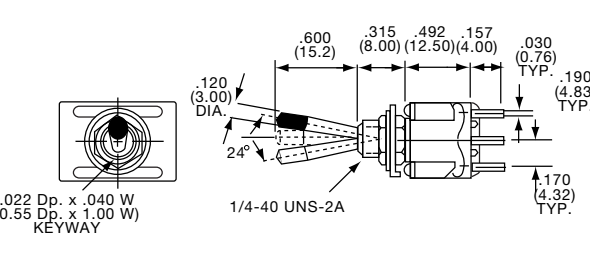
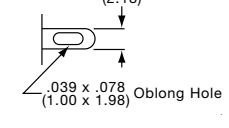

MTB406N

Tyco Electronics	Alcoswitch	Type	Act. Code	P. M5	On	None	On
6-1437558-7	MTB406N	4PDT	4		On	None	On

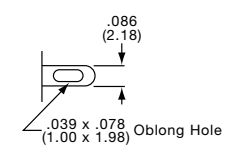

C
MTB Series

Toggle Switches, MT Series, Wire Lug, Splashproof Bat Actuator

For terminal connections refer to Code Chart. (See Page M5-6)

SEE PAGE C43 FOR PRODUCT SPECIFICATIONS

SPDT



MTE106E

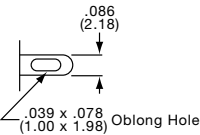
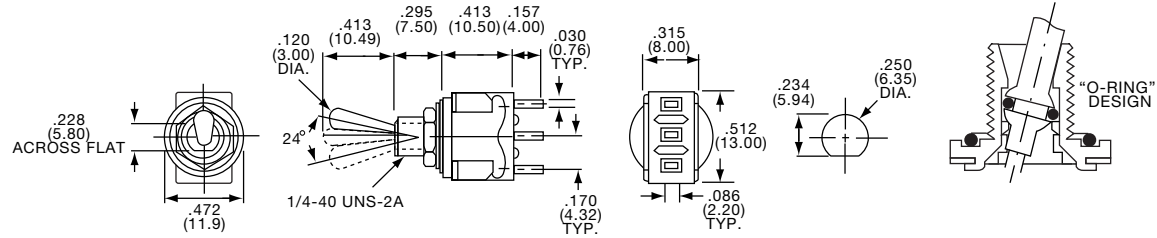

Tyco Electronics	Alcoswitch	Type	Act.	Code	P.	M5			
6-1437558-8	MTE106D	SPDT	1	On	None	On			
6-1437558-9	MTE106E	SPDT	5	On	Off	On			
7-1437558-0	MTE106F	SPDT	1	On	None	(On)			
7-1437558-1	MTE106G	SPDT	5	(On)	Off	(On)			
	MTE106H	SPDT	5	On	Off	(On)			

(On) indicates momentary position.

DPDT/SP3T



MTE206N

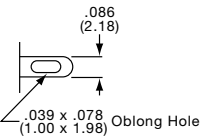
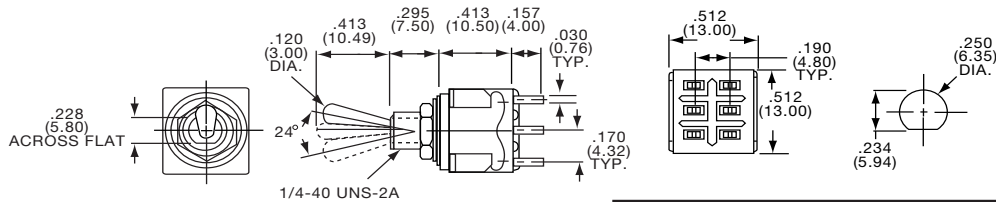

Tyco Electronics	Alcoswitch	Type	Act.	Code	P.	M5			
7-1437558-2	MTE206N	DPDT	2	On	None	On			
7-1437558-3	MTE206P	DPDT	6	On	Off	On			
7-1437558-5	MTE206R	DPDT	2	On	None	(On)			
7-1437558-6	MTE206S	DPDT	6	(On)	Off	(On)			
7-1437558-7	MTE206T	DPDT	6	On	Off	(On)			
7-1437558-4	*MTE206PA	SP3T	11	On	On	On			

(On) indicates momentary position.
*Note: PA types have case .100/(2.50) longer than other types.

3PDT



MTE306D

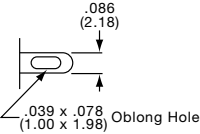
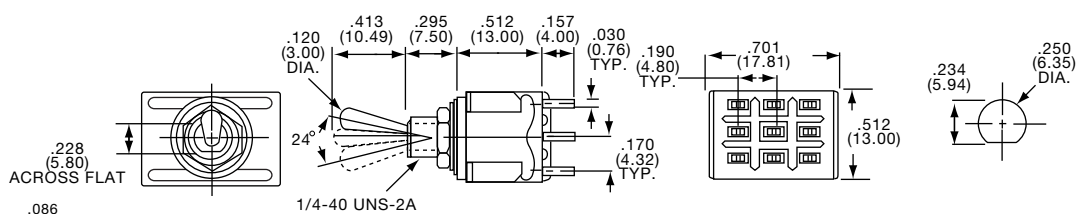

Tyco Electronics	Alcoswitch	Type	Act.	Code	P.	M5			
7-1437558-8	MTE306D	3PDT	3	On	None	On			
7-1437558-9	MTE306E	3PDT	7	On	Off	On			

4PDT



MTE406N

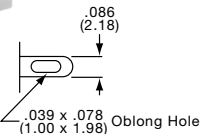
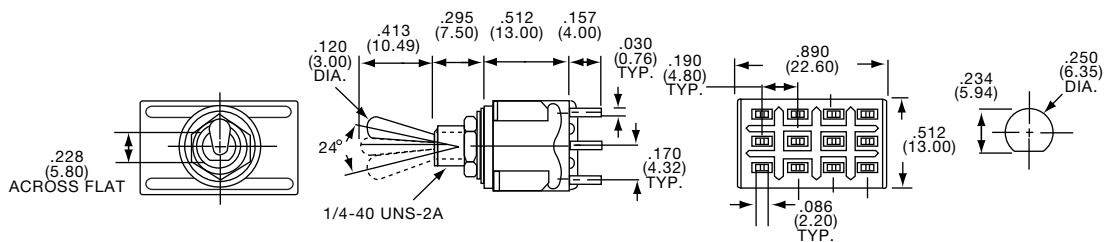

Tyco Electronics	Alcoswitch	Type	Act.	Code	P.	M5			
8-1437558-0	MTE406N	4PDT	4	On	None	On			
8-1437558-1	MTE406P	4PDT	8	On	Off	On			

Toggle Switches, MT Series, Wire Lug, Flat Actuator

SEE PAGE C43 FOR PRODUCT SPECIFICATIONS

For terminal connections refer to Code Chart. (See Page M5-6)

SPDT

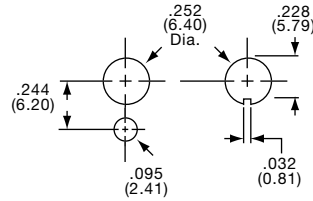
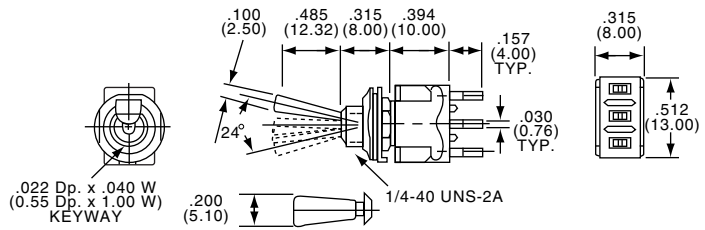

MTF106D

Satin Chrome		Bright Chrome		Type	Act. Code	P. M5	
Tyco Electronics	Alcoswitch	Tyco Electronics	Alcoswitch				
8-1437558-3	MTF106D	8-1437558-8	MTF126D	SPDT	1	On None On	
8-1437558-4	MTF106E	8-1437558-9	MTF126E	SPDT	5	On Off On	
8-1437558-5	MTF106F	9-1437558-0	MTF126F	SPDT	1	On None (On)	
8-1437558-6	MTF106G	9-1437558-1	MTF126G	SPDT	5	(On) Off (On)	
8-1437558-7	MTF106H			SPDT	5	On Off (On)	

(On) indicates momentary position.

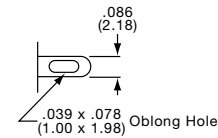

C
MTF Series

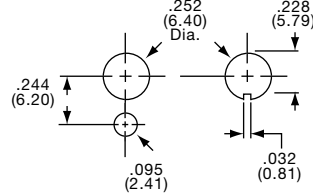
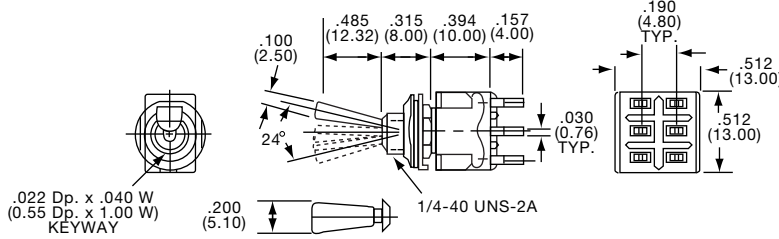

DPDT/SP3T



MTF206N

Satin Chrome		Bright Chrome		Type	Act. Code	P. M5	
Tyco Electronics	Alcoswitch	Tyco Electronics	Alcoswitch				
9-1437558-2	MTF206N	9-1437558-9	MTF226N	DPDT	2	On None On	
9-1437558-3	MTF206P	1437559-1	MTF226P	DPDT	6	On Off On	
9-1437558-5	MTF206R			DPDT	2	On None (On)	
9-1437558-6	MTF206S	1437559-4	MTF226S	DPDT	6	(On) Off (On)	
9-1437558-8	MTF206T			DPDT	6	On Off (On)	
9-1437558-4	*MTF206PA	1437559-2	*MTF226PA	SP3T	11	On On On	
9-1437558-7	*MTF206SA	1437559-5	*MTF226SA	SP3T	11	(On) On (On)	

*Note: PA & SA types have case .100/(2.50) longer than other types.

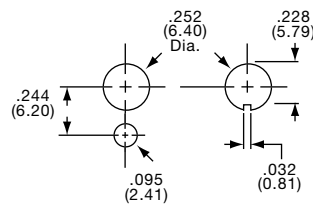
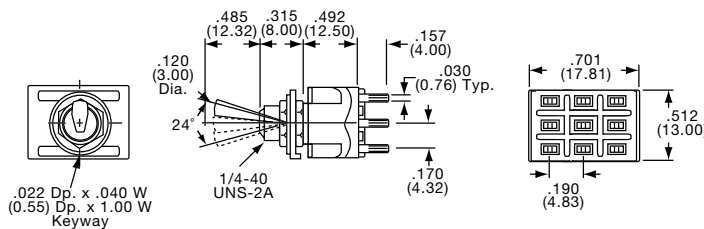
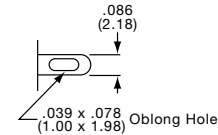

3PDT



MTF306D

Satin Chrome		Bright Chrome		Type	Act. Code	P. M5	
Tyco Electronics	Alcoswitch	Tyco Electronics	Alcoswitch				
1437559-6	MTF306D	1437559-7	MTF326D	3PDT	3	On None On	

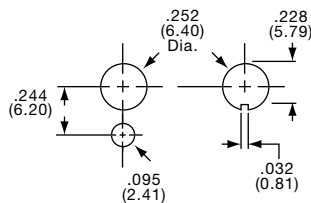
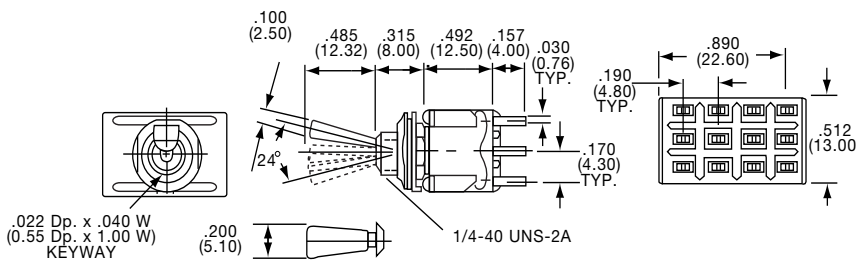
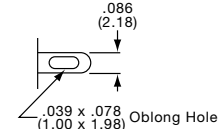

4PDT



MTF406N

Satin Chrome		Bright Chrome		Type	Act. Code	P. M5	
Tyco Electronics	Alcoswitch	Tyco Electronics	Alcoswitch				
1437559-8	MTF406N	1437559-9	MTF426N	4PDT	4	On None On	

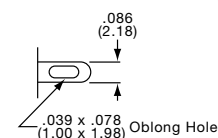

Toggle Switches, MT Series, Wire Lug, Short Mustang Actuator

For terminal connections refer to Code Chart. (See Page M5-6)

SEE PAGE C43 FOR PRODUCT SPECIFICATIONS

SPDT



MTG106D

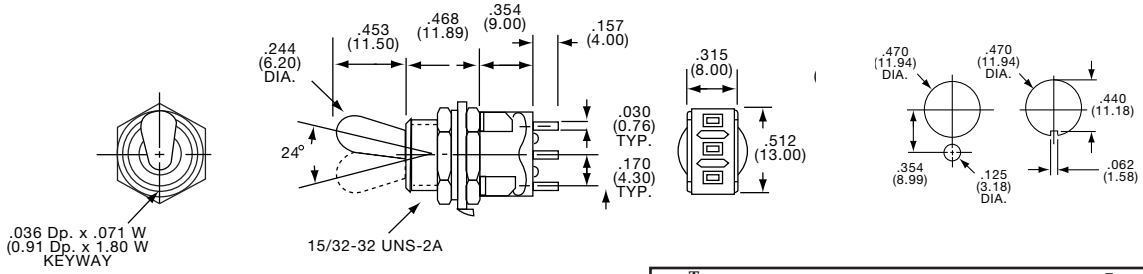

.036 Dp. x .071 W
(0.91 Dp. x 1.80 W
KEYWAY

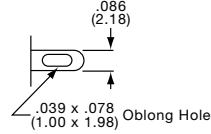

Tyco Electronics	Alcoswitch	Type	Act.	Code	P. M5	↖	↕	↗
1-1437559-1	MTG106D	SPDT	1	On	None	On		
1-1437559-2	MTG106E	SPDT	5	On	Off	On		
1-1437559-3	MTG106F	SPDT	1	On	None	(On)		
1-1437559-4	MTG106G	SPDT	5	(On)	Off	(On)		
1-1437559-5	MTG106H	SPDT	5	On	Off	(On)		

(On) indicates momentary position.

DPDT/SP3T



MTG206N

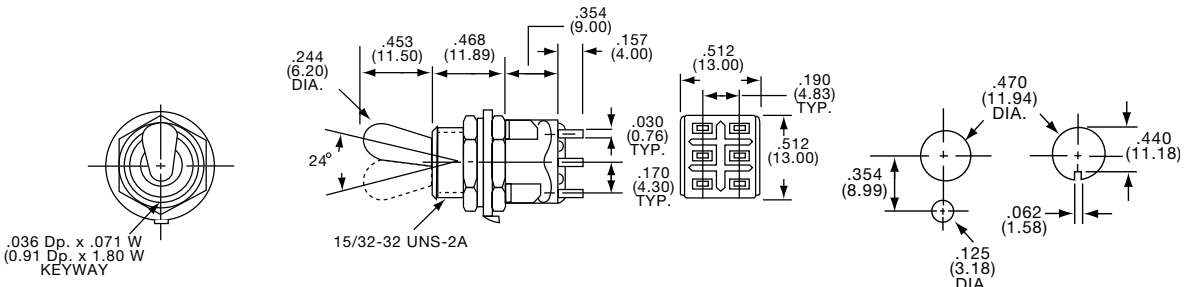

.036 Dp. x .071 W
(0.91 Dp. x 1.80 W
KEYWAY

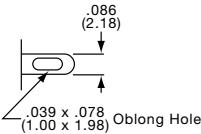

Tyco Electronics	Alcoswitch	Type	Act.	Code	P. M5	↖	↕	↗
1-1437559-8	MTG206N	DPDT	2	On	None	On		
2-1437559-0	MTG206P	DPDT	6	On	Off	On		
2-1437559-2	MTG206R	DPDT	2	On	None	(On)		
2-1437559-3	MTG206S	DPDT	2	(On)	Off	(On)		
2-1437559-4	*MTG206T	DPDT	6	On	Off	(On)		
2-1437559-1	*MTG206PA	SP3T	11	On	On	On		

(On) indicates momentary position.
*Note: PA types have case .100/(2.50) longer than other types.

3PDT



MTG306D

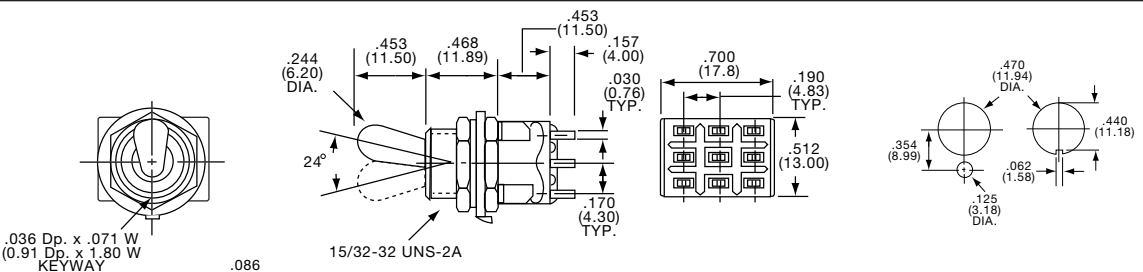

.036 Dp. x .071 W
(0.91 Dp. x 1.80 W
KEYWAY

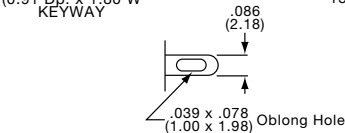

Tyco Electronics	Alcoswitch	Type	Act.	Code	P. M5	↖	↕	↗
2-1437559-8	MTG306D	3PDT	3	On	None	On		
2-1437559-9	MTG306E	3PDT	7	On	Off	On		

4PDT



MTG406N

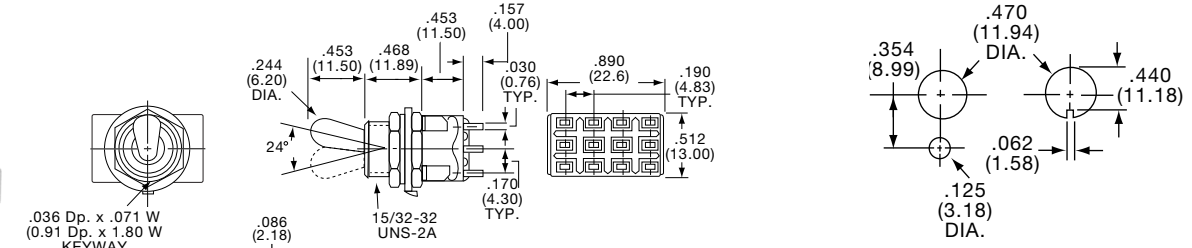

.036 Dp. x .071 W
(0.91 Dp. x 1.80 W
KEYWAY

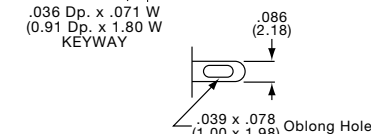

Tyco Electronics	Alcoswitch	Type	Act.	Code	P. M5	↖	↕	↗
3-1437559-1	MTG406N	4PDT	4	On	None	On		
3-1437559-2	MTG406P	4PDT	8	On	Off	On		

Toggle Switches, MT Series, Wire Lug, Long Mustang Actuator

SEE PAGE C43 FOR PRODUCT SPECIFICATIONS

For terminal connections refer to Code Chart. (See Page M5-6)

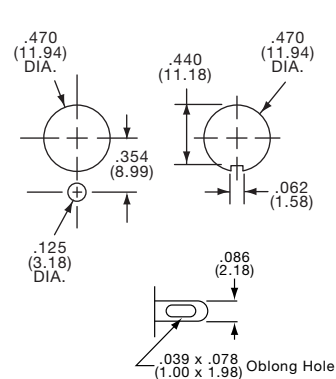
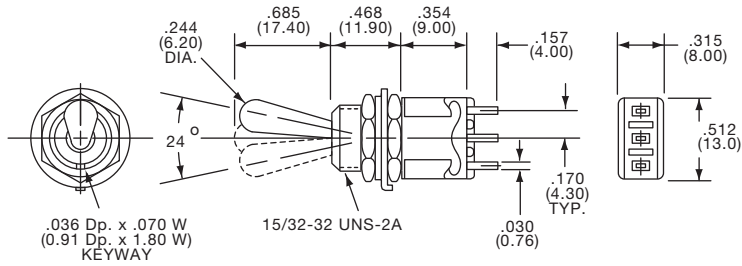

SPDT



MTG126D

Tyco Electronics	Alcoswitch	Type	Act. Code P. M5	On	None	On
1-1437559-6	MTG126D	SPDT	1	On	None	On
1-1437559-7	MTG126E	SPDT	5	On	Off	On

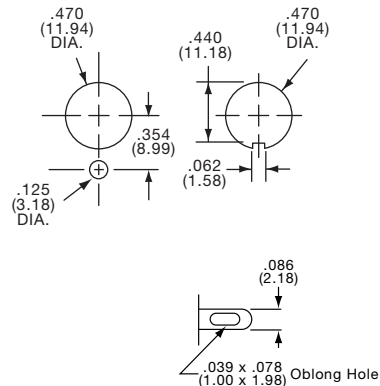
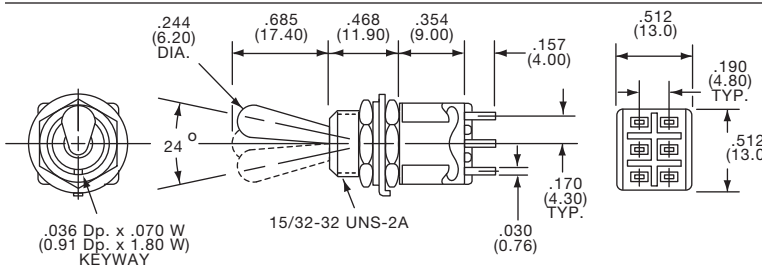

DPDT/SP3T



MTG226N

Tyco Electronics	Alcoswitch	Type	Act. Code P. M5	On	None	On
2-1437559-5	MTG226N	DPDT	2	On	None	On
2-1437559-6	MTG226P	DPDT	6	On	Off	On
2-1437559-7	*MTG226PA	SP3T	11	On	On	On

*Note: PA types have case .100/(2.50) longer than other types.

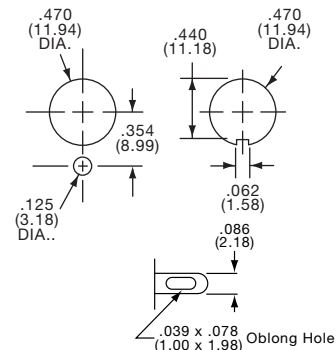
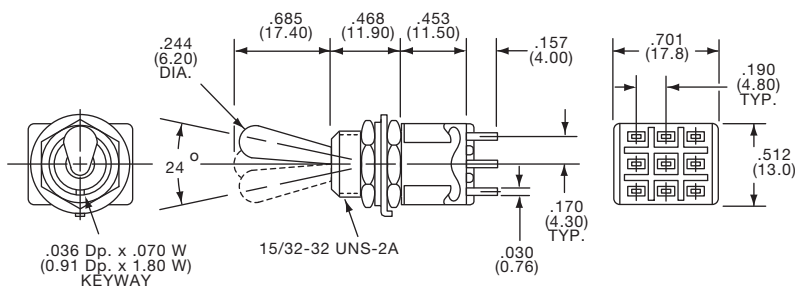

3PDT



MTG326D

Tyco Electronics	Alcoswitch	Type	Act. Code P. M5	On	None	On
3-1437559-0	MTG326D	3PDT	3	On	None	On

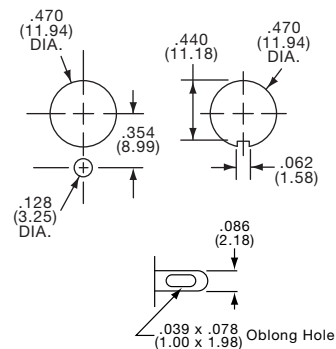
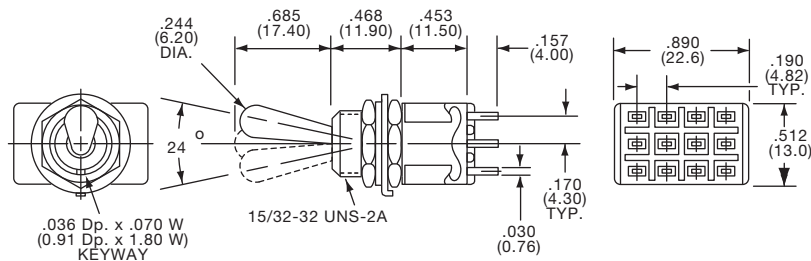

4PDT



MTG426N

Tyco Electronics	Alcoswitch	Type	Act. Code P. M5	On	None	On
3-1437559-3	MTG426N	4PDT	4	On	None	On

Toggle Switches, MT Series, Wire Lug, Miniature Locking

For terminal connections refer to Code Chart. (See Page M5-6)

SEE PAGE C43 FOR PRODUCT SPECIFICATIONS

SPDT



MTL106D

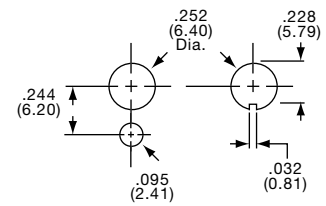
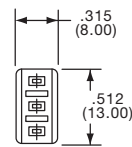
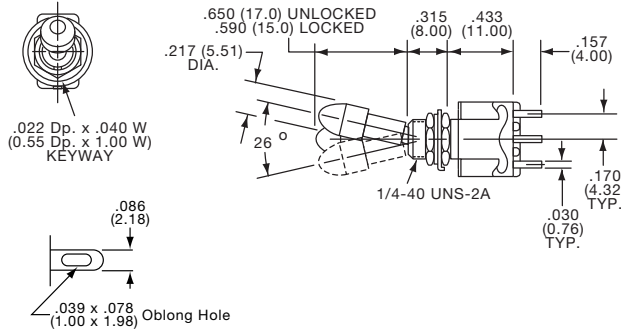

Tyco Electronics	Alcoswitch	Type	Act. Code P. M5	On	None	On
3-1437559-4	MTL106D	SPDT	1	On	None	On
3-1437559-5	MTL106E	SPDT	5	On	Off	On

DPDT/SP3T

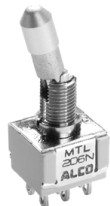

MTL206N

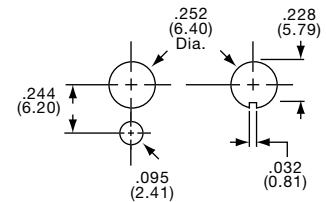
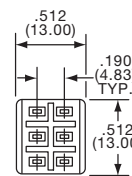
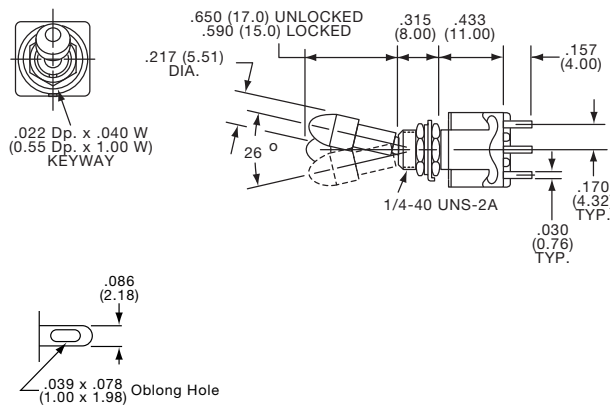

Tyco Electronics	Alcoswitch	Type	Act. Code P. M5	On	None	On
3-1437559-7	MTL206N	DPDT	2	On	None	On
3-1437559-9	MTL206P	DPDT	6	On	Off	On
4-1437559-1	MTL206S	DPDT	6	(On)	Off	(On)
4-1437559-0	*MTL206PA	SP3T	11	On	On	On

(On) indicates momentary position.
*Note: PA types have case .100/(2.50) longer than other types.

3PDT



MTL306D

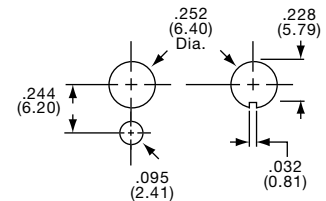
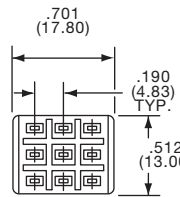
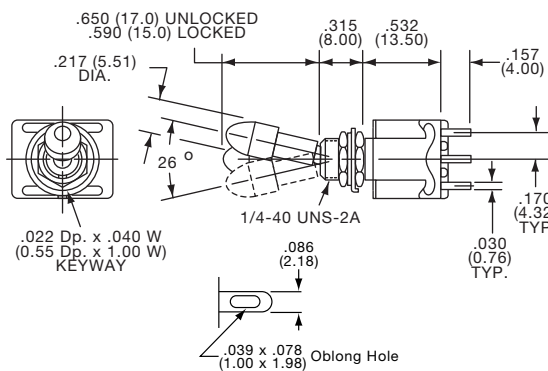

Tyco Electronics	Alcoswitch	Type	Act. Code P. M5	On	None	On
4-1437559-2	MTL306D	3PDT	3	On	None	On

4PDT/DP3T



MTL406N

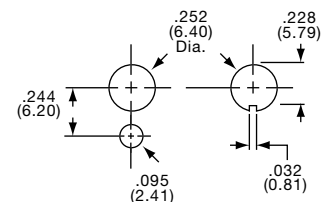
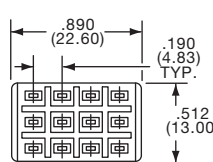
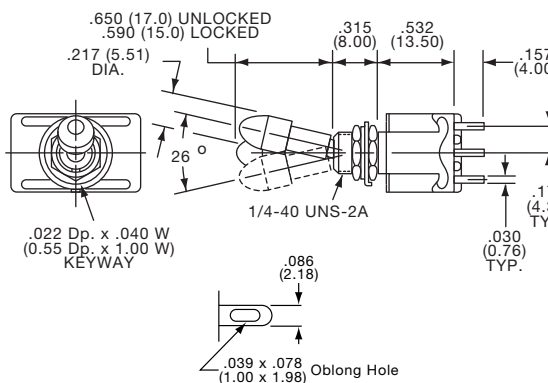

Tyco Electronics	Alcoswitch	Type	Act. Code P. M5	On	None	On
4-1437559-4	MTL406N	4PDT	4	On	None	On
4-1437559-5	*MTL406PA	DP3T	12	On	On	On

*Note: PA types have case .100/(2.50) longer than other types.

MTL Series

Toggle Switches, MT Series, PC Tail, Short Bat Actuator

SEE PAGE C43 FOR PRODUCT SPECIFICATIONS

For terminal connections refer to Code Chart. (See Page M5-6)

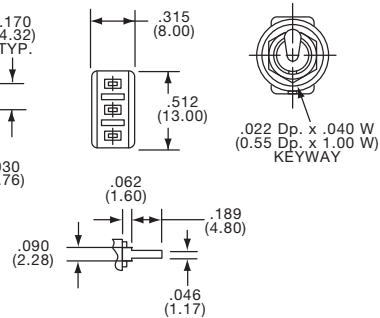
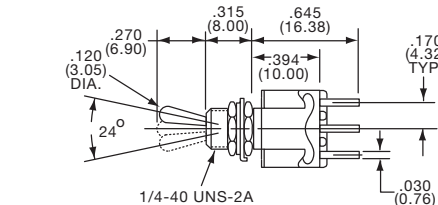
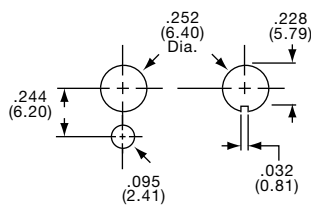

SPDT



MTM106DPC

Tyco Electronics	Alcoswitch	Type	Act. Code	P. M5	On	None	On
4-1437559-6	MTM106DPC	SPDT	1		On	None	On
4-1437559-7	MTM106EPC	SPDT	5		On	Off	On
4-1437559-8	MTM106FPC	SPDT	1		On	None	(On)

(On) indicates momentary position.

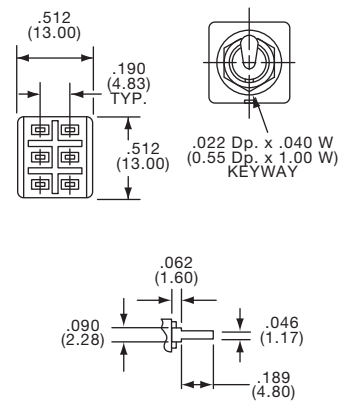
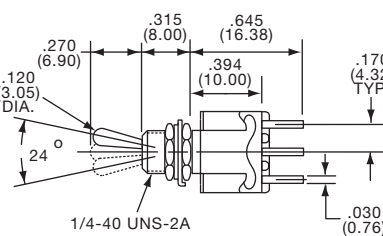
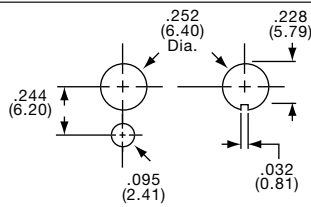

DPDT/SP3T



MTM206NPC

Tyco Electronics	Alcoswitch	Type	Act. Code	P. M5	On	None	On
4-1437559-9	MTM206NPC	DPDT	2		On	None	On
5-1437559-2	MTM206SPC	DPDT	6		(On)	Off	(On)
5-1437559-0	*MTM206PAPC	SP3T	11		On	On	On

(On) indicates momentary position.
*Note: PA types have case .100/(2.50) longer than other types.

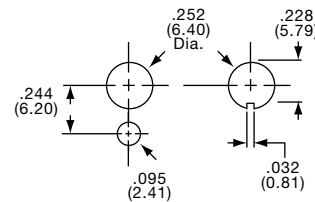
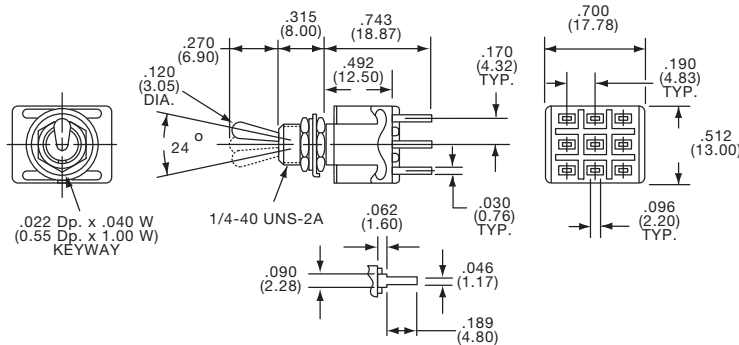

3PDT



MTM306DPC

Tyco Electronics	Alcoswitch	Type	Act. Code	P. M5	On	None	On
5-1437559-3	MTM306DPC	3PDT	3		On	None	On

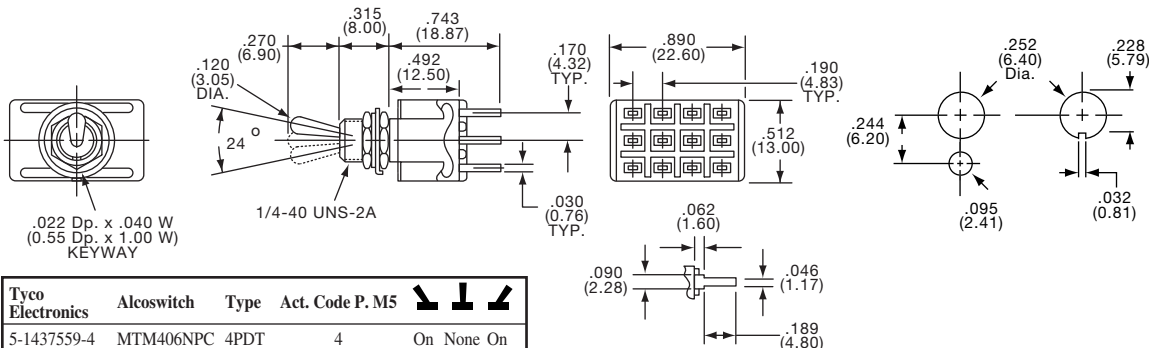

4PDT

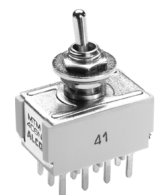

MTM406NPC

Tyco Electronics	Alcoswitch	Type	Act. Code	P. M5	On	None	On
5-1437559-4	MTM406NPC	4PDT	4		On	None	On

Toggle Switches, MT Series, Right Angle, Long or Short Bat Actuator

SEE PAGE C52 FOR PRODUCT SPECIFICATIONS

For terminal connections refer to Code Chart. (See Page M5-6)

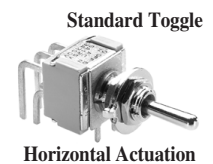
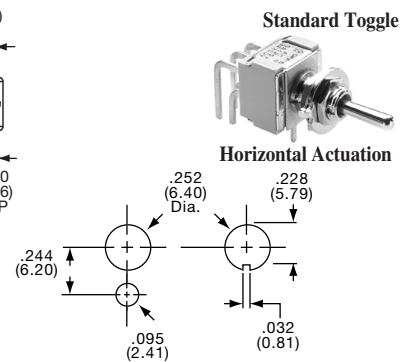
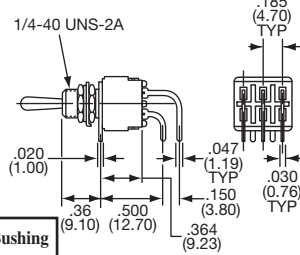
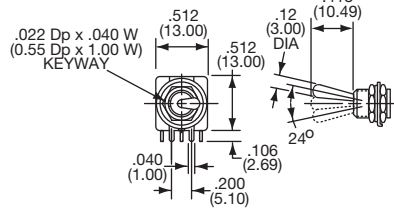
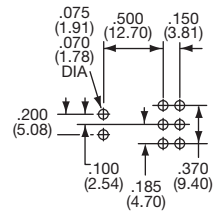

Horizontal Actuation

Tyco Electronics	Alcoswitch	Type	Act. Code	P. M5	Toggle	Bushing
5-1437558-6	MTA8206NRA	DPDT	2	On None On	.410	1/4-40
5-1437558-9	MTA8206PRA	DPDT	6	On Off On	.410	1/4-40
	MTA8206RRA	DPDT	2	(On) None (On)	.410	1/4-40

(On) indicates momentary position.

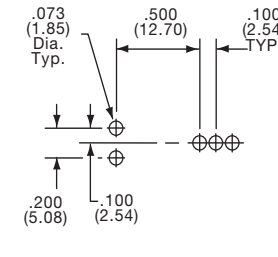
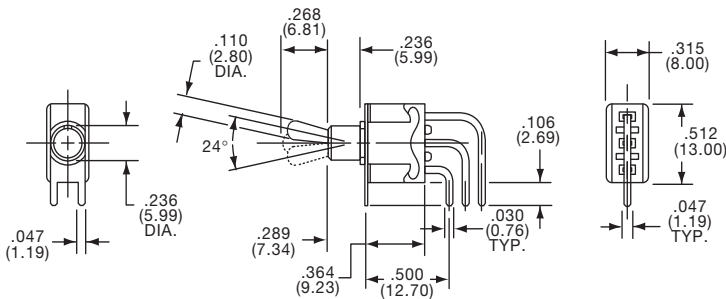

MTM8106DVRA Vertical Actuation

Tyco Electronics	Alcoswitch	Type	Act. Code	P. M5	Short Toggle	Bushing
5-1437559-7	MTM8106DVRA	SPDT	1	On None On	.270	.250
5-1437559-9	MTM8106EVRA	SPDT	5	On Off On	.270	.250

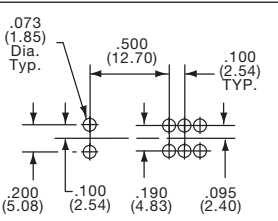
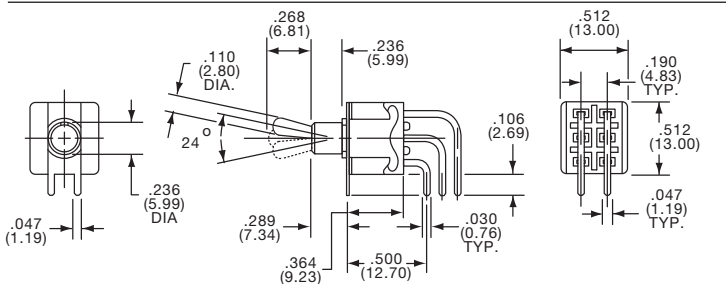

MTM8206NVRA Vertical Actuation

Tyco Electronics	Alcoswitch	Type	Act. Code	P. M5	Short Toggle	Bushing
1417566-1	MTM8206NVRA	DPDT	1	On None On	.270	.250
	MTM8206PVRA	DPDT	5	On Off On	.270	.250
147673-2	MTM8206RVRA	DPDT	1	On None (On)	.270	.250

(On) indicates momentary position.

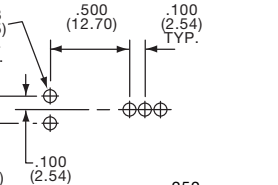
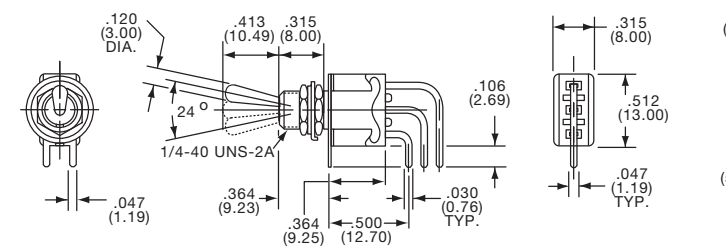

MTA8106DVRA Vertical Actuation

Tyco Electronics	Alcoswitch	Type	Act. Code	P. M5	Short Toggle	Bushing
5-1437558-1	MTA8106DVRA	SPDT	1	On None On	.410	1/4-40
147676-1	MTA8106EVRA	SPDT	5	On Off On	.410	1/4-40
	MTA8106FVRA	SPDT	1	On None (On)	.410	1/4-40

(On) indicates momentary position.

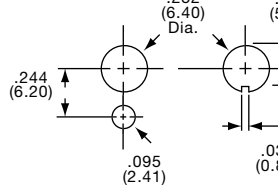

Toggle Switches, MT Series, Right Angle, Long or Short Bat Actuator

SEE PAGE C52 FOR PRODUCT SPECIFICATIONS

DPDT



MTA8206NVRA
Vertical Actuation

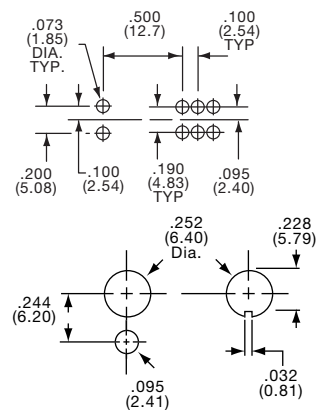
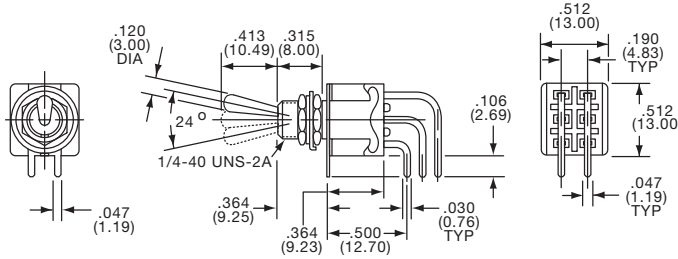

Tyco Electronics	Alcoswitch	Type	Act. Code	P. M5	On	None	Off	Short Toggle	Bushing
5-1437558-7	MTA8206NVRA	DPDT	1		On	None	On	.410	1/4-40
6-1437558-0	MTA8206PVRA	DPST	5		On	Off	On	.410	1/4-40

Toggle Switches, Hardware and Accessories

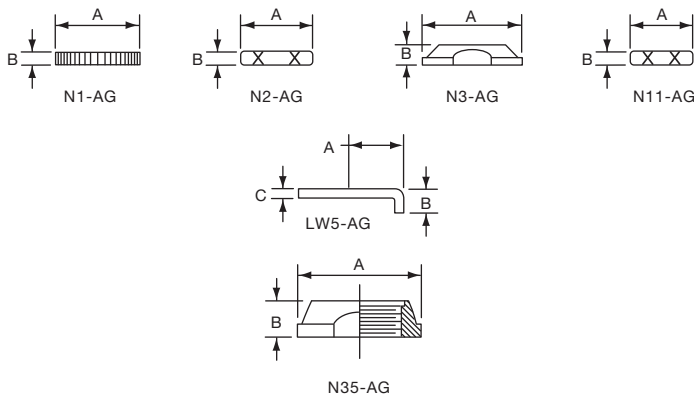

STANDARD AND DECORATIVE MOUNTING HARDWARE

Fits all miniature toggle and pushbutton switches with 1/4-40 bushings. N1 and N3 nuts are recommended as styling options.



Tyco Electronics	Alcoswitch	Description	Diameter	Finish	A	Dim. B	C
1437628-7	N1-AG	Knurled Nut	1/4-40	Bright Nickel	.350	.060	
1437561-9	10264-00-120	Hex Nut	1/4-40	Bright Nickel	.312	.062	
1-1437628-3	N3-AG	Dress Nut	1/4-40	Bright Nickel	.460	.090	
1-1437561-2	11106-AG	Hex Nut	10-48	Bright Nickel	.281	.047	
1-1437628-4	N35-AG	Dress Nut	15/32-32	Chrome Plate	.630	.170	
1437628-2	LW1	Int. Tooth Lock Washer	1/4-40	Bright Nickel	.406	.024	
1437628-5	LW5-AG	Locking Ring	1/4"	Bright Nickel	.200	.086	.032
1437628-3	LW12-AG	Lock Washer	No. 10	Bright Nickel	.315	.035	.035

"PERFECT FIT" DECORATIVE MOUNTING HARDWARE

Use blind threaded nuts for ultimate appearance. Finger tighten until nut rests on ridge - Final tightening with back-up nut.

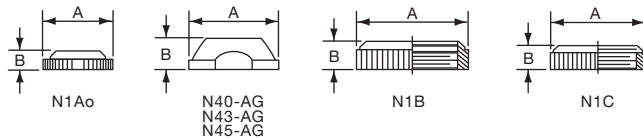

Tyco Electronics	Alcoswitch	Description	Diameter	Finish	Dim. A	Dim. B
1437628-9	N1A	Knurled Nut	1/4-40	Chrome Plate	.315	.080
1-1437628-0	N1B	Knurled Nut	15/32-32	Bright Nickel	.562	.140
1-1437628-1	N1C	Knurled Nut	3/8-32	Bright Nickel	.469	.093
1-1437628-5	N40-AG	Dress Nut	1/4-40	Matte Nickel	.375	.120
1-1437628-6	N43-AG	Dress Nut	1/4-40	Bright Nickel	.375	.120
1-1437628-7	N45-AG	Dress Nut	15/32-32	Chrome Plate	.630	.170





Toggle Switches, Legend Plates, Boot Seals

Constructed of .025 gauge brushed aluminum, finished with scratch resistant matte black enamel. Easily readable & aesthetically attractive.

Tyco Electronics	Alcoswitch	Description	Dim.	
			A	B
2-1437628-4	SPA32	On-Off (for 1/4" diameter switch)	.375	.880
2-1437628-6	SPA42	On-Off (for 15/32" diameter switch)	.680	1.125

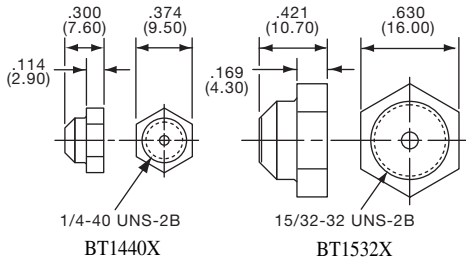

1/4-40 & 15/32-32 TOGGLE SWITCH BOOT SEALS

Splashproof seals especially designed for toggle switches having longer actuators. They are also highly recommended for 3-position maintained toggle switches where full-cover boots may have a tendency to pull the toggle back to center. No O-Ring required. These boot seals are not recommended for use with flat toggles.



BT1440

Tyco Electronics	Alcoswitch	Mount Color	Boot Color	Thread Size	Use With Switch Type
3-1437626-6	BT14400	Black	Black	1/4-40	TT, MTA, Gemini
	BT14402	Red	Red	1/4-40	TT, MTA, Gemini
	BT14408	Gray	Gray	1/4-40	TT, MTA, Gemini
3-1437626-7	BT15320	Black	Black	15/32-32	MTG Series
3-1437626-8	BT15322	Red	Red	15/32-32	MTG Series
3-1437626-9	BT15328	Gray	Gray	15/32-32	MTG Series

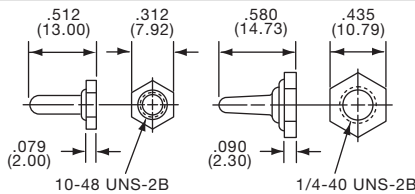

10-48 & 1/4-40 TOGGLE SWITCH BOOT SEALS

Splashproof seals designed for "TINY" and miniature switches with bat toggles up to .370" long. A hex nut is integrally bonded to the Neoprene boot. No O-Ring is required.



B14400

B10480

Tyco Electronics	Alcoswitch	Mount Color	Boot Color	Thread Size	Use With Switch Type
1437626-1	B10480	Black	Black	10-48	TT Series
1437626-2	B10482	Red	Red	10-48	TT Series
1437626-3	B10488	Gray	Gray	10-48	TT Series
1437626-4	B14400	Black	Black	1/4-40	TT, MTA, Gemini
1437626-5	B14402	Red	Red	1/4-40	TT, MTA, Gemini
1437626-6	B14408	Gray	Gray	1/4-40	TT, MTA, Gemini

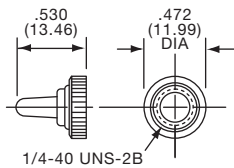

1/4-40 TOGGLE SWITCH BOOT SEALS

Splashproof toggle seals having 1/4-40 blind nuts integrally mounted on the Black Neoprene seal. Supplied with captive O-Ring to complete the panel seal. Accepts bat toggles from .375" to .468" long.

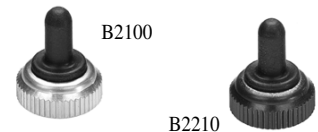

B2100

B2210

Tyco Electronics	Alcoswitch	Mount Color	Boot Color	Thread Size	Use With Switch Type
1-1437626-0	B2100	Nickel	Black	1/4-40	TT, Gemini and MTA Series
1-1437626-1	B2210	Black	Black	1/4-40	TT, Gemini and MTA Series

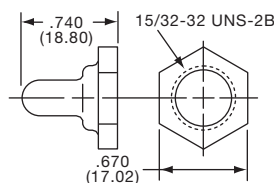

15/32-32 TOGGLE SWITCH BOOT SEALS

Splashproof toggle seals incorporating a molded-in hex nut for water tight & dust tight protection. Recommended for standard size toggle switches with short to medium length toggle levers. Replaces standard hardware usually supplied with the switch.



B15320

Tyco Electronics	Alcoswitch	Mount Color	Boot Color	Thread Type	Use With Switch Type
1437626-7	B15320	Black	Black	15/32-32	MTG Series, Gemini "T", "T1" Options
1437626-8	B15322	Red	Red	15/32-32	MTG Series, Gemini "T", "T1" Options
1437626-9	B15328	Gray	Gray	15/32-32	MTG Series, Gemini "T", "T1" Options

Engineering Notes



Engineering Notes