



FEATURES

- PLASTIC PACKAGE HAS UNDERWRITERS LABORATORY FLAMMABILITY CLASSIFICATION 94V-0
- ULTRA FAST RECOVERY TIMES FOR HIGH EFFICIENCY
- LOW FORWARD VOLTAGE, HIGH CURRENT CAPABILITY
- LOW LEAKAGE
- HIGH SURGE CAPABILITY
- HIGH TEMPERATURE SOLDERING GUARANTEED:
260°C 0.375" (9.5mm) LEAD LENGTHS FOR 10 SECONDS AT 5 LBS.(2.3KG)TENSION

Mechanical Data

- CASE: MOLDED PLASTIC, DO41, DIMENSIONS IN INCHES AND (MILLIMETERS)
- TERMINALS: AXIAL LEADS SOLDERABLE PER MIL-STD-202, METHOD 208
- POLARITY: COLOR BAND DENOTES CATHODE END
- MOUNTING POSITION: ANY
- WEIGHT: 0.34 GRAMS

DO-27

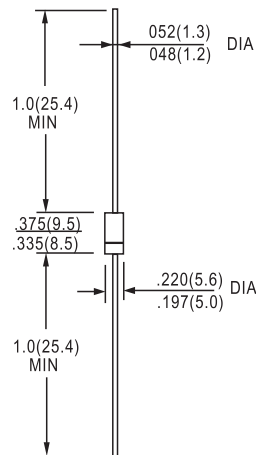

Dimensions in inches and (millimeters)

MAXIMUM RATINGS AND ELECTRICAL CHARACTERISTICS

Maximum Ratings

		FUF 5400	FUF 5401	FUF 5402	FUF 5404	FUF 5406	FUF 5407	FUF 5408	
V_{RRM}	Peak Recurrent reverse voltage (V)	50	100	200	400	600	800	1000	
V_{RMS}	Maximum RMS voltage	35	70	140	280	420	560	700	
V_{DC}	Maximum DC blocking voltage	50	100	200	400	600	800	1000	
$I_{F(AV)}$	Forward current at $T_{amb} = 55^{\circ}C$	3 A							
I_{FRM}	Recurrent peak forward surge current	30 A							
I_{FSM}	8.3 ms. peak forward surge current (Jedec Method)	150 A							
t_{tr}	Max. reverse recovery time from $I_F = 0.5 A$; $I_R = 1 A$; $I_{RR} = 0.25 A$	50 ns				75 ns			
C_j	Typical Junction Capacitance at 1 MHz and reverse voltage of $4V_{DC}$	45 pF							
T_j	Operating temperature range	- 65 to + 150 °C							
T_{stg}	Storage temperature range	- 65 to + 150 °C							
E_{RSM}	Maximum non repetitive peak reverse avalanche energy. $I_R = 1 A$; $T_J = 25^{\circ}C$	20 mJ							

Electrical Characteristics at $T_{amb} = 25^{\circ}C$

V_F	Max. forward voltage drop at $I_F = 3 A$	1.3 V	1.7 V
I_R	Max. reverse current at V_{RRM} at $25^{\circ}C$	5 μA	
R_{thj-a}	Max. thermal resistance ($l = 10 mm.$)	30 °C/W	



RATINGS AND CHARACTERISTIC CURVES FUF5400 THRU FUF5408

FIG. 1-TEST CIRCUIT DIAGRAM AND REVERSE RECOVERY TIME CHARACTERISTIC

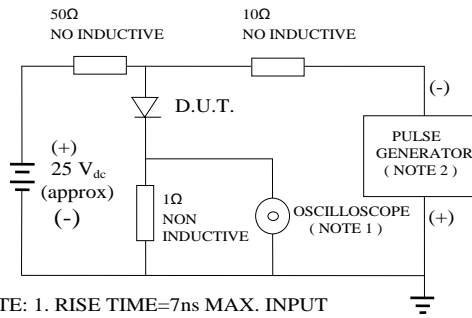

NOTE: 1. RISE TIME=7ns MAX. INPUT IMPEDANCE=1 MOhms 22PF
 2. RISE TIME =10ns MAX. SOURCE IMPEDANCE=50 OHMS

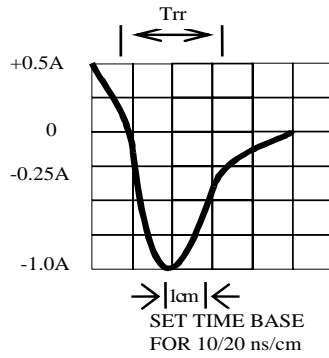

FIG. 2 -TYPICAL FORWARD CURRENT DERATING CURVE

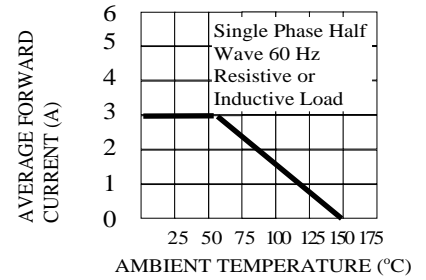

FIG. 3 -TYPICAL REVERSE CHARACTERISTICS

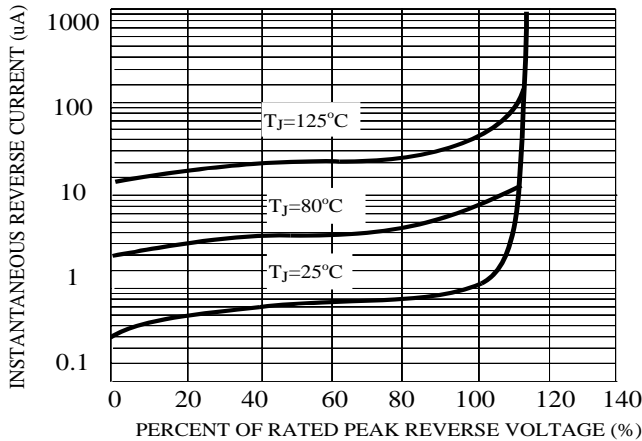

FIG. 4 -TYPICAL INSTANTANEOUS FORWARD CHARACTERISTICS

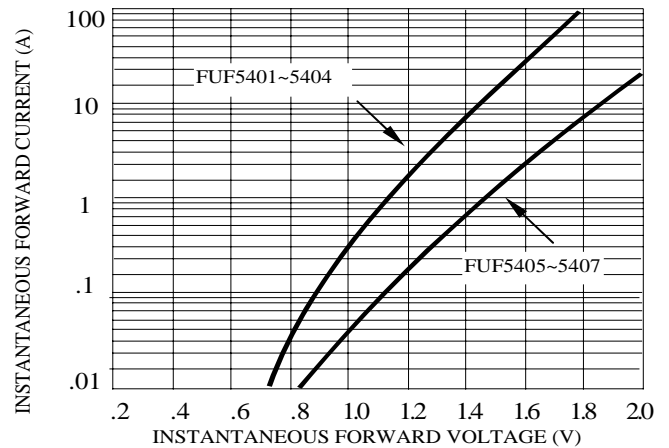

FIG. 5 -MAXIMUM NON-REPETITIVE FORWARD SURGE CURRENT

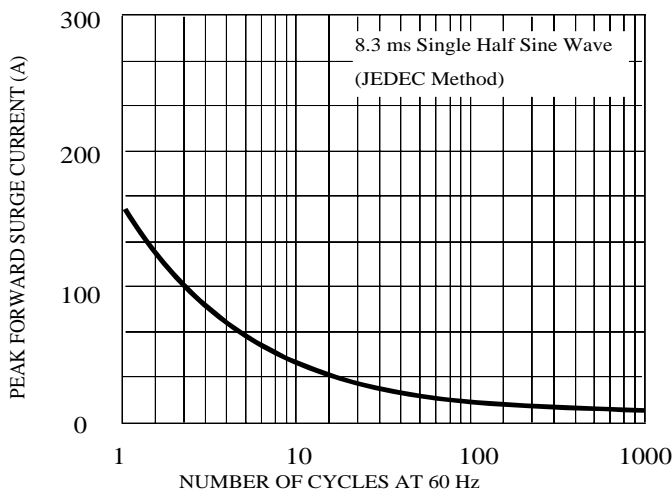

FIG. 6 -TYPICAL JUNCTION CAPACITANCE

