

### Metal Oxide Varistors Data Sheet

#### Features

- TMOV integrated thermal protection device
- High peak surge current rating up to 6KA
- Designed to facilitate compliance to UL1449 for TVSS products
- Wide operating voltage (V1mA) range from 82V to 1200V
- Rated current: 5A
- Rated Functioning Temperature:136(°C)
- Fast responding to transient over-voltage and limited current
- Large absorbing transient energy capability
- Low clamping ratio and no follow-on current
- Meets MSL level 1, per J-STD-020
- Operating Temperature : -40°C ~ +85°C
- Storage Temperature : -40°C ~ +85°C



#### Applications

- AC power line or AC/DC supplies
- Transistor, diode, IC, thyristor or triac semiconductor protection
- Surge protection in consumer electronics
- Surge protection in industrial electronics
- Surge protection in electronic home appliances, gas and petroleum appliances
- AC panel protection Modules

#### Description of Part Number

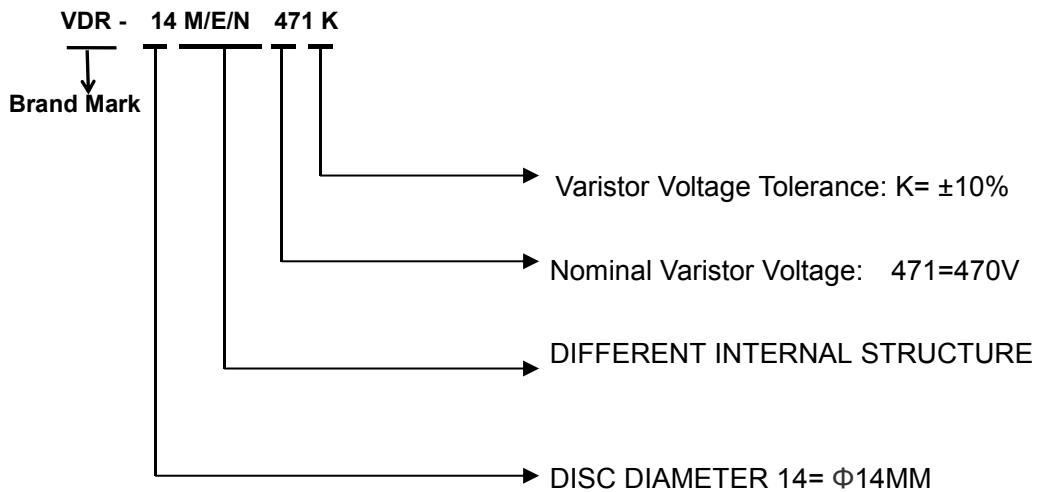

#### Delivery Time

Standard MOV	Delivery Time
VDR-14M/E/N820K ~ VDR-14M/E/N122K	24days

### Lead configurations and application examples

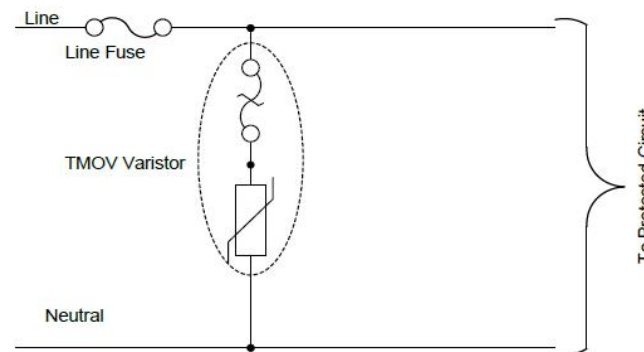
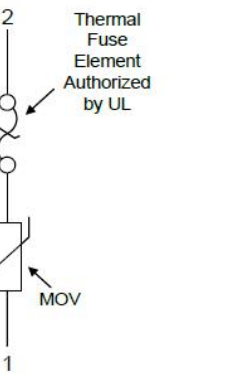
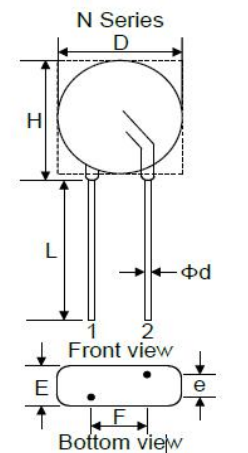
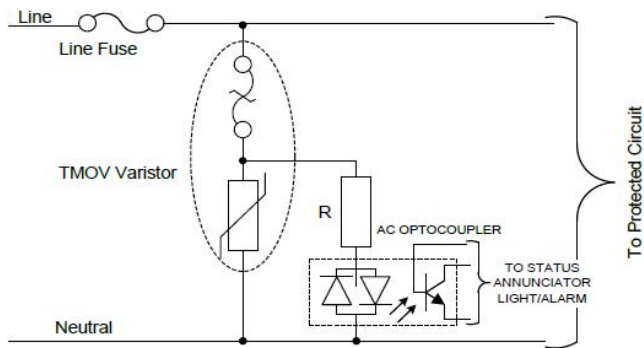
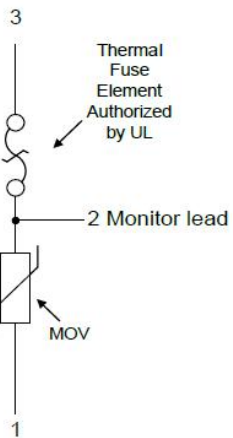
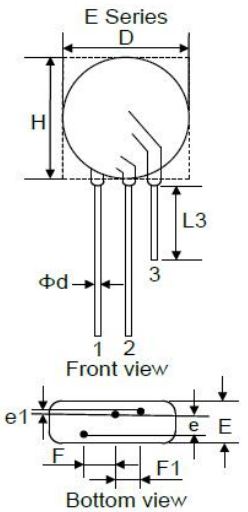
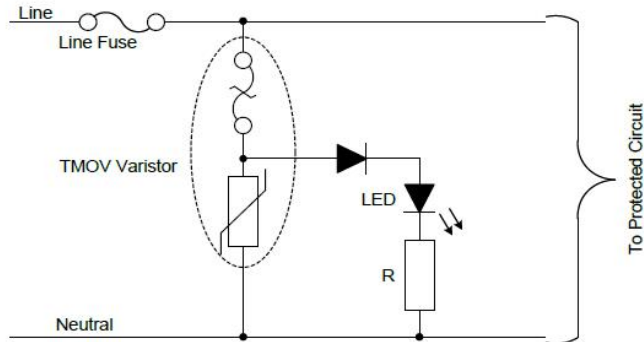
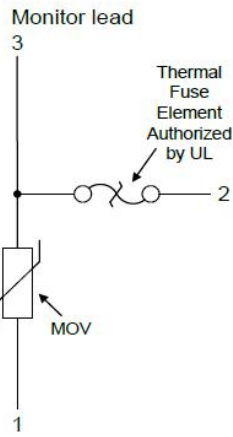
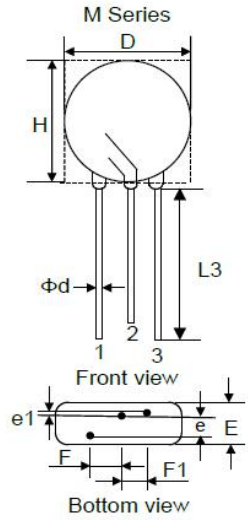

Dimension

Symbol		HUAAN'S M / E/ N Varistor			Unit: mm
		14M	14E	14N	
D(Max)		19.0mm	19.0mm	19.0mm	
H(Max)		21.0mm	21.0mm	21.0mm	
F(±1.0)		7.5mm	7.5mm	7.5mm	
F1(±1.0)		5.0mm	5.0mm	--	
e(Max)	820K ~ 121K	2.8mm	2.8mm	2.8mm	
	151K ~ 391K	3.8mm	3.8mm	3.8mm	
	431K ~ 621K	5.5mm	5.5mm	5.5mm	
	681K ~ 911K	7.8mm	7.8mm	7.8mm	
	102K ~ 122K	10.0mm	10.0mm	10.0mm	
e1(Max)	820K ~ 121K	1.3±0.8mm	1.3±0.8mm	--	
	151K ~ 391K				
	431K ~ 621K				
	681K ~ 911K				
	102K ~ 122K				
E(Max)	820K ~ 121K	8.8mm	8.8mm	8.8mm	
	151K ~ 391K	9.8mm	9.8mm	9.8mm	
	431K ~ 621K	11.5mm	11.5mm	11.5mm	
	681K ~ 911K	13.8mm	13.8mm	13.8mm	
	102K ~ 122K	16.0mm	16.0mm	16.0mm	
L(Min)		20.0mm	20.0mm	20.0mm	
L3(Min)		10.0mm	10.0mm	--	
Φd		0.8mm			

Electrical Characteristics



Part Number	Maximum Allowable Voltage		Varistor Voltage V <sub>1mA</sub> (V)	Maximum Clamping Voltage V <sub>c</sub> (V) AT 50A	Max Surge Current I <sub>s</sub> /20μs		Maximum Energy E <sub>10/1000μs</sub>		Rated Power W	Typical Capacitance (Reference) @1KHz(pf)
	V <sub>AC</sub> (V)	V <sub>DC</sub> (V)			1time	2times	10/1000μs	2ms		
	14M/E/N820K	50	65	82(73.8~90.2)	135	4500A	2500A	27J	22J	0.6
14M/E/N101K	60	85	100(90~110)	165	4500A	2500A	33J	28J	0.6	2000
14M/E/N121K	75	100	120(108~132)	200	4500A	2500A	40J	32J	0.6	1700
14M/E/N151K	95	125	150(135~165)	250	6000A	4500A	50J	40J	0.6	1300
14M/E/N181K	115	150	180(162~198)	300	6000A	4500A	58J	50J	0.6	1100
14M/E/N201K	130	170	200(180~220)	340	6000A	4500A	70J	57J	0.6	1000
14M/E/N221K	140	180	220(198~242)	360	6000A	4500A	78J	60J	0.6	900
14M/E/N241K	150	200	240(216~264)	395	6000A	4500A	85J	63J	0.6	830
14M/E/N271K	175	225	270(243~297)	455	6000A	4500A	100J	70J	0.6	740
14M/E/N301K	190	250	300(270~330)	500	6000A	4500A	107J	77J	0.6	670
14M/E/N331K	210	275	330(297~363)	550	6000A	4500A	115J	85J	0.6	610
14M/E/N361K	230	300	360(324~396)	595	6000A	4500A	125J	93J	0.6	560
14M/E/N391K	250	320	390(351~429)	650	6000A	4500A	140J	100J	0.6	510
14M/E/N431K	275	350	430(387~473)	710	6000A	4500A	155J	115J	0.6	460
14M/E/N471K	300	385	470(423~517)	775	6000A	4500A	175J	125J	0.6	430
14M/E/N511K	320	415	510(459~561)	845	6000A	4500A	190J	125J	0.6	390
14M/E/N561K	350	460	560(504~616)	925	6000A	4500A	200J	125J	0.6	360
14M/E/N621K	385	505	620(558~682)	1025	6000A	4500A	210J	125J	0.6	320
14M/E/N681K	420	560	680(612~748)	1120	6000A	4500A	220J	130J	0.6	290
14M/E/N751K	460	615	750(675~825)	1240	6000A	4500A	225J	143J	0.6	270
14M/E/N781K	485	640	780(702~858)	1290	6000A	4500A	240J	148J	0.6	260
14M/E/N821K	510	670	820(738~902)	1355	6000A	4500A	245J	157J	0.6	240
14M/E/N911K	550	745	910(819~1001)	1500	6000A	4500A	255J	175J	0.6	220
14M/E/N102K	625	825	1000(900~1100)	1650	6000A	4500A	280J	190J	0.6	200
14M/E/N112K	680	895	1100(990~1210)	1815	6000A	4500A	310J	205J	0.6	180
14M/E/N122K	750	990	1200(1080~1320)	1980	6000A	4500A	338J	215J	0.6	150

Packing Information

Part Number	Quantity	Packaging Option	Packaging Specification
14M/E/NxxxK	200PCS	Plastic bag	Bulk Pack

