

Helping Customers Innovate, Improve & Grow



Description

Vectron's VT-803 Temperature Compensated Crystal Oscillator (TCXO) is a quartz stabilized, clipped sine wave or CMOS output, 5th order analog temperature compensated oscillator, operating off a 2.8 to 5.0 volt supply in a hermetically sealed 5x3.2 mm ceramic package.

Features

- Clipped Sine Wave or CMOS Output
- 10.000-52.000 MHz Output
- ± 100 ppb Temperature Stability
- Optional Enable/Disable Function
- Optional VCXO
- Fundamental Crystal Design
- Gold over nickel contact pads
- Hermetically Sealed Ceramic 5x3.2 SMD package
- Product is compliant to RoHS directive  and fully compatible with lead free assembly

Applications

- Stratum 3
- SyncE
- 1588
- Femto Cells
- Base Stations
- IP Networking
- GPS
- Point to Point Radio
- Manpack Radio
- Test and Measurement

Block Diagram

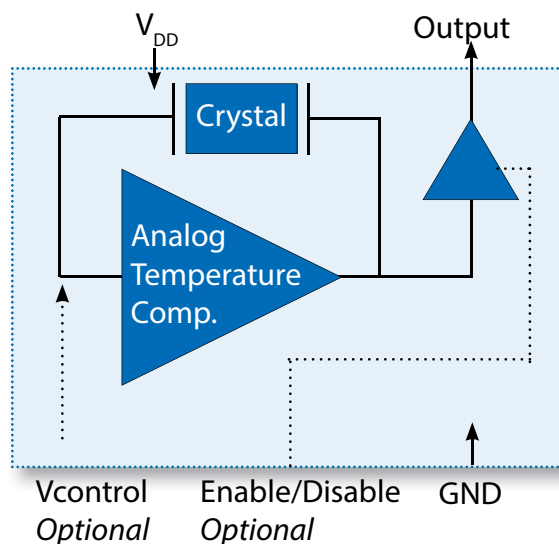

Specifications

Table 1. Electrical Performance, Clipped Sine Wave Option

| Parameter | Symbol | Min | Typ | Max | Units |
|----------------------------------------------------------------------------|-----------|--------------------------------------------|------|----------------|------------|
| Output Frequency, ¹ <i>Ordering Option</i> | f_o | 10 | | 52 | MHz |
| Supply Voltage ² , <i>Ordering Option</i> | V_{DD} | +2.8, +3.0, +3.3, +5.0 | | | V |
| Supply Current, 10-20.000MHz 20.001-52.000MHz | I_{DD} | | | 2.0 3.4 | mA |
| Operating Temperature, <i>Ordering Option</i> | T_{OP} | -20/70, -40/85 | | | °C |
| Stability Over Operating Temperature ³ , <i>Ordering Option</i> | | $\pm 0.100, \pm 0.200, \pm 0.280, \pm 1.0$ | | | ppm |
| Initial Accuracy, "No Adjust" Option ⁴ | | | | ± 1.5 | ppm |
| Power Supply Stability, $\pm 5\%$ change | | | | ± 0.05 | ppm |
| Load Stability, $\pm 10\%$ change | | | | ± 0.05 | ppm |
| Aging | | | | ± 0.5 | ppm 1st yr |
| Stability, temperature and 24 hours ⁵ | | | | ± 0.37 | ppm |
| Total Stability ⁵ | | | | ± 4.6 | ppm |
| Pull Range, <i>Ordering Option</i> | PR | $\pm 5, \pm 10$ | | | ppm |
| Control Voltage to reach Pull Range | | 0.5 | | 2.5 | V |
| Control Voltage Impedance | | 100 | | | Kohm |
| Output Enable/Disable ⁶ , <i>Ordering Option</i> | | | | $0.8 * V_{DD}$ | V |
| Output Enabled | V_{IH} | | | | V |
| Output Disabled (high impedance output) | V_{IL} | $0.2 * V_{DD}$ | | | V |
| Output Level | V_o p/p | 0.8 | | | V |
| Output Load | | | | 10K 10pF | |
| Phase Noise, 26.000MHz | ϕ_N | | | | dBc/Hz |
| 10Hz | | | -91 | | |
| 100Hz | | | -117 | | |
| 1kHz | | | -136 | | |
| 10kHz | | | -150 | | |
| 100kHz | | | -158 | | |
| Start Up Time | t_{SU} | | | 2 | ms |

- The Output is DC coupled.
- The VT-803 power supply pin should be filtered, eg, a 10uF, 0.1uF and 0.01uf capacitor.
- Not all stabilities are available over all temperature ranges. Measured at mid Vc for parts with frequency tuning.
- After 2 IR reflows and 24 hours.
- $\pm 100, \pm 200$ and ± 280 ppb temp stability parts, all inclusive with 10 years aging.
- Output is Enabled if E/D is left open.

Outline Drawing

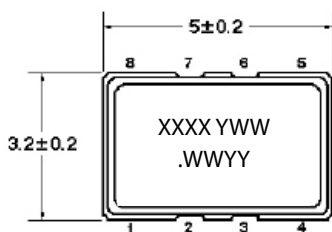

Dimensions in mm

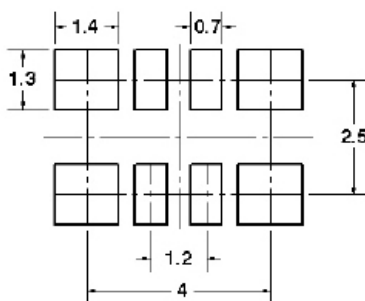
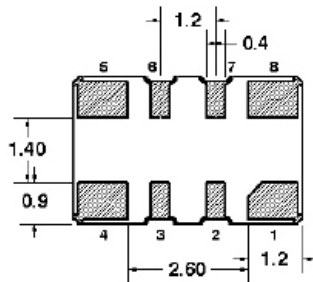

Marking

XXXX = Frequency (2500 = 25M000)
 YWW = Crystal Date Code
 .WWYY = TCXO Date Code

Table 2. Pinout

| Pin # | Symbol | Function |
|-------|-------------|---------------------------------------|
| 1 | NC or V_C | No Connection or TCXO Control Voltage |
| 2 | NC | Make No Connection |
| 3 | NC | Make No Connection |
| 4 | GND | Ground |
| 5 | OUT | Output |
| 6 | NC or E/D | No Connection or Enable/Disable |
| 7 | NC | Make No Connection |
| 8 | V_{DD} | Supply Voltage |

Table 3. Enable Disable Function (optional)

| Pin 6 | Pin 5 Output |
|-------|----------------|
| High | Clock Output |
| Open | Clock Output |
| Low | High Impedance |

Specifications

| Table 4. Electrical Performance, CMOS Option | | | | | |
|------------------------------------------------------------------------------------------------------------------------------------------------------|----------------------|------------------------------|-------------------------------------|----------------------------------|--------------------|
| Parameter | | Min | Typ | Max | Units |
| Output Frequency ¹ , <i>Ordering Option</i> | f_o | 10 | | 52 | MHz |
| Supply Voltage ² , <i>Ordering Option</i> | V_{DD} | +2.8, +3.0, +3.3, +5.0 | | | V |
| Supply Current, 10-24.999MHz 25.000-39.000MHz 40.000- 49.999MHz 50.000- 52.000MHz | I_{DD} | | | 3.0 3.5 5.0 6.0 | mA |
| Operating Temperature, <i>Ordering Option</i> | T_{OP} | -20/70, -40/85 | | | °C |
| Stability Over Operating Temperature ³ , <i>Ordering Option</i> | | ±0.100, ±0.200, ±0.280, ±1.0 | | | ppm |
| Initial Accuracy, "No Adjust" Option ⁴ | | | | ±1.5 | ppm |
| Power Supply Stability, ±5% change 10MHz-27MHz, 2.8V, 3.0V, and 3.3V >27MHz-52MHz, 2.8V, 3.0V, and 3.3V 10MHz-27MHz, 5V >27MHz-52MHz, 5V | | 1 | | ±0.10 ±0.20 ±0.20 ±0.30 | ppm |
| Load Stability, ±10% change | | | | ±0.10 | ppm |
| Aging | | | | ±0.5 | ppm 1st yr |
| Stability, temperature and 24 hours ⁵ | | | | ±0.37 | ppm |
| Total Stability ⁵ | | | | ±4.6 | ppm |
| Pull Range, <i>Ordering Option</i> | | ±5, ±10 | | | ppm |
| Control Voltage to reach Pull Range | | 0.5 | | 2.5 | V |
| Control Voltage Impedance | | 100 | | | Kohm |
| Output Enable/Disable ⁶ , <i>Ordering Option</i> Output Enabled Output Disabled (high impedance output) | V_{IH} V_{IL} | | $0.2*V_{DD}$ | $0.8*V_{DD}$ | V V |
| Output Level Output Logic High Output Logic Low Output Logic High Drive Output Logic Low Drive | V_{OH} V_{OL} | $0.9*V_{DD}$ 4 | | $0.1*V_{DD}$ -4 | V V mA mA |
| Output Load | | | | 15 | pF |
| Phase Noise, 26.000MHz 10Hz 100Hz 1kHz 10kHz 100kHz | | | -91 -117 -139 -153 -157 | | dBc/Hz |
| Period Jitter ⁷ rms peak-peak | | | 2.5 21.0 | | ps ps |
| Start Up Time | t_{SU} | | | 2 | ms |

1. The Output is DC coupled.
2. The VT-803 power supply pin should be filtered, eg, a 10uF, 0.1uF and 0.01uF capacitor.
3. Not all stabilities are available over all temperatures. Measured at mid Vc for parts with frequency tuning
4. After 2 IR reflows and 24 hours.
5. ±100, ±200 and ±280 ppb temp stability parts, all inclusive with 10 years aging.
6. Output is Enabled if E/D is left open.
7. Measured using a Wavecrest SIA3300C, 90K samples.

Warm Up Time



Figure 1

The VT-803 start up time is rated at 2ms. Figure 1 shows the Output Frequency versus time in seconds which shows the output reaching a steady state frequency within 60 seconds.

Frequency versus Vc Over Temperature



Figure 2

The VT-803 output frequency change versus control voltage is very linear and Figure 2 show the typical performance over temperature.

Allan Deviation, Clipped Sine Wave Output



Figure 3

Test Conditions are under room ambient air flow (non insulated conditions).

Allan Deviation, CMOS Output

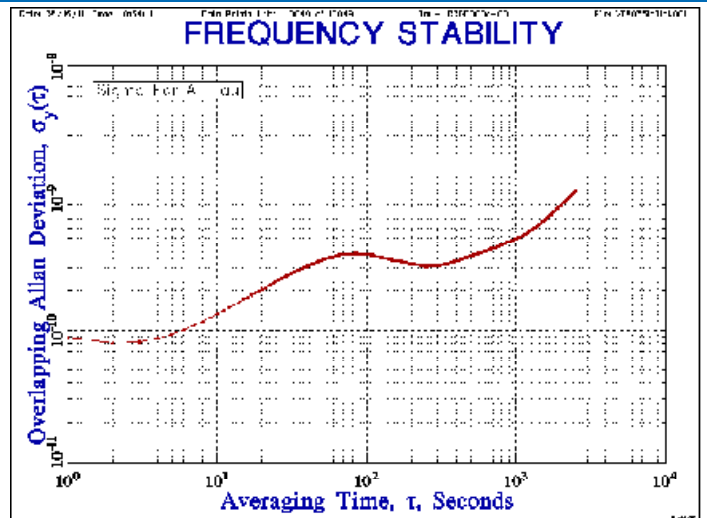

Figure 4

Test Conditions are under room ambient air flow (non insulated conditions).

Aging

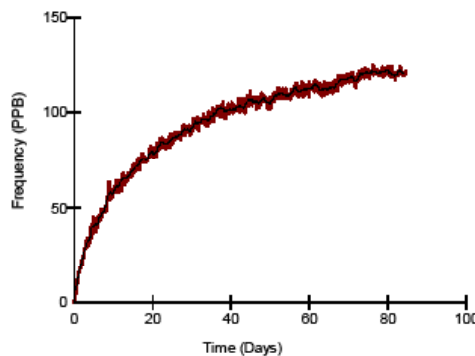
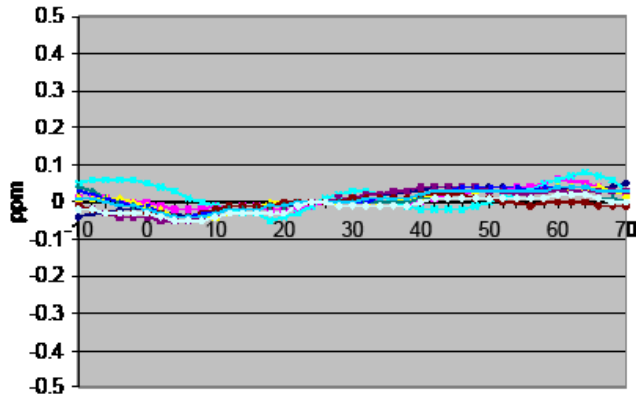

Figure 5

Figure 5 shows an output frequency change of 125ppb typical over 85 days at 85°C which would be equivalent to 125ppb over 2.25 years at 40°C.

Temperature Stability Graph



Temperature °C

Figure 6

Delta Frequency vs. Temperature

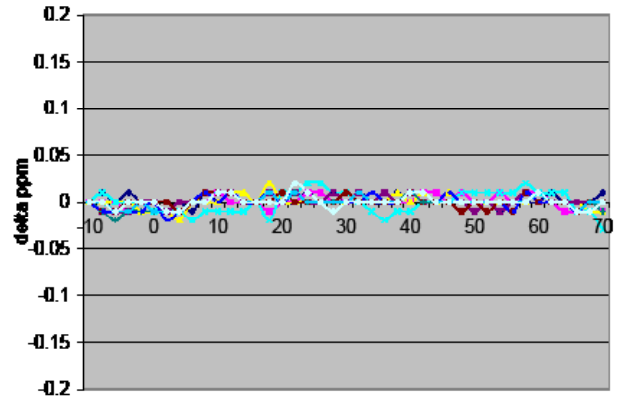

Temperature °C

Figure 7

Figure 7 shows the change in frequency reading between every adjacent 2°C readings.

Phase Noise Performance, Clipped Sine Wave

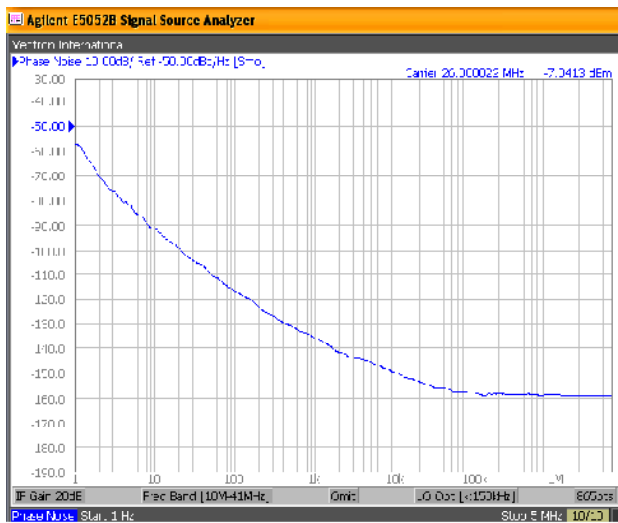

Figure 8

Phase Noise Performance, CMOS

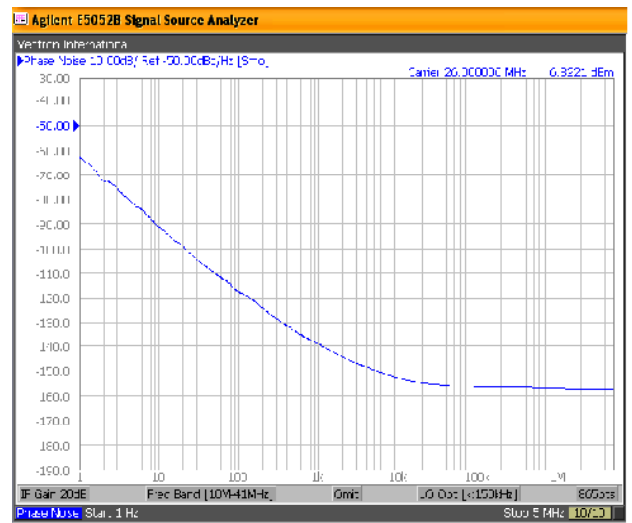

Figure 9

Phase Noise Over Temperature

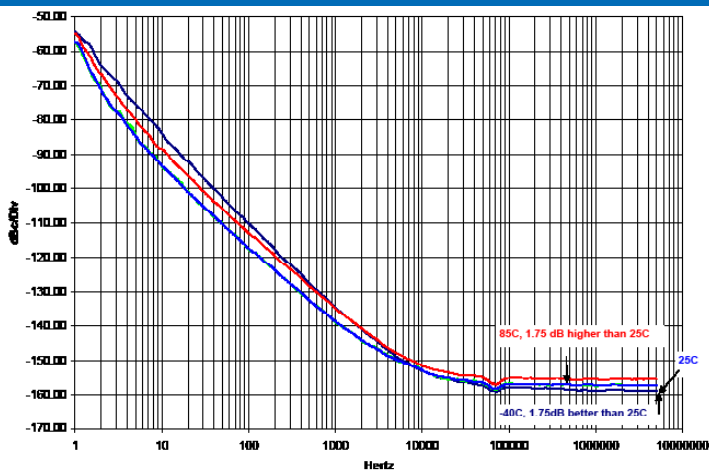

Figure 10

Figure 10 shows the difference in the phase noise at 85°C, 25°C and -40°C.

Phase Noise Over Power Supply Variation

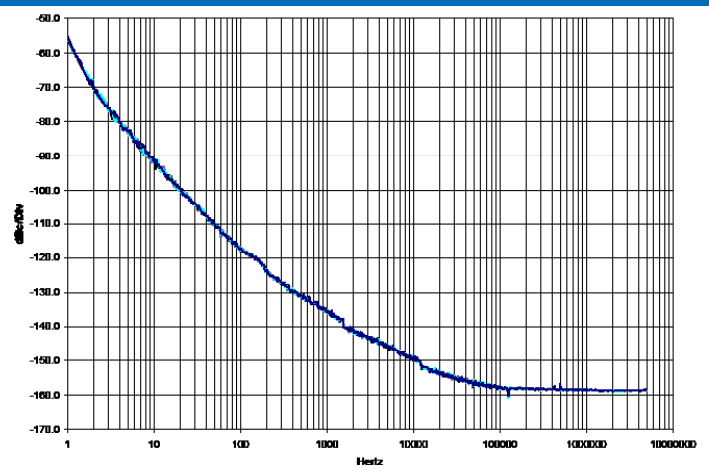

Figure 11

Figure 11 is a phase noise plot at a 2.8, 3.0, 3.3 and 3.6 volt power supply which demonstrates there is no significant change in performance.

VCXO Function

VCXO Feature: The VT-803 is supplied with a VCXO function for applications where it will be used in a PLL, or the output frequency needs fine tune or calibration adjustments. This is a high impedance input, 100 Kohm, and can be driven with an op-amp or terminated with adjustable resistors etc. **Pin 1 should not be left floating on the VCXO optional device.**

Maximum Ratings

Absolute Maximum Ratings and Handling Precautions

Stresses in excess of the absolute maximum ratings can permanently damage the device. Functional operation is not implied or any other excess of conditions represented in the operational sections of this data sheet. Exposure to absolute maximum ratings for extended periods may adversely affect device reliability.

Although ESD protection circuitry has been designed into the VT-803, proper precautions should be taken when handling and mounting, Vectron employs a Human Body Model and Charged Device Model for ESD susceptibility testing and design evaluation. ESD thresholds are dependent on the circuit parameters used to define the model. Although no industry standard has been adopted for the CDM a standard resistance of 1.5kOhms and capacitance of 100pF is widely used and therefore can be used for comparison purposes.

| Parameter | Symbol | Rating | Unit |
|---------------------------|-------------|---------------------|------|
| Storage Temperature | T_{STORE} | -55/125 | °C |
| Supply Voltage | V_{DD} | -0.6/6 | V |
| Control Voltage | V_C | -0.6/ V_{DD} +0.6 | V |
| Enable/Disable Voltage | E/D | -0.6/ V_{DD} +0.6 | V |
| ESD, Human Body Model | | 1500 | V |
| ESD, Charged Device Model | | 1000 | V |

Reliability

| Parameter | Condition |
|----------------------------|--------------------------------------------------|
| Mechanical Shock | MIL-STD-883 Method 2002 (1500 G, 0.5 msec) |
| Mechanical Vibration | MIL-STD-883 Method 2007 (20 G Peak Acceleration) |
| Temperature Cycle | MIL-STD-883 Method 1010 (-55/85°C) |
| Solderability | MIL-STD-883 Method 2003 (Lead free solder) |
| Fine and Gross Leak | MIL-STD-883 Method 1014 (Crystal) |
| Resistance to Solvents | MIL-STD-883 Method 2015 (IPA solvent) |
| Moisture Sensitivity Level | MSL1 |
| Termination Finish | Gold (0.3-1.0um) over Nickel |
| Weight | 70 mg |
| ThetaJC | 6 °C/W |

Test conditions: ±2.0 ppm change limit.

IR Reflow

Suggested IR Profile

Devices are built using lead free epoxy and can be subjected to standard lead free IR reflow conditions shown in Table 7. Contact pads are gold over nickel and lower maximum temperatures can also be used, such as 220°C.

| Table 7 Reflow Profile | | |
|----------------------------------|---------------------------|-------------------------------|
| Parameter | Symbol | Value |
| PreHeat Time Ts-min Ts-max | t_s | 200 sec Max 150°C 200°C |
| Ramp Up | R_{UP} | 3°C/sec Max |
| Time above 217C | t_L | 150 sec Max |
| Time to Peak Temperature | $t_{25C \text{ to peak}}$ | 480 sec Max |
| Time at 260C | t_p | 30 sec Max |
| Time at 240C | t_{p2} | 60 sec Max |
| Ramp down | R_{DN} | 6°C/sec Max |

Solderprofile:

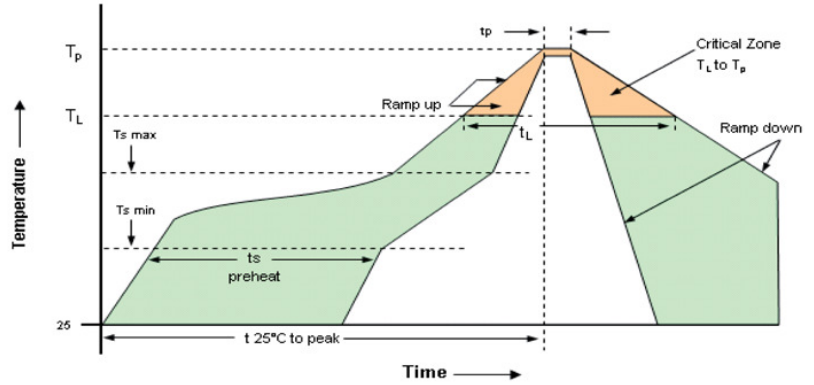

Tape & Reel

Table 8. Tape and Reel Information

| Tape Dimensions (mm) | | | | | | Reel Dimensions (mm) | | | | | | |
|----------------------|-----|-----|----|----|-----|----------------------|----|----|-----|------|------|--------|
| W | F | Do | Po | P1 | A | B | C | D | N | W1 | W2 | #/Reel |
| 12 | 5.5 | 1.5 | 4 | 8 | 254 | 2.5 | 13 | 21 | 100 | 13.5 | 17.5 | 1000 |

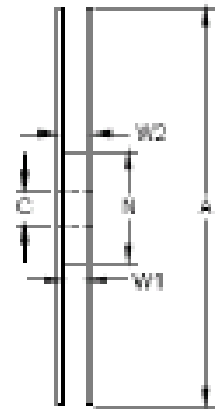
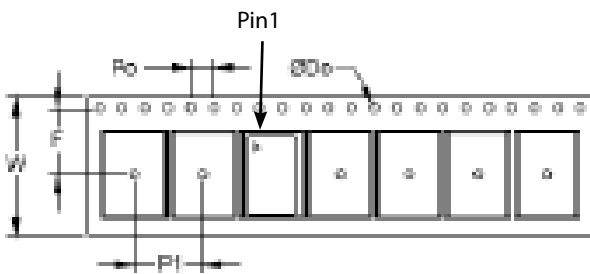

Ordering Information

Table 9. Standard Frequencies (MHz)

| | | | | | | | | | |
|--------|--------|--------|--------|--------|--------|--------|--------|--------|--------|
| 10.000 | 12.800 | 16.000 | 16.384 | 16.800 | 19.200 | 19.440 | 20.000 | 20.480 | 24.000 |
| 24.576 | 25.000 | 26.000 | 27.000 | 28.800 | 29.792 | 30.000 | 30.720 | 31.250 | 32.000 |
| 33.333 | 36.000 | 38.400 | 38.880 | 39.000 | 40.000 | 48.000 | 49.152 | 50.000 | 52.000 |

VT-803- E A E - 507A- xxMxxxxxxxxXX

Product

TCXO

Package

5x3.2 Package

Voltage Options

- D: +5.0 Vdc ±10%
- E: +3.3 Vdc ±10%
- F: +3.0 Vdc ±10%
- G: +2.8 Vdc ±10%

Output

- A: CMOS
- F: Clipped Sine Wave

Temp Range

- J: -20/70°C
- E: -40/85°C

Stability

- 107: ±100ppb
- 207: ±200ppb
- 287: ±280ppb
- 106: ±1.0ppm

Packaging

- TR: Tape and Reel
- blank: Cut Tape / non Tape and Reel quantities
- _SNPB: Tin lead solder dipped

Frequency in MHz

Tuning & E/D Feature

- 0: Fixed, No tuning No E/D
- A: ±5ppm No E/D
- C: ±10ppm No E/D

- 1: Fixed, No tuning E/D Feature
- E: ±5ppm E/D Feature
- G: ±10ppm E/D Feature

Example:

VT-803-EAE-2870-24M5760000TR

VT-803-EAE-2870-24M5760000

VT-803-EAE-2870-24M5760000_SNPB

Tape and Reel

Cut Tape

Tin lead solder dipped

| Revision Date | Description |
|----------------|------------------------------------------------------------------------------------------------------------------------------------------------------------------------------------------------------------------------------------------------------------------------------------------------------------------------------------------------------------------------------------------------------------------------------------------------------------------------------------------------------------------------|
| Nov 4, 2013 | Updated product capability chart (Table 9 & 10). Changed VI Asia contact information. |
| Jan 7, 2014 | Added "temperature stability measurement at Mid Vc for parts with frequency tuning option". Removed Delta 1s Frequency Plot. |
| Feb 18, 2014 | Added temp stability measurement condition on parts with Vc feature. Changed Vectron logo and Hudson contact information. |
| Sep 3, 2014 | Modified Package Drawing Orientation, added tuningl slope (positive), red bullet in Capability Chart |
| June 28, 2018 | Add: E/D function, E/D specifications, E/D Table. New Frequencies,Stratum3/SyncE, ± 4.6 ppm overall stability, ± 0.37 ppm temperature plus 24 hours (for stabilities $\leq \pm 280$ ppb), weight and thetaJC. Updated CMOS load and power supply stability. Update test conditions and clipped sine wave current limit > 26 MHz to 52MHz. Add new Table 3; Enable/Disable Table. Deleted Capabilities Tables 9 and 10. Add _SNPBDIP ordering option and example. Change Vectron logo to Microsemi/Microchip. |
| May 24, 2019 | Update logo, contact information and ordering options. |
| April 30, 2020 | Add tape and reel ordering option |

Contact Information

USA:

100 Watts Street
Mt Holly Springs, PA 17065
Tel: 1.717.486.3411
Fax: 1.717.486.5920

Europe:

Landstrasse
74924 Neckarbischofsheim
Germany
Tel: +49 (0) 7268.801.0
Fax: +49 (0) 7268.801.281



Information contained in this publication regarding device applications and the like is provided only for your convenience and may be superseded by updates. It is your responsibility to ensure that your application meets with your specifications. MICROCHIP MAKES NO REPRESENTATION OR WARRANTIES OF ANY KIND WHETHER EXPRESS OR IMPLIED, WRITTEN OR ORAL, STATUTORY OR OTHERWISE, RELATED TO THE INFORMATION INCLUDING, BUT NOT LIMITED TO ITS CONDITION, QUALITY, PERFORMANCE, MERCHANTABILITY OR FITNESS FOR PURPOSE. Microchip disclaims all liability arising from this information and its use. Use of Microchip devices in life support and/or safety applications is entirely at the buyer's risk, and the buyer agrees to defend, indemnify and hold harmless Microchip from any and all damages, claims, suits, or expenses resulting from such use. No licenses are conveyed, implicitly, or otherwise, under any Microchip intellectual property rights unless otherwise stated.

Trademarks

The Microchip and Vectron names and logos are registered trademarks of Microchip Technology Incorporated in the U.S.A. and other countries.