

# Amphenol

# VG 95234

GCB-B  
GCA-B



Allgemeine Beschreibung / General description / Description générale	2
Elektrische Eigenschaften / Electrical properties / Propriétés électriques	3
Mechanische Eigenschaften / Mechanical properties / Propriétés mécaniques	4
Bestellschlüssel / How to order / Système de référence	5 – 7
VG95234 / GCB-B – Polbilder / Contact arrangements / Arrangements	8 – 13
Einbaumaße / Mounting dimensions / Cotes d'encombrement	13 – 14
Gehäuseformen / Shell style / Style de boîtier	15
VG95234 Form A / VG95234 Style A • VG95234 Form B1, B2 / VG95234 Style B1, B2	16
VG95234 Form D / VG95234 Style D • VG95234 Form E, E1 / VG95234 Style E, E1	17
VG95234 Form F / VG95234 Style F • VG95234 Form G / VG95234 Style G	18
VG95234 Form H / VG95234 Style H • VG95234 Form J1, J2 / VG95234 Style J1, J2	19
VG95234 Form K / VG95234 Style K • VG95234 Form L / VG95234 Style L	20
VG95234 Form M / VG95234 Style M • VG95234 Form N1, N2 / VG95234 Style N1, N2	21
VG95234 Form R1 / VG95234 Style R1 • VG95234 Form S1, S2 / VG95234 Style S1, S2	22
VG95234 Form T / VG95234 Style T • VG95234 Form U1, U2 / VG95234 Style U1, U2	23
VG95234 Form KR, KA / VG95234 Style KR, KA • VG95234 Form KB, KC / VG95234 Style KB, KC	24
VG95234 Blinddosen / VG95234 Dummies / VG95234 Support de serrage VG95234 Klemme / VG95234 Clamp / VG95234 Porte brides	25
VG95234 Knickschutztüllen / VG95234 Bushings / VG95234 Manchons VG95234 Blindstopfen / VG95234 Sealing plug / VG95234 Obturateurs	26
VG95234 Dichtungen / VG95234 Gaskets / VG95234 Joints d'embase	27
GCB-B 3100 PG – PM / GCA-B 3100 PG – PM • GCB-B 3101 PG – PM / GCA-B 3101 PG – PM	28
GCB-B 3106 PG – PM / GCA-B 3106 PG – PM • GCB-B 3107 / GCA-B 3107	29
VG95234 / GCB-B – Stiftkontakte / Pin contacts / Contacts mâles	30
VG95234 / GCB-B – Buchsenkontakte / Socket contacts / Contacts femelles	31
VG95234 / GCB-B – Kontakte / Contacts / Contacts • VG95234 / GCB-B – Werkzeuge / Tools / Outillages	32
GCA-B – Polbilder / Contact arrangements / Arrangements	33 – 50
GCA-B – Werkzeuge / Tools / Outillages	50
GCA-B – Stiftkontakte / Pin contacts / Contacts mâles	51
GCA-B – Buchsenkontakte / Socket contacts / Contacts femelles	52

Wir sind bestrebt, unsere Produkte weiter zu entwickeln und behalten uns maßliche und technische Änderungen an den Steckverbindern vor.

Our products are the subject of continuous development and we reserve the right to introduce changes in their design.

Ce document n'est pas contractuel. Les informations contenues dans ce catalogue sont susceptible d'évolution.

## GCB-B Baureihe

Die Steckverbinder der GCB-B Baureihe mit Reverse-Bajonett-Verschluss entsprechen der Norm VG95234. Sie bieten eine hohe Zuverlässigkeit, sind wasserdicht, verschleiß- und vibrationsfest. Sie haben die gleichen Befestigungsmaße und Polanordnungen wie Steckverbinder nach MIL-C-5015, sind jedoch mit Reverse-Bajonett-Verriegelung und Wellfeder versehen, was schnelles, müheloses Ver- und Entriegeln garantiert und bei starker Vibration einen großen Schutz gegen ungewolltes Entriegeln bietet.

Die nach VG95234 zugelassenen Bauformen sind grundsätzlich mit Einzeladerabdichtung ausgerüstet. Werden bei Steckverbindern nach VG95234 Modifikationen gewünscht, wie z.B. andere Oberflächenbehandlung, Kontaktausführungen oder Endgehäuse, so haben diese grundsätzlich eine GCB-B Bezeichnung.

Typische Anwendungen für diese Baureihen sind Wehrtechnik, industrielle Anlagen und Schienenfahrzeuge, sowie Antriebstechnik, Werkzeugmaschinen, Messtechnik und Robotik.

## GCA-B Baureihe

**Die GCA-B Steckverbinder sind 100% austauschbar- und steckkompatibel mit den Steckverbindern der GCB-B Serie** und bieten eine große Auswahl zusätzlicher Polbilder, die nicht in der VG95234 beschrieben sind. Sie besitzen den gleichen technischen Aufbau wie die GCB-B Serie, bis auf die Kontakte, welche ein anderes Design haben.

## GCB-B Series

These connectors with reverse bayonet coupling are conform to the VG95234 standard. Offering a high liability, they are coevally waterproof and resistant to vibrations and wear. They use the same installation dimensions and contact arrangements as connectors according to MIL-C-5015. However they are provided with reverse bayonet coupling and ondular washer, which guarantee a fast and effortless locking/unlocking and avoid an unintentional unlatch due to heavy vibrations.

All VG95234 designs are basically equipped with an individual wire sealing grommet. If VG95234 connectors are required with modifications, e.g. with solder contacts or other shell- or contact plating, they have to be ordered with GCB-B designation.

Common applications include military sector, industrial plants and railway vehicles as well as propulsion technologies, machine tools, measurement and robotics.

## GCA-B Series

**The GCA-B connectors are fully interchangeable and intermateable with GCB-B connectors** and offer a variety of additional arrangements not described in the VG95234. They have the same technical setup as GCB-B series except the contacts that have a special design.

## Gamme GCB-B

Ces connecteurs à accouplement « Reverse Bayonet » répondent à la norme VG95234. Ils présentent une bonne résistance à l'usure, sont étanches et ont une très bonne tenue aux vibrations. Ils ont les mêmes dimensions de fixation et les mêmes arrangements que les connecteurs conformes à la norme MIL-C-5015. Ils possèdent un système d'accouplement « Reverse Bayonet » incluant une bague ondulée qui garanti un verrouillage / déverrouillage rapide et empêche, lors de vibrations importantes, un désaccouplement intempestif.

Tous les connecteurs VG95234 possèdent un grommet assurant l'étanchéité des conducteurs. Si des modifications sont requises sur les connecteurs VG95234 (traitement de surface, type de contacts, raccord arrière, etc...), ils ne seront livrables que sous la désignation GCB-B.

Les domaines d'utilisation de ces gammes sont le militaire, l'industriel, le ferroviaire, les machines-outils et la robotique.

## Gamme GCA-B

**Les connecteurs GCA-B sont à 100% interchangeables et intermariables avec les connecteurs GCB-B** et offrent un grand nombre d'arrangements supplémentaires non décrits dans la norme VG95234. Ces connecteurs ont les mêmes caractéristiques techniques que la gamme GCB-B, à l'exception des contacts qui ont un design spécifique.

**Nennstrom bei 20°C / Nominal current at 20°C / Courant nominal à 20°C**

Kontaktgröße / Contact size / Taille de contact	Max. Nennstrom / Max. nominal current / Courant nominal maxi (A)
10	8
15S / 16S	22
15 / 16	22
25 / 12	41
60 / 100 / 8	74
160 / 4	135
500 / 0	245

**Betriebsstrom / Rated current / Courant d'utilisation**

In Abhängigkeit von der Umgebungstemperatur / Depending on ambient temperature / En fonction de la température ambiante

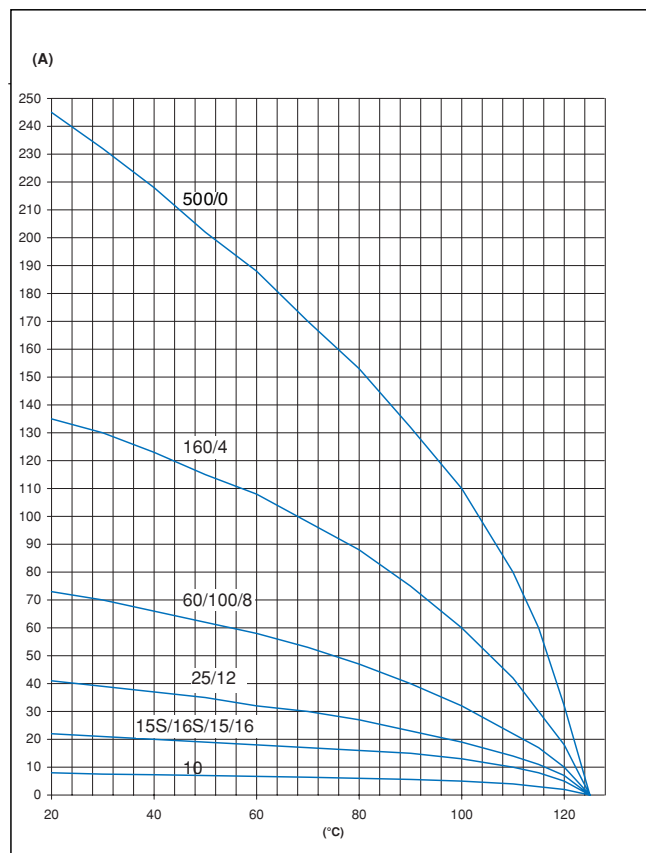

**Isolationswiderstand / Insulation resistance / Résistance d'isolement**

≥ 1000 MΩ

**Durchgangswiderstand / Contact resistance / Résistance de contact**

Die Messpunkte der untenstehenden Abbildung entnehmen / See picture below for measuring conditions / Voir les conditions de mesure suivant vue ci dessous

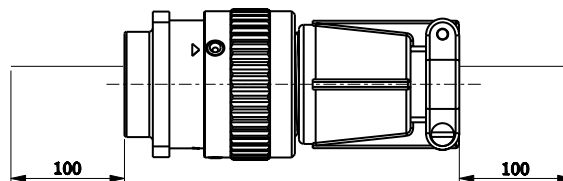

Kontaktgröße / Contact size / Taille de contact	Max. Durchgangswiderstand / Max. contact resistance / Résistance de contact maxi (mΩ)
10	12
15S / 16S	6
15 / 16	6
25 / 12	3
60 / 100 / 8	1
160 / 4	0,5
500 / 4	0,2

**Spannungsfestigkeit / Dielectric withstanding voltage / Rigidité diélectrique**

Spannungsklasse / Voltage class / Classe de tension	Prüfspannung / Test voltage / Tension d'essai Ueff (V)
1	1050
2	1600
3	2500
4	3000

**Luft- und Kriechstrecken / Air creepage and creeping distance / Distance d'isolement dans l'air et le long de la matière**

Spannungsklasse / Voltage class / Classe de tension	1	2	3	4
Wert / Value / Valeur (mm)	0,7	1,1	2,8	4,8

**Betriebsspannung / Rated voltage / Tension d'utilisation**

Werden die in diesem Katalog gezeigten Steckverbinder für Spannungen > 50 Veff gegen Erde eingesetzt, so sind die berührbaren Gehäuseteile zuverlässig in die Schutzmaßnahmen des Gerätes mit einzubeziehen (siehe auch DIN VDE Teil 410 ; IEC 60364-4-41). Diese Steckverbinder dürfen betriebsmäßig nicht unter Spannung gesteckt oder getrennt werden.

If the connectors shown in this catalog are used for voltage > 50 Veff against earth, all accessible conductive parts have to be included reliably into the preventive measures of the equipment.

These connectors can not be connected or disconnected under voltage.

Si les connecteurs cités dans ce catalogue, utilisés avec une tension > 50 Veff sont reliés à la terre, il faut également relier les parties métalliques accessibles (voir également DIN VDE Partie 410; IEC 60364-4-41). Ces connecteurs ne doivent en aucun cas être connectés ou déconnectés sous tension.

**Umgebungstemperatur / Operating temperature /  
Température d'utilisation**

-55 / 125°C

**Steckzyklen / Cycles / Endurance**

500 min.

**Schutzart / IP code / Indice de protection**

Alle Endgehäuse mit Grommet erfüllen IP67 (bei Einzeladern nur in vollbestücktem Zustand). Bei Steckern mit PG- oder metrischem Endgehäuse ist die Schutzart von der Schutzart des Adapters abhängig.

All backshells with grommet are IP 67 (only if all cavities are used). For connectors with PG- or metrical backshell, the IP code depends on the IP code of the adapter which will be used.

Tous les raccords avec grommet sont IP 67 (uniquement si toutes les cavités sont obturées). Pour les connecteurs avec raccord PG- ou métrique, le degré d'étanchéité dépend de celui du serre câble utilisé.

**Schwingung / Vibration / Vibration**

200 m/s<sup>2</sup> bei 10 bis 2000 Hz  
200 m/s<sup>2</sup> at 10 to 2000 Hz  
200 m/s<sup>2</sup> pour 10 à 2000 Hz

**Kontakthalterung / Contact retention /  
Rétention des contacts**

Kontaktgröße / Contact size / Taille de contact	Prüfkraft / Test force / Force de test (N)
10	30
15S / 16S	35
15 / 16	35
25 / 12	55
60 / 100 / 8	80
160 / 4	90
500 / 0	95

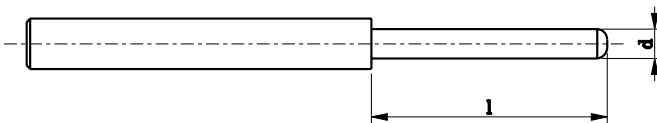
**Prüflehre / Gauge / Calibre**

Prüflehre / Gauge / Calibre	d +0,01	l -1
G 0,99	0,99	7
G 1,56	1,56	9
G 2,36	2,36	12
G 3,58	3,58	13
G 5,69	5,69	13
G 9,04	9,04	13

**Ziehkraft der Prüflehre in der Kontaktbuchse /  
Gauge extraction force in a female contact / Force  
d'extraction d'un calibre dans un contact femelle**

Kontaktgröße / Contact size / Taille de contact	Prüfkraft / Test force / Force de test (N min)	Prüflehre / Gauge / Calibre
10	0,3	G 0,99
15S / 16S	1,0	G 1,56
15 / 16	1,0	G 1,56
25 / 12	1,5	G 2,36
60 / 100 / 8	3,0	G 3,58
160 / 4	4,0	G 5,69
500 / 0	8,5	G 9,04

**Kupplungsdrehmomente / Couplings torques /  
Force d'accouplement**

Werte sind im verkabelten Zustand geben /  
Values are given in wired condition /  
Les valeurs sont données pour des connecteurs câblés.

Gehäusegröße / Shell size / Taille de boîtier	Zulässige Drehmomente / Admissible torques / Moment admissible	
	Schließen und Öffnen / Close and open / Fermeture et ouverture N.m max.	Öffnen / Open / Ouverture N.m min.
10SL	1,7	0,15
14S	3,6	0,35
16S / 16	5,5	0,46
18	8,0	0,58
20	9,0	0,70
22	11,0	0,80
24	14,0	0,80
28	17,0	0,92
32	19,0	1,03
36	23,0	1,03

**Werkstoffe / Materials / Matières**

Gehäuse / Shells / Boîtiers –  
Aluminiumlegierung / Aluminium alloy / Alliage d'aluminium  
Oberfläche olivgrün / Olive drab finish / Finition vert olive  
Andere Oberflächen / Other plating / Autres traitements -  
Siehe Seite / See page / Voir page 7

Kontaktträger / Inserts / Inserts –  
Neopren / Neoprene / Néoprène

Kontakte / Contacts / Contacts –  
Kupferlegierung versilbert / Copper alloy silver plated/ Alliage  
cuivreux argenté  
Andere Oberflächen / Other plating / Autres traitements -  
Siehe Seite / See page / Voir page 7

<b>Bestellschlüssel nach VG95234 / How to order according to VG95234 / Système de référence suivant la VG95234</b>	<b>VG95234</b>	<b>D</b>	<b>-</b>	<b>32-6</b>	<b>S</b>	<b>1</b>	<b>N</b>
Norm / Standard / Norme							
Gehäuseform / Shell style / Style de boîtier							
Gliederungszeichen / Combination symbol / Séparation							
Gehäusegröße-Polbild / Shell size-Contact insert / Taille de boîtier – Insert							
Kontaktart / Contact type / Type de contact							
Anschlussart / Connection type / Type de raccordement							
Winkelstellung / Angular position / Polarisation							

<b>Erläuterung zum Bestellschlüssel / How to order / Explication du système de référence</b>	
Norm / Standard / Norme	VG95234
Gehäuseform / Shell style / Style de boîtier	A, B1, B2 – Gerätesteckdose / Fixed connector / Embase à colerette carrée D, G, H, L, M, R1, T – Gerader Stecker / Free connector straight / Mobile droite E, E1, K – Stecker 90° abgewinkelt / Free connector angular type / Mobile coudée F – Kabelverlängerung / Inline receptacle / Prolongateur J1, J2, N1, N2, S1, S2, U1, U2 – Flanschsteckdose für Hinterwandmontage / Fixed connector for back panel mounting / Embase carrée pour montage arrière
Gehäusegröße / Shell size / Taille de boîtier	10SL, 14S, 16S, 16, 18, 20, 22, 24, 28, 32, 36
Polbild / Contact insert / Insert	Siehe Seite / See page / Voir page 8-13
Kontaktart / Contact type / Type de contact	P – Stift / Pin / Mâle S – Buchse / Socket / Femelle
Anschlussart / Connection type / Type de raccordement	Ohne Kennziffer - Crimpkontakte für metrische Leiterquerschnitte / Without identification number - Crimp contacts for metric conductor cross-sections / Sans identification - Contacts à sertir pour conducteurs métriques  Mit Kennziffer 1 - Crimpkontakte für AWG-Leiterquerschnitte / With identification number 1 - Crimp contact for AWG conductor cross-sections / Avec identification 1 - Contacts à sertir pour conducteurs AWG
Winkelstellung / Angular position / Polarisation	Siehe Seite / See page / Voir page 8-13



<b>Bestellschlüssel nach Amphenol / How to order according to Amphenol / Système de référence Amphenol</b>	<b>GCB</b>	<b>3106</b>	<b>E</b>	<b>-</b>	<b>32-6</b>	<b>S</b>	<b>N</b>	<b>B</b>	<b>-</b>	<b>X</b>
Baureihe / Series / Série										
Gehäuseform / Shell style / Type de boîtier										
Endgehäusetyp / Type of backshell / Type de raccord										
Gliederungszeichen / Combination symbol / Séparation										
Gehäusegröße-Polbild / Shell size-Contact insert / Taille de boîtier – Insert										
Kontaktart / Contact type / Type de contact										
Winkelstellung / Angular position / Polarisation										
Steckverbinder mit Bajonett-Verschluss / Connector with bayonet coupling / Connecteur à baïonnette										
Gliederungszeichen / Combination symbol / Séparation										
Modifikation / Modification / Modification										

<b>Erläuterung zum Bestellschlüssel / How to order / Explication du système de référence</b>	
Baureihe / Series / Série	GCB / GCA
Gehäuseform / Shell style / Style de boîtier	3100 – Flanschsteckdose für Hinterwandmontage / Wall mount receptacle for rear panel mounting / Embase carrée pour montage arrière 3101 – Kabelverlängerung / Cable connecting receptacle / Prolongateur 3102 – Gerätesteckdose für Hinterwandmontage / Box mount receptacle for rear panel mounting / Embase sans possibilité de raccord pour montage arrière 3106 – Gerader Stecker / Free connector straight / Mobile droite 3107 – Steckdose für Einlochmontage / Receptacle for single hole mounting / Embase à fixation par écrou 3108 – Stecker 90° abgewinkelt / Free connector angular type / Mobile coudée
Endgehäusetyp / Type of backshell / Type de raccord	E – Endgehäuse mit Kabelklemme und Kabeltülle / Backshell with cable clamp and bushing / Raccord avec brides et manchon F – Endgehäuse für Schutzschlauchanschluss / Backshell for conduit termination / Raccord pour conduit FG – Endgehäuse für Schutzschlauchanschluss mit 360°HF-Abdichtung durch Massefingerring / Backshell for conduit termination with grounding fingers / Raccord pour conduit avec bague de masse M – Endgehäuse für Schirmanbindung und Formschrumpfteile / Backshell for shielding braids and heat shrinkable endshells / Raccord pour raccordement de blindage et pour pièces thermorétractables N – Endgehäuse für Schirmanbindung durch Einzelkonus und für Formschrumpfteile / Backshell for shielding braids by pressing with a nut and heat shrinkable endshells / Raccord pour raccordement de blindage par simple cône et pour pièces thermorétractables PG – Endgehäuse mit PG-Gewinde, ohne Dichtkörper / Backshell with PG thread, without grommet / Raccord avec taraudage PG, sans grommet PM – Endgehäuse mit metrischem Gewinde, ohne Dichtkörper / Backshell with metrical thread, without grommet / Raccord avec taraudage métrique, sans grommet T – Endgehäuse für Formschrumpfteil / Backshell for heat shrinkable endshells / Raccord pour pièces thermorétractables TG – Endgehäuse für Formschrumpfteil mit 360° HF-Abdichtung durch Massefingerring / Backshell for heat shrinkable endshells with grounding fingers / Raccord pour pièces thermorétractables avec bague de masse
Gehäusegröße / Shell size / Taille de boîtier	10SL, 14S, 16S, 16, 18, 20, 22, 24, 28, 32, 36
Polbild / Contact insert / Insert	Siehe Seite / See page / Voir page – 8-13, 33-50
Kontaktart / Contact type / Type de contact	P – Stift / Pin / Mâle S – Buchse / Socket / Femelle
Winkelstellung / Angular position / Polarisation	Siehe Seite / See page / Voir page – 8-13, 33-50
Modifikation / Modification / Modification	Siehe Seite / See page / Voir page – 7

**Modifikation / Modification / Modification**

Standard-VG95234-Stecker werden mit Oberfläche in Olivgrün und mit versilberten Crimp-Kontakten geliefert.  
**Werden Steckverbinder nach VG95234 modifiziert gewünscht, wie z. B. mit Lötkontakten oder mit anderer Gehäuse- oder Kontaktoberfläche, kann nur unter Amphenol-Bezeichnung GCB-B bestellt werden.**

Standard connectors according to VG95234 are delivered with olive drab finish and silver plated crimp contacts.  
**If VG95234 connectors with modification are required, for example with solder contacts or with other shell- or contact plating, you have to order only with Amphenol-Designation GCB-B.**

Les connecteurs suivant la norme VG95234 sont livrés avec un traitement de surface vert olive et avec des contacts argentés à sertir.

**Si vous désirez des connecteurs modifiés, comme par exemple avec des contacts à souder ou d'autres traitements de surface pour les boîtiers ou les contacts, vous devez utiliser la référence Amphenol GCB-B.**

Modifikation / Modification / Modification	CX	FX	TX
Kontakte / Contacts / Contacts C0 – Metrische Crimp-Kontakte versilbert (Standard bei GCB-B) / Metrical contacts silver plated (standard in GCB-B series) / Contacts métriques argentés à sertir (standard pour la GCB-B) C1 – Metrische Crimp-Kontakte vergoldet / Metrical crimp contacts gold plated / Contacts métriques dorés à sertir C2 – AWG-Crimp-Kontakte versilbert (Standard bei GCA-B) / AWG crimp contacts silver plated (standard in GCA-B series) / Contacts AWG argentés à sertir (standard pour la GCA-B) C3 – AWG-Crimp-Kontakte vergoldet / AWG crimp contacts gold plated / Contacts AWG dorés à sertir C4 – Löt-Kontakte versilbert / Solder contacts silver plated / Contacts argentés à souder C5 – Löt-Kontakte vergoldet / Solder contacts gold plated / Contacts dorés à souder C6 – Ohne Kontakte / Without contacts / Sans contacts			
Gehäuseoberfläche / Shell plating / Traitement de surface des boîtiers Ohne Modifikation - Olivgrün / Without modification - Olive drab finish / Sans modification - Vert olive F1 – Vernickelte Oberfläche / Nickel plating / Finition nickelée F2 – Schwarze Zink-Kobalt-Oberfläche / Black zinc cobalt plating / Finition zinc-cobalt noir			
Gehäusespezifikationen / Shell specification / Spécification sur les boîtiers Ohne Modifikation – Alle Gehäusetypen außer : / Without modification – All shell types except : / Sans modification – Tous les types de boîtiers sauf : T1 – Steckdose für Vorderwandmontage / Receptacle for front panel mounting / Embase pour montage de l'avant T2 – Steckdose mit 4 Gewindebohrungen / Receptacle with 4 threaded holes / Embase avec 4 trous taraudés T42 – Ohne Endgehäuse / Without backshell / Sans raccord			



Kontakt-einsatz / Contact insert / Insert	Anzahl der Kontakte / Number of contacts / Nombre de contacts	Kontaktgröße / Contact size / Taille de contact						Kontakt-einsatz / Contact insert / Insert	Anzahl der Kontakte / Number of contacts / Nombre de contacts	Kontaktgröße / Contact size / Taille de contact					
		500 0	160 4	60 100 8	25 12	15 16	10 20			500 0	160 4	60 100 8	25 12	15 16	10 20
16-12	1		1					36-3	6	3			3		
20-2	1	1						36-6	6	2	4				
10SL-4	2					2		16S-1	7					7	
16S-4	2					2		18-9	7				2	5	
16A11	2				2			24-10	7			7			
24-9	2		2					20A9	9				9		
10SL-3	3					3		22-27	9			1		8	
16-7	3			1		2		24-11	9			3	6		
16-10	3				3			32-3	9	1	2		2	4	
22-2	3			3				18-1	10					10	
18-13	4			1	3			28-20	14				10	4	
22-22	4			4				20A48	19					19	
22B22	4			4				22-14	19					19	
36-5	4	4						28-11	22				4	18	
18-11	5				5			32-6	23		2	3	2	16	
22-12	5			2		3		24-28	24					24	
24-12	5		2		3			28A63	28				9	19	
32-1	5	2			3			32-7	35				7	28	
14S-6	6					6		28-21	37					37	
20-8	6			2		4		36-10	48					48	
28-22	6		3			3		32A69	61					20	41

## Winkelstellung / Angular position / Polarisation

### Winkelstellung der Kontakteinsätze / Angular position of the contact inserts / Polarisation des inserts

Die Winkelstellungen W, X, Y und Z werden angewendet, wenn bei Steckverbindern gleicher Größe und gleicher Polzahl eine Unverwechselbarkeit gefordert wird.

Die nachstehenden Bilder stellen die Ansicht auf die Vorderseite des Stifteinsatzes oder auf die Anschlussseite des Buchseneinsatzes dar.

The angular positions W, X, Y and Z are used when polarisation is required for connectors of the same size and same number of poles.

The following figures show the view on the front face of the pin insert or the termination face of the socket insert.

Les polarisations W, X, Y et Z sont utilisées pour différencier les connecteurs juxtaposés de même arrangement. Les vues ci-dessous montrent la face avant d'un insert mâle ou la face arrière d'un insert femelle.

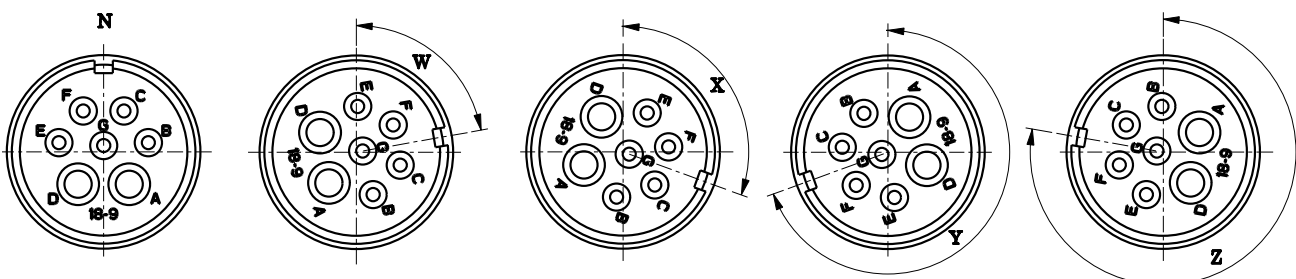

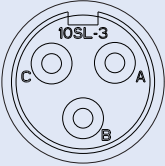
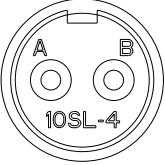
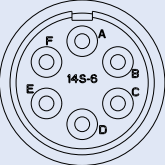
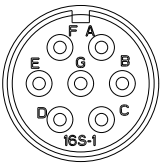
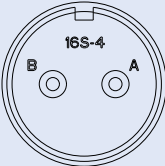
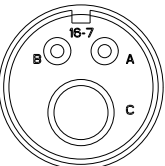
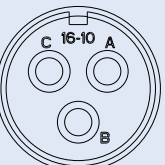
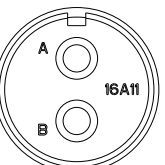
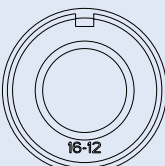
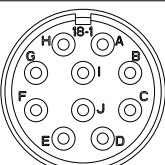
Ansicht auf die Vorderseite des Stifteinsatzes/ Front face of pin insert illustrated/ Vue face avant de l'insert mâle	Polbild / Contact arrangement/ Arrangement	Kontakte / Contacts / Contacts		Spannungsklasse für Kontakte / Voltage class for contacts / Tension d'utilisation des contacts	Winkelstellung der Kontakteinsätze in Grad / Angular position of the contact inserts in degrees / Polarisation des inserts en degrés				
		Anzahl / Number / Nombre	Größe / Size / Taille		N	W	X	Y	Z
	10SL-3	3	15S	2	0	-	-	-	-
	10SL-4	2	15S	2	0	-	-	-	-
	14S-6	6	15S	1	0	-	-	-	-
	16S-1	7	15S	2	0	-	-	-	-
	16S-4	2	15S	3	0	-	110	250	-
	16-7	2	15	2	0	-	110	250	-
		1	100						
	16-10	3	25	2	0	-	180	270	-
	16A11	2 für Stifteinsatz for pin insert pour insert mâle	25A	2	0	-	110	250	-
		2 für Buchseneinsatz for socket insert pour insert femelle	25						
	16-12	1	160	2	0	-	-	-	-
	18-1	10	15	B,C,F,G – 2  A,D,E,H,I,J – 1	0	-	145	215	-

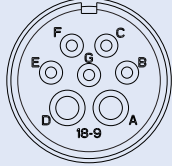
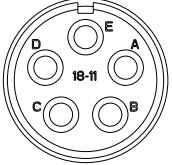
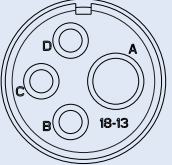
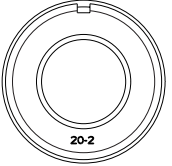
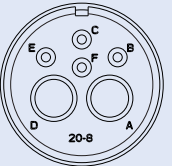
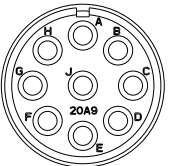
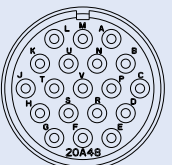
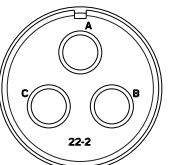
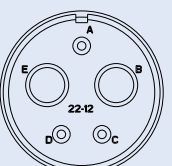
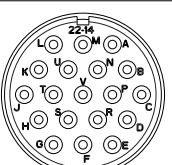
Ansicht auf die Vorderseite des Stifteinsatzes/ Front face of pin insert illustrated/ Vue face avant de l'insert mâle	Polbild / Contact arrangement/ Arrangement	Kontakte / Contacts / Contacts		Spannungsklasse für Kontakte / Voltage class for contacts / Tension d'utilisation des contacts	Winkelstellung der Kontakteinsätze in Grad / Angular position of the contact inserts in degrees / Polarisation des inserts en degrés				
		Anzahl / Number / Nombre	Größe / Size / Taille		N	W	X	Y	Z
	18-9	5	15	1	0	80	110	250	280
		2	25						
	18-11	5	25	2	0	-	170	265	-
	18-13	3	25	2	0	-	110	250	-
		1	60						
	20-2	1	500	3	0	-	-	-	-
	20-8	4	15	1	0	-	110	250	-
		2	100						
	20A9	9	25	J-3 Alle anderen / All others / Autres -1	0	-	110	250	-
	20A48	19	15	1	0	-	80	280	-
	22-2	3	AWG 8	3	0	-	145	215	-
	22-12	3	15	3	0	-	110	250	-
		2	100						
	22-14	19	15	2	0	-	-	-	-

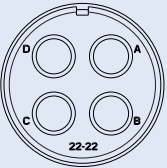
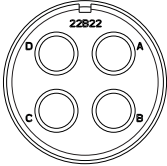
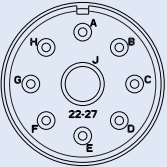
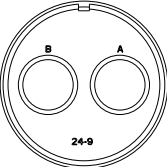
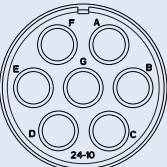
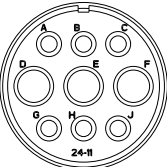
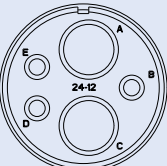
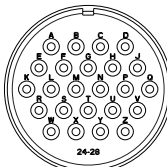
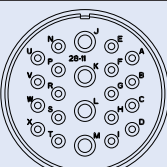
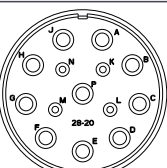
Ansicht auf die Vorderseite des Stifteinsatzes/ Front face of pin insert illustrated/ Vue face avant de l'insert mâle	Polbild / Contact arrangement/ Arrangement	Kontakte / Contacts / Contacts		Spannungsklasse für Kontakte / Voltage class for contacts / Tension d'utilisation des contacts	Winkelstellung der Kontakteinsätze in Grad / Angular position of the contact inserts in degrees / Polarisation des inserts en degrés				
		Anzahl / Number / Nombre	Größe / Size / Taille		N	W	X	Y	Z
	22-22	4	100	2	0	-	110	250	-
	22B22	4	60	2	0	-	110	250	-
	22-27	8	15	J – 3 Alle anderen / All others / Autres –2	0	-	-	250	-
		1	60						
	24-9	2	AWG 4	2	0	35	110	250	325
	24-10	7	100	2	0	-	-	-	-
	24-11	6	AWG 12 (*) / Metr. 25	2	0	-	110	250	-
		3	AWG 8 (*) / Metr. 100						
	24-12	3	AWG 12	2	0	-	110	250	-
		2	AWG 4						
	24-28	24	15	1	0	-	110	250	-
	28-11	18	15	2	0	80	110	250	280
		4	25						
	28-20	4	15	2	0	-	110	250	-
		10	25						

(\*) Nicht für Neukonstruktionen / Not for new design / Pas pour nouveau développement

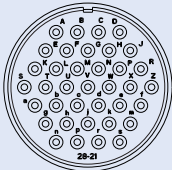
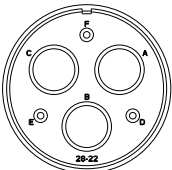
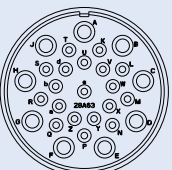
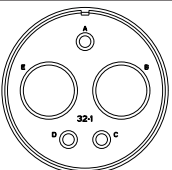
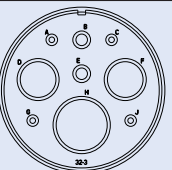
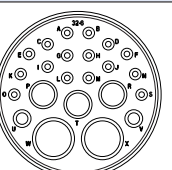
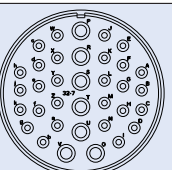
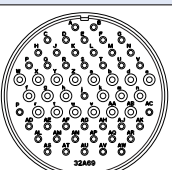
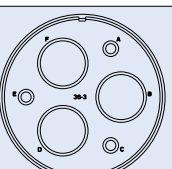
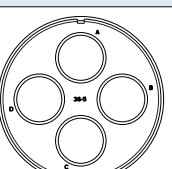
Ansicht auf die Vorderseite des Stifteinsatzes/ Front face of pin insert illustrated/ Vue face avant de l'insert mâle	Polbild / Contact arrangement/ Arrangement	Kontakte / Contacts / Contacts		Spannungsklasse für Kontakte / Voltage class for contacts / Tension d'utilisation des contacts	Winkelstellung der Kontakteinsätze in Grad / Angular position of the contact inserts in degrees / Polarisation des inserts en degrés				
		Anzahl / Number / Nombre	Größe / Size / Taille		N	W	X	Y	Z
	28-21	37	15	2	0	-	110	250	-
	28-22	3	AWG 16 (*) / Metr. 15	3	0	70	145	215	290
		3	AWG 4 (*) / Metr. 160						
	28A63	19	15	1	0	-	100	260	-
		9	25						
	32-1	3	AWG 12 (*) / Metr. 25	A - 4	0	-	110	250	-
		2	AWG 0 (*) / Metr. 500	Alle anderen / All others / Autres - 3					
	32-3	4	AWG 16	3	0	-	110	250	-
		2	AWG 12						
		2	AWG 4						
		1	AWG 0						
	32-6	16	AWG 16 (*) / Metr. 15	2	0	-	110	250	-
		2	AWG 12 (*) / Metr. 25						
		3	AWG 8 (*) / Metr. 60						
		2	AWG 4 (*) / Metr. 160						
	32-7	28	15	1	0	-	125	235	-
		7	25						
	32A69	41	10	1	0	-	110	250	-
		20	15						
	36-3	3	AWG 12 (*) / Metr. 25	3	0	70	145	215	290
		3	AWG 0 (*) / Metr. 500						
	36-5	4	AWG 0 (*) / Metr. 500	2	0	-	120	240	-

(\*) Nicht für Neukonstruktionen / Not for new design / Pas pour nouveau développement

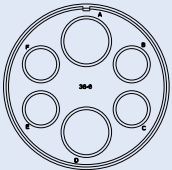
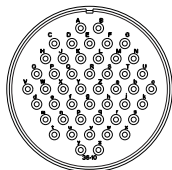
Ansicht auf die Vorderseite des Stifteinsatzes / Front face of pin insert illustrated / Vue face avant de l'insert mâle	Polbild / Contact arrangement / Arrangement	Kontakte / Contacts / Contacts		Spannungsklasse für Kontakte / Voltage class for contacts / Tension d'utilisation des contacts	Winkelstellung der Kontakteinsätze in Grad / Angular position of the contact inserts in degrees / Polarisation des inserts en degrés				
		Anzahl / Number / Nombre	Größe / Size / Taille		N	W	X	Y	Z
	36-6	4	AWG 4	2	0	-	110	250	-
		2	AWG 0						
	36-10	48	15	2	0	-	125	235	-

## Einbaumaße / Mounting dimensions / Cotes d'encombrement

Einbaulöcher für feste Steckverbinder Form A, B1, B2, J1, J2  
N1, N2, S1, S2, U1 und U2.

Mounting inlets for fixed connectors style A, B1, B2, J1, J2,  
N1, N2, S1, S2, U1 and U2.

Découpe des panneaux pour montage des embases style A, B1,  
B2, J1, J2, N1, N2, S1, S2, U1 et U2.

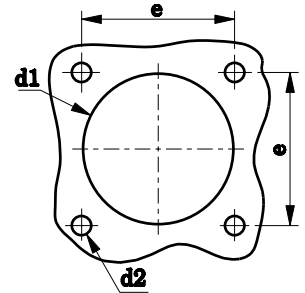

Gehäusegröße / Shell size / Taille de boîtier	d <sub>1</sub>		d <sub>2</sub>		e ± 0,15	Zu verwendende Schrauben nach <sup>(1)</sup> / Applicable screws according to <sup>(1)</sup> / Utilisation de vis suivant <sup>(1)</sup>	
	Form (Style) A	Form (Style) B1, B2, J1, J2 N1, N2, S1, S2 U1, U2	Form (Style) A, B2, J2, N2, S2, U2	Form (Style) B1, J1, N1 S1, U1		DIN 85 Form (Style) A, B2, J2, N2, S2, U2	DIN 84 Form (Style) B1, J1, N1, S1, U1
10SL	17,0	19,1	3,4	4,5	18,2	M3	M4
14S	20,0	25,5	3,4	4,5	23,0	M3	M4
16S	23,0	28,3	3,4	4,5	24,6	M3	M4
16	23,0	28,3	3,4	4,5	24,6	M3	M4
18	26,5	31,7	3,4	4,5	27,0	M3	M4
20	30,0	35,0	3,4	4,5	29,4	M3	M4
22	33,0	38,3	3,4	4,5	31,8	M3	M4
24	36,0	41,8	3,9	4,5	34,9	M3,5	M4
28	42,0	47,6	3,9	5,5	39,7	M3,5	M5
32	48,5	54,3	4,5	5,5	44,5	M4	M5
36	55,0	60,5	4,5	5,5	49,2	M4	M5

<sup>(1)</sup> Bei Verwendung von Sicherungselementen ist darauf zu achten, dass der Außendurchmesser derselben nicht größer als der Durchmesser des Schraubenkopfes ist /  
For using safety elements care shall be taken that the external diameter of safety elements is not larger than the diameter of the screw head /  
Lors de l'utilisation d'éléments de sécurité, il faut s'assurer que le diamètre extérieur n'est pas plus grand que le diamètre extérieur de la tête de vis.



Steckerform / Connector type / Type de connecteur –  
D

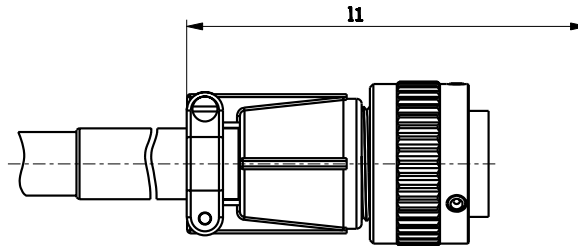

Steckerform / Connector type / Type de connecteur –  
G, M, R1, T

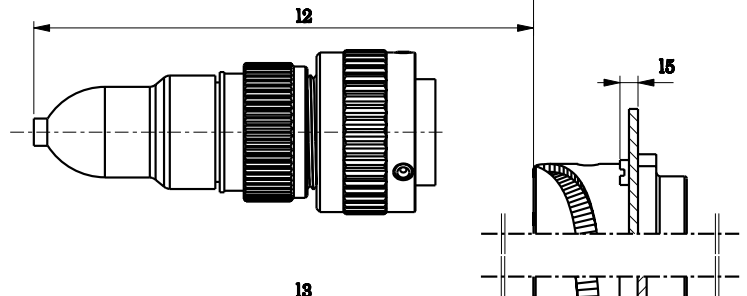

Steckerform / Connector type / Type de connecteur –  
E, E1, K

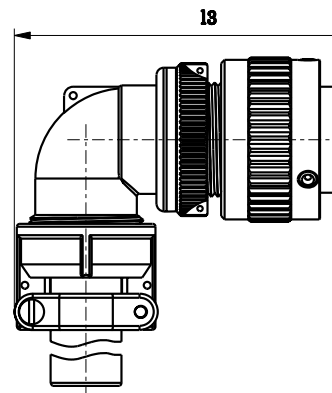

Steckerform / Connector type / Type de connecteur –  
G, M, R1

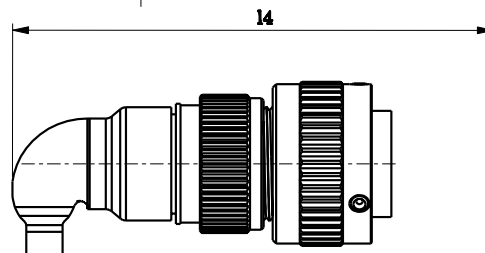

Gehäusegröße / Shell size / Taille de boîtier	$l_1$ min.	$l_2$ min.	$l_3$ min.	$l_4$ min.	$l_5$ max.	$l_5$ max.
10SL	70	70	70	65	8,0	3,5
14S	70	75	75	70	8,0	3,5
16S	70	90	80	80	8,0	3,5
16	80	100	90	90	8,0	3,5
18	90	100	90	90	8,0	3,5
20	90	100	95	100	8,0	3,5
22	90	100	95	100	8,0	3,5
24	110	120	105	110	8,0	5,0
28	110	120	105	110	9,0	5,0
32	110	180	115	120	9,0	6,0
36	110	190	120	130	9,0	6,0

<p>VG95234 Form (Style) A GCB-B / GCA-B 3102 Seite (Page) 16</p>	<p>VG95234 Form (Style) B1 / B2 GCB-B / GCA-B 3102 Seite (Page) 16</p>	<p>VG95234 Form (Style) D GCB-B / GCA-B3106 E Seite (Page) 17</p>	<p>VG95234 Form (Style) E GCB-B / GCA-B 3108 E Seite (Page) 17</p>
			
<p>VG95234 Form (Style) F GCB-B / GCA-B 3101 E Seite (Page) 18</p>	<p>VG95234 Form (Style) G GCB-B / GCA-B 3106 T Seite (Page) 18</p>	<p>VG95234 Form (Style) H GCB-B / GCA-B 3106 F Seite (Page) 19</p>	<p>VG95234 Form (Style) J1 / J2 GCB-B / GCA-B 3100 E Seite (Page) 19</p>
			
<p>VG95234 Form (Style) K GCB-B / GCA-B 3108 FG Seite (Page) 20</p>	<p>VG95234 Form (Style) L GCB-B / GCA-B 3106 FG Seite (Page) 20</p>	<p>VG95234 Form (Style) M GCB-B / GCA-B 3106 M Seite (Page) 21</p>	<p>VG95234 Form (Style) N1 / N2 GCB-B / GCA-B 3100 M Seite (Page) 21</p>
			
<p>VG95234 Form (Style) R1 GCB-B / GCA-B 3106 N Seite (Page) 22</p>	<p>VG95234 Form (Style) S1 / S2 GCB-B / GCA-B 3100 N Seite (Page) 22</p>	<p>VG95234 Form (Style) T GCB-B / GCA-B 3106 TG Seite (Page) 23</p>	<p>VG95234 Form (Style) U1 / U2 GCB-B / GCA-B 3100 T Seite (Page) 23</p>
			
<p>GCB-B / GCA-B 3100 PG – PM Seite (Page) 28</p>	<p>GCB-B / GCA-B 3101 PG – PM Seite (Page) 28</p>	<p>GCB-B / GCA-B 3106 PG – PM Seite (Page) 29</p>	<p>GCB-B / GCA-B 3107 Seite (Page) 29</p>
			

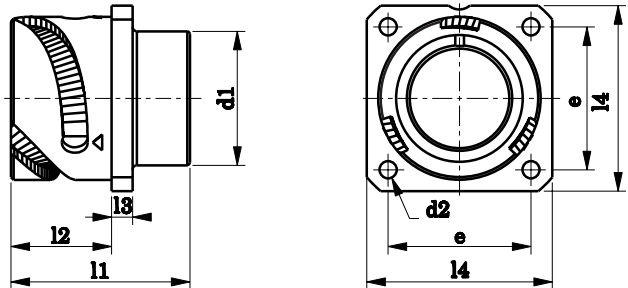

Fester Steckverbinder mit Montageflansch, für Vorderwandmontage.  
Fixed connector with mounting flange for front panel mounting.  
Embase à collerette carrée pour montage sur panneau de l'avant.

Beispiel / Example / Exemple

- VG95234A-18-1SN
- GCB3102-18-1SNB-T1
- GCA3102-18-1SNB-T1

Gehäusegröße / Shell size / Taille de boîtier	d <sub>1</sub> max.	d <sub>2</sub> H13	e ±0,1	l <sub>1</sub> ±0,3	l <sub>2</sub> +0,4	l <sub>3</sub> ±0,2	l <sub>4</sub> ±0,3	Masse / Mass g max. <sup>(1)</sup>
10SL	16,2	3,2	18,2	24,7	14,2	2,8	25,4	12
14S	19,2	3,2	23,0	24,7	14,2	3,2	30,0	17
16S	22,4	3,2	24,6	24,7	14,2	3,2	32,5	19
16	22,4	3,2	24,6	33,8	19,0	3,2	32,5	22
18	25,6	3,2	27,0	33,8	19,0	4,0	35,0	28
20	29,0	3,2	29,4	33,8	19,0	4,0	38,0	33
22	32,2	3,2	31,8	33,8	19,0	4,0	41,0	38
24	35,3	3,7	34,9	33,8	20,6	4,0	44,5	46
28	41,4	3,7	39,7	33,8	20,6	4,0	50,8	52
32	47,8	4,3	44,5	33,8	22,2	4,0	57,0	64
36	54,1	4,3	49,2	33,8	22,2	4,0	63,5	80

<sup>(1)</sup> Masse ohne Kontakteinsätze / Mass without contact inserts / Masse sans inserts

## VG95234 Form B1, B2 / VG95234 Style B1, B2

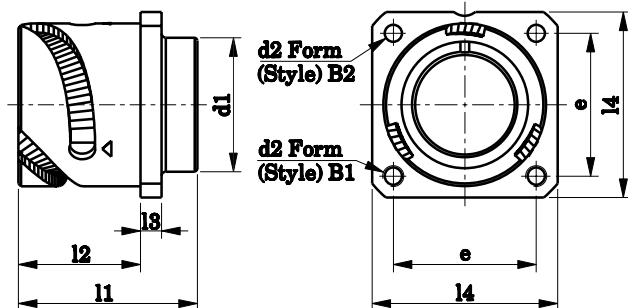

Fester Steckverbinder mit Montageflansch, für Hinterwandmontage.  
Form B1 mit 4 Gewindebohrungen oder B2 mit 4 Durchgangsöffnungen.  
Fixed connector with mounting flange for back panel mounting.  
Style B1 with 4 threaded holes or style B2 with 4 entry holes.  
Embase à collerette carrée pour montage sur panneau de l'arrière.  
Style B1 avec 4 trous taraudés ou style B2 avec 4 trous non taraudés.

Beispiel / Example / Exemple

- VG95234B1-18-1SN
- GCB3102-18-1SNB-T2
- GCA3102-18-1SNB-T2

- VG95234B2-18-1SN
- GCB3102-18-1SNB
- GCA3102-18-1SNB

Gehäusegröße / Shell size / Taille de boîtier	d <sub>1</sub> max.	d <sub>2</sub>		e ±0,1	l <sub>1</sub> ±0,3	l <sub>2</sub> +0,4	l <sub>3</sub> ±0,2	l <sub>4</sub> ±0,3	Masse / Mass g max. <sup>(1)</sup>
		Form (Style) B <sub>1</sub>	Form (Style) B <sub>2</sub> H 13						
10SL	16,2	M 4	3,2	18,2	24,7	18,20	2,8	25,4	14
14S	19,2	M 4	3,2	23,0	24,7	18,20	3,2	30,0	21
16S	22,4	M 4	3,2	24,6	24,7	18,20	3,2	32,5	22
16	22,4	M 4	3,2	24,6	33,8	23,05	3,2	32,5	27
18	25,6	M 4	3,2	27,0	33,8	23,05	4,0	35,0	33
20	29,0	M 4	3,2	29,4	33,8	23,05	4,0	38,0	37
22	32,2	M 4	3,2	31,8	33,8	23,05	4,0	41,0	42
24	35,3	M 4	3,7	34,9	33,8	23,05	4,0	44,5	48
28	41,4	M 5	3,7	39,7	33,8	24,05	4,0	50,8	58
32	47,8	M 5	4,3	44,5	33,8	24,05	4,0	57,0	72
36	54,1	M 5	4,3	49,2	33,8	24,05	4,0	63,5	84

<sup>(1)</sup> Masse ohne Kontakteinsätze / Mass without contact inserts / Masse sans inserts

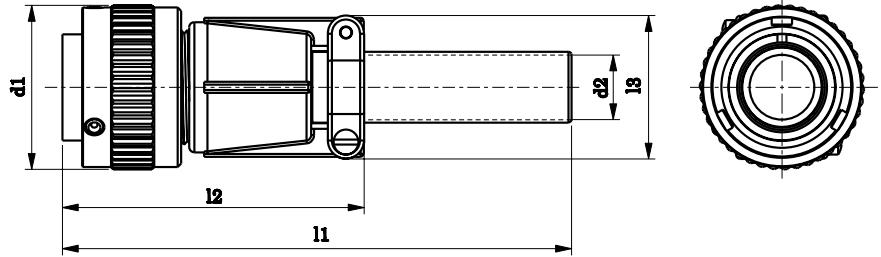

Freier Steckverbinder, gerade, Endgehäuse mit Klemme und Tülle.  
Free connector, straight type, backshell with cable and bushing.  
Mobile droite, raccord avec brides et manchon.

Beispiel / Example / Exemple  
- VG95234D-18-1SN  
- GCB3106E-18-1SNB  
- GCA3106E-18-1SNB

Gehäusegröße / Shell size / Taille de boîtier	d <sub>1</sub> max.	d <sub>2</sub> <sup>(2)</sup> max.	l <sub>1</sub> max.	l <sub>2</sub> max.	l <sub>3</sub> max.	Masse / Mass g max. <sup>(1)</sup>
10SL	22,8	6,5	115	58	22,7	30
14S	29,2	9,0	115	60	27,5	44
16S	32,0	11,0	115	60	30,0	54
16	32,0	11,0	120	70	30,0	62
18	36,5	14,2	120	75	33,0	70
20	39,9	15,8	120	75	37,5	85
22	43,1	15,8	120	75	37,5	92
24	46,6	21,4	120	90	43,3	127
28	53,4	21,4	120	90	48,0	154
32	60,1	26,7	120	90	55,0	199
36	66,3	31,7	130	100	58,0	260

<sup>(1)</sup> Masse ohne Kontakteinsätze / Mass without contact inserts / Masse sans inserts

<sup>(2)</sup> Für max. zulässigen Kabeldurchmesser / For max. admissible cable diameter / Pour diamètre de câble maxi admissible

VG95234 Form E, E1 / VG95234 Style E, E1

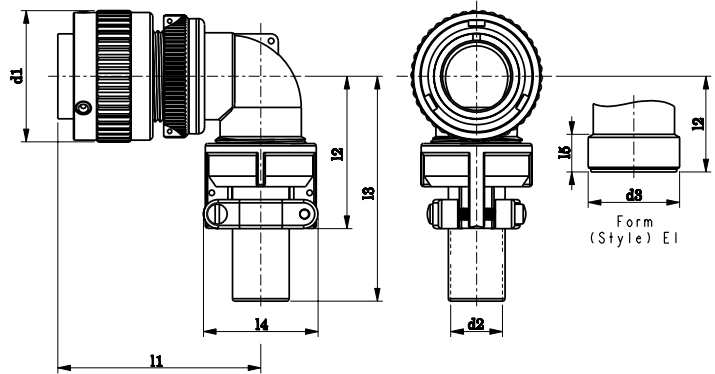

Freier Steckverbinder 90° abgewinkelt.  
Form E mit Kabelklemme und Tülle oder Form E1 für Schutzschlauchanschluss, ohne Kabelklemme.  
Free connector, angular type.  
Style E with cable clamp and bushing or style E1 for conduit termination, without cable clamp.  
Mobile coudée 90°.  
Style E avec brides et manchon ou style E1 pour raccordement de conduit, sans brides.

Beispiel / Example / Exemple  
- VG95234E-18-1SN  
- GCB3108E-18-1SNB  
- GCA3108E-18-1SNB

- VG95234E1-18-1SN  
- GCB3108F-18-1SNB  
- GCA3108F-18-1SNB

Gehäusegröße / Shell size / Taille de boîtier	d <sub>1</sub> max.	d <sub>2</sub> <sup>(2)</sup> max.	d <sub>3</sub> Klasse 2A (Class 2A, Classe 2A)	l <sub>1</sub> max.	l <sub>2</sub> max.		l <sub>3</sub> max.	l <sub>4</sub> max.	l <sub>5</sub> min.	Masse / Mass g max. <sup>(1)</sup>	
					E	E1				E	E1
10SL	22,8	6,5	5/8-24UNEF	45	42	30	100	22,7	9,4	37	27
14S	29,2	9,0	3/4-20UNEF	47	42	30	100	27,5	9,4	58	43
16S	32,0	11,0	7/8-20UNEF	48	45	30	100	30,0	9,4	68	48
16	32,0	11,0	7/8-20UNEF	57	45	35	100	30,0	9,4	78	58
18	36,5	14,2	1-20UNEF	58	53	35	100	33,0	9,4	90	58
20	39,9	15,8	1 3/16-18UNEF	61	53	35	100	37,5	9,4	109	74
22	43,1	15,8	1 3/16-18UNEF	61	58	40	100	37,5	9,4	113	78
24	46,6	21,4	1 7/16-18UNEF	66	58	40	100	43,3	9,4	159	104
28	53,4	21,4	1 7/16-18UNEF	66	58	40	100	48,0	9,4	181	126
32	60,1	26,7	1 3/4-18UNS	72	66	45	110	55,0	11,0	245	160
36	66,3	31,7	2-18UNS	75	69	50	110	58,0	12,6	300	190

<sup>(1)</sup> Masse ohne Kontakteinsätze / Mass without contact inserts / Masse sans inserts

<sup>(2)</sup> Für max. zulässigen Kabeldurchmesser / For max. admissible cable diameter / Pour diamètre de câble maxi admissible

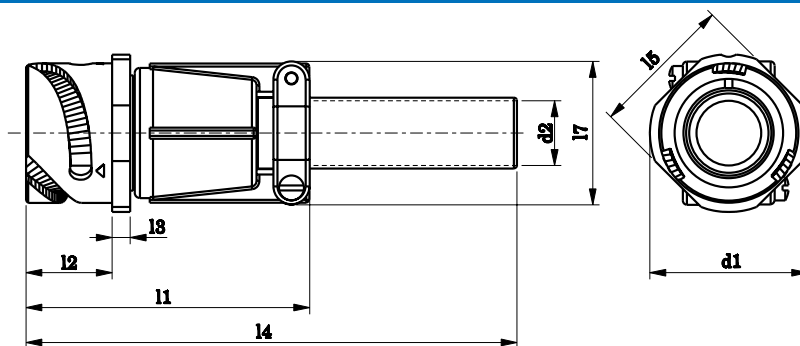

Kabelverlängerung, gerade,  
Endgehäuse mit Klemme und Tülle.  
Inline receptacle, straight type,  
backshell with cable clamp and bushing.  
Prolongateur droit, raccord avec brides  
et manchon.

Beispiel / Example / Exemple  
- VG95234F-18-1SN  
- GCB3101E-18-1SNB  
- GCA3101E-18-1SNB

Gehäusegröße / Shell size / Taille de boîtier	d <sub>1</sub> max.	d <sub>2</sub> <sup>(2)</sup> max.	l <sub>1</sub> max.	l <sub>2</sub> +0,4	l <sub>3</sub> ±0,2	l <sub>4</sub> max.	l <sub>5</sub> ±0,2	l <sub>7</sub> max.	Masse / Mass g max. <sup>(1)</sup>
10SL	25,2	6,5	60	14,2	2,8	120	20,6	22,7	35
14S	29,8	9,0	62	14,2	3,2	120	25,4	27,5	50
16S	32,3	11,0	70	14,2	3,2	120	28,6	30,0	60
16	32,3	11,0	70	19,0	3,2	125	28,6	30,0	65
18	34,8	14,2	77	19,0	4,0	125	31,7	33,0	80
20	37,8	15,8	77	19,0	4,0	125	34,9	37,5	95
22	41,1	15,8	77	19,0	4,0	125	38,1	37,5	105
24	44,6	21,4	85	20,6	4,0	125	41,3	43,3	140
28	50,9	21,4	85	20,6	4,0	125	47,6	48,0	160
32	57,1	26,7	85	22,2	4,0	125	54,0	55,0	205
36	63,6	31,7	105	22,2	4,0	135	60,6	58,0	270

<sup>(1)</sup> Masse ohne Kontakteinsätze / Mass without contact inserts / Masse sans inserts

<sup>(2)</sup> Für max. zulässigen Kabeldurchmesser / For max. admissible cable diameter / Pour diamètre de câble  
maxi admissible

## VG95234 Form G / VG95234 Style G

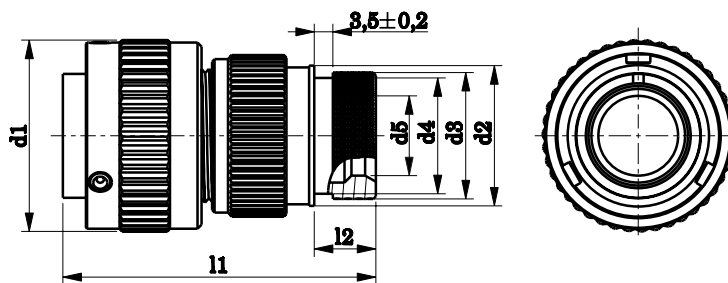

Freier Steckverbinder mit Endgehäuse  
für Formschrumpfteile.  
Free connector with backshell for heat  
shrinkable endshells.  
Mobile droite avec raccord pour pièces  
thermorétractables.

Beispiel / Example / Exemple  
- VG95234G-18-1SN  
- GCB3106T-18-1SNB  
- GCA3106T-18-1SNB

Gehäusegröße / Shell size / Taille de boîtier	d <sub>1</sub> max.	d <sub>2</sub> ±0,2	d <sub>3</sub> ±0,2	d <sub>4</sub> max.	d <sub>5</sub> min.	l <sub>1</sub> max.	l <sub>2</sub> ±0,5	Masse / Mass g max. <sup>(1)</sup>
10SL	22,8	17,0	15,5	13,3	7,7	50	11,7	24
14S	29,2	20,1	19,1	17,0	10,6	50	11,7	41
16S	32,0	23,5	23,9	21,9	13,5	50	11,7	51
16	32,0	23,5	23,9	21,9	13,5	60	11,5	58
18	36,5	26,5	23,9	21,9	14,6	60	11,5	65
20	39,9	30,2	29,6	26,2	18,7	65	12,7	75
22	43,1	33,6	29,6	26,2	20,8	65	12,7	80
24	46,6	36,1	37,8	34,5	24,6	65	12,7	95
28	53,4	41,4	37,8	34,5	27,0	65	12,7	120
32	60,1	48,6	47,8	43,6	33,3	70	15,2	165
36	66,3	54,8	47,8	43,6	38,5	80	15,2	180

<sup>(1)</sup> Masse ohne Kontakteinsätze / Mass without contact inserts / Masse sans inserts

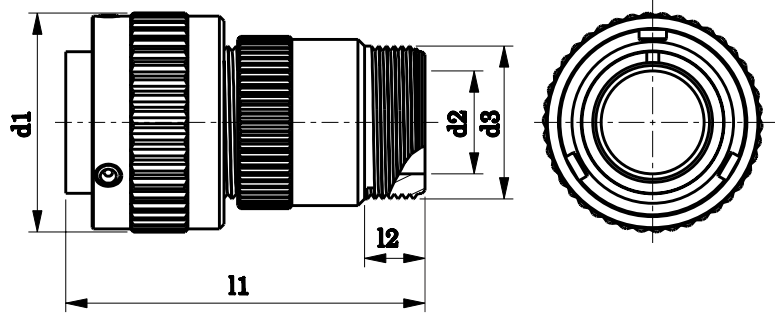

Freier Steckverbinder, gerade, Endgehäuse für Schutzschlauchanschluss.  
Free connector, straight type, backshell for conduit termination.  
Mobile droite, raccord pour conduit.

Beispiel / Example / Exemple  
- VG95234H-18-1SN  
- GCB3106F-18-1SNB  
- GCA3106F-18-1SNB

Gehäusegröße / Shell size / Taille de boîtier	d <sub>1</sub> max.	d <sub>2</sub> min.	d <sub>3</sub> Klasse 2A (Class 2A, Classe 2A)	l <sub>1</sub> max.	l <sub>2</sub> min.	Masse / Mass g max. <sup>(1)</sup>
10SL	22,8	8,2	5/8-24UNEF	50	9,5	21
14S	29,2	11,1	3/4-20UNEF	50	9,5	33
16S	32,0	14,3	7/8-20UNEF	50	9,5	42
16	32,0	14,3	7/8-20UNEF	60	9,5	51
18	36,5	16,7	1-20UNEF	60	9,5	59
20	39,9	19,8	1 3/16-18UNEF	60	9,5	58
22	43,1	19,8	1 3/16-18UNEF	60	9,5	62
24	46,6	25,4	1 7/16-18UNEF	65	9,5	84
28	53,4	27,0	1 7/16-18UNEF	65	9,5	100
32	60,1	32,5	1 3/4-18UNS	65	11,0	116
36	66,3	35,7	2-18UNS	80	11,8	142

<sup>(1)</sup> Masse ohne Kontakteinsätze / Mass without contact inserts / Masse sans inserts

VG95234 Form J1, J2 / VG95234 Style J1, J2

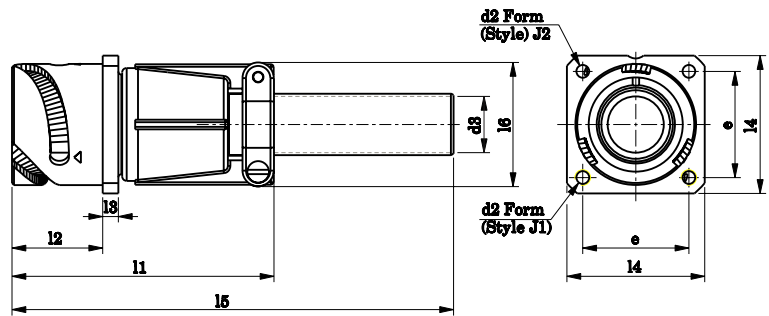

Fester Steckverbinder mit Montageflansch, Klemme und Tülle. Form J1 mit 4 Gewindebohrungen oder Form J2 mit 4 Durchgangslöchern.  
Fixed connector, with mounting flange, cable clamp and bushing.  
Style J1 with 4 threaded holes or style J2 with 4 entry holes.  
Embase à collerette carrée avec brides et manchon.  
Style J1 avec 4 trous taraudés ou J2 avec 4 trous non taraudés.

Beispiel / Example / Exemple  
- VG95234J1-18-1SN  
- GCB3100E-18-1SNB-T2  
- GCA3100E-18-1SNB-T2

- VG95234J2-18-1SN  
- GCB3100E-18-1SNB  
- GCA3100E-18-1SNB

Gehäusegröße / Shell size / Taille de boîtier	d <sub>2</sub>		d <sub>3</sub> max.	e ±0,1	l <sub>1</sub> max.	l <sub>2</sub> +0,4	l <sub>3</sub> ±0,2	l <sub>4</sub> ±0,3	l <sub>5</sub> max.	l <sub>6</sub> max.	Masse / Mass g max. <sup>(1)</sup>
	Form (Style) J1	Form (Style) J2 H13									
10SL	M4	3,2	6,5	18,2	60	18,2	2,8	25,4	120	22,7	35
14S	M4	3,2	9,0	23,0	62	18,2	3,2	30,0	120	27,5	50
16S	M4	3,2	11,0	24,6	70	18,2	3,2	32,5	120	30,0	60
16	M4	3,2	11,0	24,6	70	23,05	3,2	32,5	125	30,0	65
18	M4	3,2	14,2	27,0	77	23,05	4,0	35,0	125	33,0	80
20	M4	3,2	15,8	29,4	77	23,05	4,0	38,0	125	37,5	95
22	M4	3,2	15,8	31,8	77	23,05	4,0	41,0	125	37,5	105
24	M4	3,7	21,4	34,9	85	23,05	4,0	44,5	125	43,3	140
28	M5	3,7	21,4	39,7	85	24,05	4,0	50,8	125	48,0	160
32	M5	4,3	26,7	44,5	85	24,05	4,0	57,0	125	55,0	205
36	M5	4,3	31,7	49,2	105	24,05	4,0	63,5	135	58,0	270

<sup>(1)</sup> Masse ohne Kontakteinsätze / Mass without contact inserts / Masse sans inserts

<sup>(2)</sup> Für max. zulässigen Kabeldurchmesser / For max. admissible cable diameter / Pour diamètre de câble maxi admissible



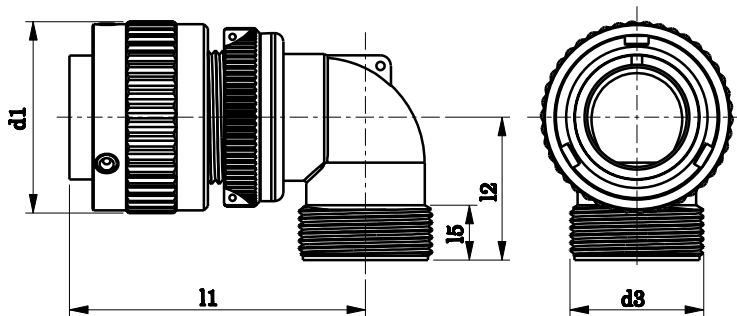

Freier Steckverbinder, 90° abgewinkelt, mit 360° HF-Abdichtung durch Massefingerring und Endgehäuse für Schutzschlauchanschluss.  
Free connector, angular type with grounding fingers and backshell for conduit termination.  
Mobile coudée 90° avec bague de masse et raccord pour conduit.

Beispiel / Example / Exemple

- VG95234K-18-1SN
- GCB3108FG-18-1SNB
- GCA3108FG-18-1SNB

Gehäusegröße / Shell size / Taille de boîtier	d <sub>1</sub> max.	d <sub>3</sub> Klasse 2A (Class 2A, Classe 2A)	l <sub>1</sub> max.	l <sub>2</sub> max.	l <sub>5</sub> min.	Masse / Mass g max. <sup>(1)</sup>
10SL	22,8	5/8-24UNEF	45	30	9,4	27
14S	29,2	3/4-20UNEF	47	30	9,4	43
16S	32,0	7/8-20UNEF	48	30	9,4	48
16	32,0	7/8-20UNEF	57	35	9,4	58
18	36,5	1-20UNEF	58	35	9,4	58
20	39,9	1 3/16-18UNEF	61	35	9,4	74
22	43,1	1 3/16-18UNEF	61	40	9,4	78
24	46,6	1 7/16-18UNEF	66	40	9,4	104
28	53,4	1 7/16-18UNEF	66	40	9,4	126
32	60,1	1 3/4-18UNS	72	45	11,0	160
36	66,3	2-18UNS	75	50	12,6	190

<sup>(1)</sup> Masse ohne Kontakteinsätze / Mass without contact inserts / Masse sans inserts

## VG95234 Form L / VG95234 Style L

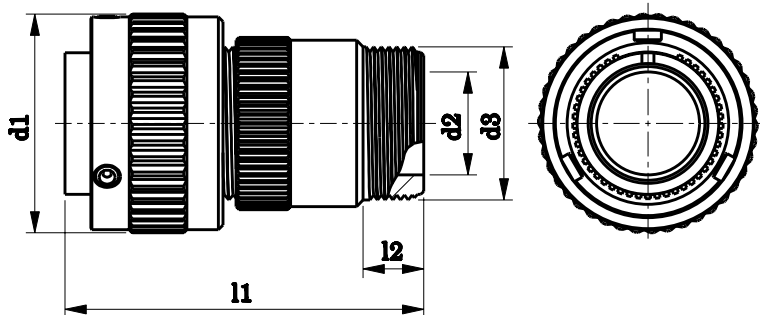

Freier Steckverbinder, gerade, mit 360° HF-Abdichtung durch Massefingerring und Endgehäuse für Schutzschlauchanschluss.  
Free connector, straight type with grounding fingers and backshell for conduit termination.  
Mobile droite avec bague de masse et raccord pour conduit.

Beispiel / Example / Exemple

- VG95234L-18-1SN
- GCB3106FG-18-1SNB
- GCA3106FG-18-1SNB

Gehäusegröße / Shell size / Taille de boîtier	d <sub>1</sub> max.	d <sub>2</sub> min.	d <sub>3</sub> Klasse 2A (Class 2A, Classe 2A)	l <sub>1</sub> max.	l <sub>2</sub> min.	Masse / Mass g max. <sup>(1)</sup>
10SL	22,8	8,2	5/8-24UNEF	50	9,5	21
14S	29,2	11,1	3/4-20UNEF	50	9,5	33
16S	32,0	14,3	7/8-20UNEF	50	9,5	42
16	32,0	14,3	7/8-20UNEF	60	9,5	51
18	36,5	16,7	1-20UNEF	60	9,5	59
20	39,9	19,8	1 3/16-18UNEF	60	9,5	58
22	43,1	19,8	1 3/16-18UNEF	60	9,5	62
24	46,6	25,4	1 7/16-18UNEF	65	9,5	84
28	53,4	27,0	1 7/16-18UNEF	65	9,5	100
32	60,1	32,5	1 3/4-18UNS	65	11,0	116
36	66,3	35,7	2-18UNS	80	11,8	142

<sup>(1)</sup> Masse ohne Kontakteinsätze / Mass without contact inserts / Masse sans inserts

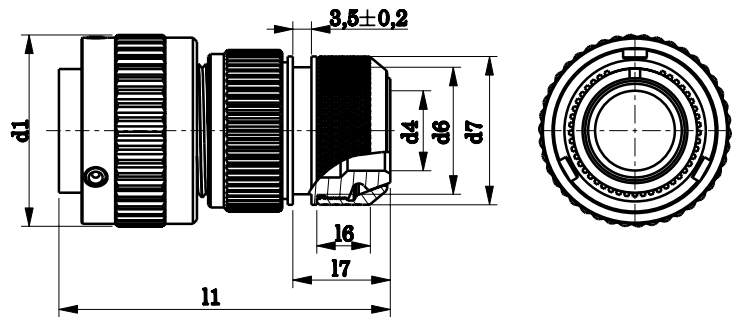

Freier Steckverbinder, gerade, mit 360° HF-Abdichtung durch Massefingerring und Endgehäuse für Schirmanbindung und für Formschrumpfteile.

Free connector, straight type with grounding fingers and backshell for shielding and heat shrinkable endshells.

Mobile droite avec bague de masse et raccord pour blindage et pour pièces thermorétractables.

Beispiel / Example / Exemple

- VG95234M-18-1SN
- GCB3106M-18-1SNB
- GCA3106M-18-1SNB

Gehäusegröße / Shell size / Taille de boîtier	d <sub>1</sub> max.	d <sub>4</sub> min.	d <sub>6</sub> max.	d <sub>7</sub> ±0,5	l <sub>1</sub> max.	l <sub>6</sub> + 2	l <sub>7</sub> + 1	Masse / Mass g max. <sup>(1)</sup>
10SL	22,8	8,6	16,3	18,5	55	7	17	40
14S	29,2	10,6	20,0	22,0	57	7	17	45
16S	32,0	13,5	23,0	25,0	60	8	18	55
16	32,0	13,5	23,0	25,0	70	8	18	65
18	36,5	14,6	24,5	28,0	70	10	18	75
20	39,9	18,5	28,5	32,0	70	10	18	85
22	43,1	20,8	30,5	34,0	70	10	18	100
24	46,6	24,6	34,5	38,0	70	10	18	115
28	53,4	27,0	37,5	41,0	70	10	18	130
32	60,1	33,3	44,0	48,0	70	10	18	170
36	66,3	38,5	51,0	55,0	80	10	18	190

<sup>(1)</sup> Masse ohne Kontakteinsätze / Mass without contact inserts / Masse sans inserts

VG95234 Form N1, N2 / VG95234 Style N1, N2

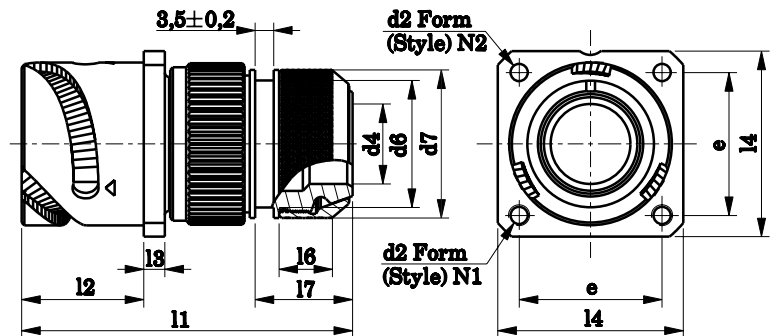

Fester Steckverbinder mit Endgehäuse für den Klemmanschluss von Schirmgeflechten und für Formschrumpfteile. Form N1 mit 4 Gewindebohrungen oder N2 mit 4 Durchgangslöchern.

Fixed connector with mounting flange and backshell for mounting of shielding braids by pressing with a nut and for heat shrinkable endshells.

Style N1 with 4 threaded holes or style N2 with 4 entry holes.

Embase à collerette carrée avec raccord pour blindage et pour pièces thermorétractables. Style N1 avec 4 trous taraudés ou N2 avec 4 trous non taraudés.

Beispiel / Example / Exemple

- VG95234N1-18-1SN
- GCB3100M-18-1SNB-T2
- GCA3100M-18-1SNB-T2
- VG95234N2-18-1SN
- GCB3100M-18-1SNB
- GCA3100M-18-1SNB

Gehäusegröße / Shell size / Taille de boîtier	d <sub>2</sub>		d <sub>4</sub> min.	d <sub>6</sub> max.	d <sub>7</sub> ±0,5	e ±0,1	l <sub>1</sub> max.	l <sub>2</sub> +0,4	l <sub>3</sub> ±0,2	l <sub>4</sub> ±0,3	l <sub>6</sub> +2	l <sub>7</sub> +1	Masse / Mass g max. <sup>(1)</sup>
	Form (Style) N1	Form (Style) N2 H13											
10SL	M4	3,2	8,6	16,3	18,5	18,2	55	18,2	2,8	25,4	7	17	45
14S	M4	3,2	10,6	20,0	22,0	23,0	58	18,2	3,2	30,0	7	17	55
16S	M4	3,2	13,5	23,0	25,0	24,6	70	18,2	3,2	32,5	8	18	65
16	M4	3,2	13,5	23,0	25,0	24,6	70	23,05	3,2	32,5	8	18	75
18	M4	3,2	14,6	24,5	28,0	27,0	70	23,05	4,0	35,0	10	18	85
20	M4	3,2	18,5	28,5	32,0	29,4	70	23,05	4,0	38,0	10	18	95
22	M4	3,2	20,8	30,5	34,0	31,8	70	23,05	4,0	41,0	10	18	105
24	M4	3,7	24,6	34,5	38,0	34,9	70	23,05	4,0	44,5	10	18	120
28	M5	3,7	27,0	37,5	41,0	39,7	70	24,05	4,0	50,8	10	18	150
32	M5	4,3	33,3	44,0	48,0	44,5	75	24,05	4,0	57,0	10	18	190
36	M5	4,3	38,5	51,0	55,0	49,2	85	24,05	4,0	63,5	10	18	220

<sup>(1)</sup> Masse ohne Kontakteinsätze / Mass without contact inserts / Masse sans inserts

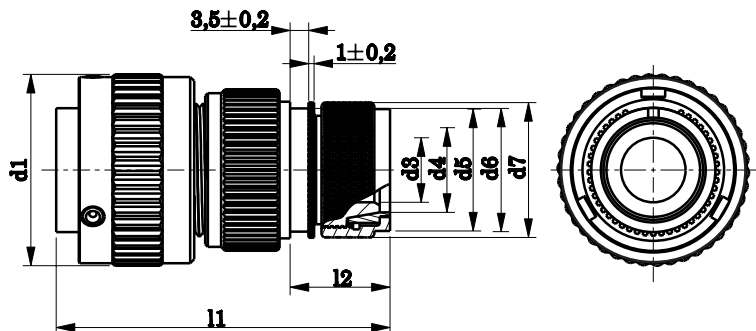

Freier Steckverbinder, gerade, mit 360° HF-Abdichtung durch Massefingerring und Endgehäuse für Schirmanbindung und für Formschumpfteile.

Free connector, straight type with grounding fingers and backshell for shielding and heat shrinkable endshells.

Mobile droite avec bague de masse et raccord pour blindage et pour pièces thermorétractables.

Beispiel / Example / Exemple

- VG95234R1-18-1SN

- GCB3106N-18-1SNB

- GCA3106N-18-1SNB

Gehäusegröße / Shell size / Taille de boîtier	d <sub>1</sub> max.	d <sub>3</sub> +0,2	d <sub>4</sub> +0,4	d <sub>5</sub>	d <sub>6</sub> ±0,3	d <sub>7</sub> ±0,3	l <sub>1</sub> max.	l <sub>2</sub> max.	Masse / Mass g max. <sup>(1)</sup>
14S	29,2	10,0	14,0	M20x1	21,0	23,5	57	21,0	50
16S	32,0	10,0	14,0	M20x1	21,0	23,5	57	21,0	60
18	36,5	12,2	16,0	M22x1	23,0	25,5	66	21,0	80
20	39,9	13,4	18,0	M27x1	26,6	30,5	68	21,0	90
28	53,4	19,0	26,5	M35x1	37,5	41,5	75	26,0	135
32	60,1	21,0	26,5	M35x1	37,5	41,5	79	26,0	175

<sup>(1)</sup> Masse ohne Kontakteinsätze / Mass without contact inserts / Masse sans inserts

## VG95234 Form S1, S2 / VG95234 Style S1, S2

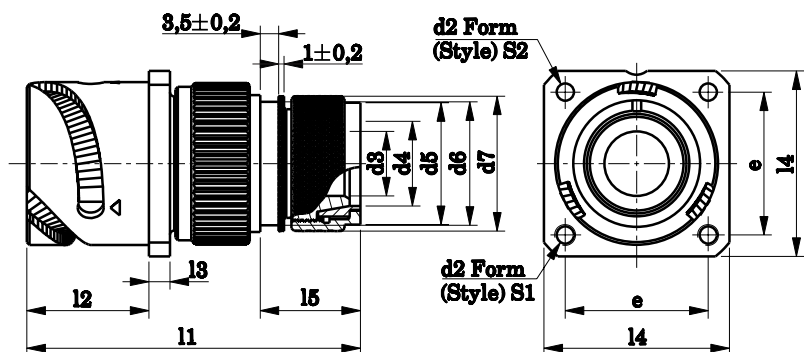

Fester Steckverbinder mit Endgehäuse für den Klemmanschluss von Schirmgeflechten und für Formschumpfteile.

Form S1 mit 4 Gewindebohrungen oder S2 mit 4 Durchgangslöchern. Fixed connector with mounting flange and backshell for mounting of shielding braids by pressing with a nut and for heat shrinkable endshells. Style S1 with 4 threaded holes or style S2 with 4 entry holes.

Embase à collerette carrée avec raccord pour blindage et pour pièces thermorétractables. Style S1 avec 4 trous taraudés ou S2 avec 4 trous non taraudés.

Beispiel / Example / Exemple

- VG95234S1-18-1SN

- GCB3100N-18-1SNB-T2

- GCA3100N-18-1SNB-T2

- VG95234S2-18-1SN

- GCB3100N-18-1SNB

- GCA3100N-18-1SNB

Gehäusegröße / Shell size / Taille de boîtier	d <sub>2</sub>		d <sub>3</sub> ±0,2	d <sub>4</sub> +0,4	d <sub>5</sub>	d <sub>6</sub> ±0,3	d <sub>7</sub> ±0,3	e ±0,1	l <sub>1</sub> max.	l <sub>2</sub> ±0,4	l <sub>3</sub> ±0,2	l <sub>4</sub> ±0,3	l <sub>5</sub> max.	Masse / Mass g max. <sup>(1)</sup>
	Form (Style) S1	Form (Style) S2 H13												
14S	M4	3,2	10,0	14,0	M20x1	21,0	23,5	23,0	61,0	18,2	3,2	30,0	21,0	60
16S	M4	3,2	10,0	14,0	M20x1	21,0	23,5	24,6	61,0	18,2	3,2	32,6	21,0	70
18	M4	3,2	12,2	16,0	M22x1	23,0	25,5	27,0	70,0	23,05	4,0	35,0	21,0	80
20	M4	3,2	13,4	18,0	M27x1	26,6	30,5	29,4	72,0	23,05	4,0	38,0	21,0	90
28	M5	3,7	19,0	26,5	M35x1	37,5	41,5	39,7	78,0	24,05	4,0	50,8	26,0	155
32	M5	4,3	21,0	26,5	M35x1	37,5	41,5	44,5	81,0	24,05	4,0	57,0	26,0	195

<sup>(1)</sup> Masse ohne Kontakteinsätze / Mass without contact inserts / Masse sans inserts

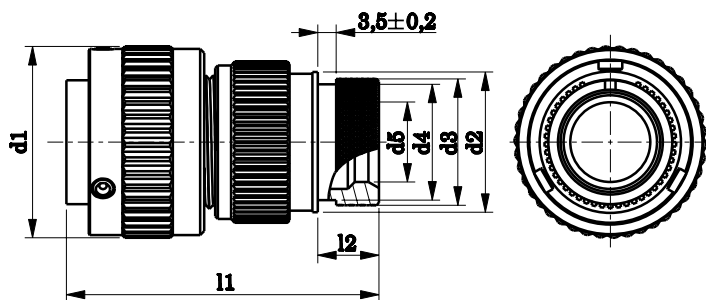

Freier Steckverbinder, gerade, mit 360° HF-Abdichtung durch Massefingerring und Endgehäuse für Formschrumpfteile.  
Free connector, straight type with grounding fingers and backshell for heat shrinkable endshells.  
Mobile droite avec bague de masse et raccord pour pièces thermorétractables.

- Beispiel / Example / Exemple  
 - VG95234T-18-1SN  
 - GCB3106TG-18-1SNB  
 - GCA3106TG-18-1SNB

Gehäusegröße / Shell size / Taille de boîtier	d <sub>1</sub> max.	d <sub>2</sub> ±0,2	d <sub>3</sub> ±0,2	d <sub>4</sub> max.	d <sub>5</sub> min.	l <sub>1</sub> max.	l <sub>2</sub> ±0,5	Masse / Mass g max. <sup>(1)</sup>
10SL	22,8	17,0	15,5	13,3	7,7	50	11,7	26
14S	29,2	20,1	19,1	17,0	10,6	50	11,7	43
16S	32,0	23,5	23,9	21,9	13,5	50	11,7	53
16	32,0	23,5	23,9	21,9	13,5	60	11,5	60
18	36,5	26,5	23,9	21,9	14,6	60	11,5	67
20	39,9	30,2	29,6	26,2	18,7	65	12,7	77
22	43,1	33,6	29,6	26,2	20,8	65	12,7	82
24	46,6	36,1	37,8	34,5	24,6	65	12,7	97
28	53,4	41,4	37,8	34,5	27,0	65	12,7	122
32	60,1	48,6	47,8	43,6	33,3	70	15,2	167
36	66,3	54,8	47,8	43,6	38,5	80	15,2	182

<sup>(1)</sup> Masse ohne Kontakteinsätze / Mass without contact inserts / Masse sans inserts

VG95234 Form U1, U2 / VG95234 Style U1, U2

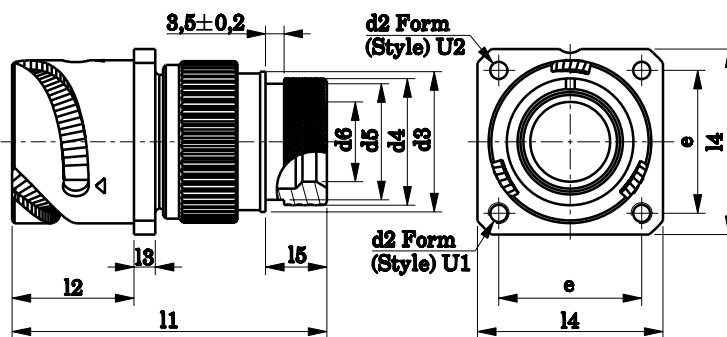

Fester Steckverbinder mit Montageflansch und mit Endgehäuse für Formschrumpfteile. Form U1 mit 4 Gewindebohrungen oder Form U2 mit 4 Durchgangslöchern.  
Fixed connector with mounting flange and backshell for heat shrinkable endshells. Style U1 with 4 threaded holes or style U2 with 4 entry holes.  
Embase à collerette carrée avec raccord pour pièces thermorétractables. Style U1 avec 4 trous taraudés ou U2 avec 4 trous non taraudés.

- Beispiel / Example / Exemple  
 - VG95234U1-18-1SN  
 - GCB3100T-18-1SNB-T2  
 - GCA3100T-18-1SNB-T2  
 - VG95234U2-18-1SN  
 - GCB3100T-18-1SNB  
 - GCA3100T-18-1SNB

Gehäusegröße / Shell size / Taille de boîtier	d <sub>2</sub>		d <sub>3</sub> ±0,2	d <sub>4</sub> ±0,2	d <sub>5</sub> max.	d <sub>6</sub> min.	e ±0,1	l <sub>1</sub> max.	l <sub>2</sub> +0,4	l <sub>3</sub> ±0,2	l <sub>4</sub> ±0,3	l <sub>5</sub> ±0,5	Masse / Mass g max. <sup>(1)</sup>
	Form (Style) U1	Form (Style) U2 H13											
10SL	M4	3,2	17,0	15,5	13,3	7,7	18,2	55	18,2	2,8	25,4	11,7	43
14S	M4	3,2	20,1	19,1	17,0	10,6	23,0	70	18,2	3,2	30,0	11,7	53
16S	M4	3,2	23,5	23,9	21,9	13,5	24,6	70	18,2	3,2	32,5	11,7	63
16	M4	3,2	23,5	23,9	21,9	13,5	24,6	70	23,05	3,2	32,5	11,5	73
18	M4	3,2	26,5	23,9	21,9	14,6	27,0	70	23,05	4,0	35,0	11,5	83
20	M4	3,2	30,2	29,6	26,2	18,7	29,4	70	23,05	4,0	38,0	12,7	93
22	M4	3,2	33,6	29,6	26,2	20,8	31,8	70	23,05	4,0	41,0	12,7	103
24	M4	3,7	36,1	37,8	34,5	24,6	34,9	70	23,05	4,0	44,5	12,7	118
28	M5	3,7	41,4	37,8	34,5	27,0	39,7	70	24,05	4,0	50,8	12,7	148
32	M5	4,3	48,6	47,8	43,6	33,3	44,5	75	24,05	4,0	57,0	15,2	188
36	M5	4,3	54,8	47,8	43,6	38,5	49,2	85	24,05	4,0	63,5	15,2	218

<sup>(1)</sup> Masse ohne Kontakteinsätze / Mass without contact inserts / Masse sans inserts

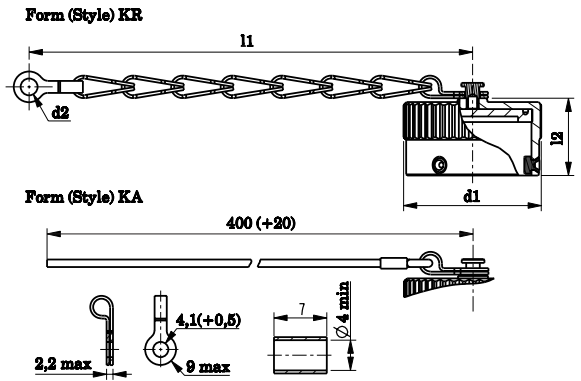

Schutzkappe für Steckdose.  
Form KR mit Kette oder KA mit Seil.  
Protective cover for receptacle.  
Style KR with chain or KA with rope.  
Bouchon pour embase.  
Style KR avec chaîne ou KA avec corde.

Beispiel / Example / Exemple

- VG95234KRXX  
- GCB-KRBXX  
- GCA-KRBXX

- VG95234KAXX  
- GCB-KABXX  
- GCA-KABXX

XX für Gehäusegröße  
XX for shell size  
XX pour la taille de boîtier

Gehäusegröße / Shell size / Taille de boîtier	d <sub>1</sub> max.	d <sub>2</sub> +0,6	l <sub>1</sub> min.	l <sub>2</sub> max.	Masse / Mass g max.
10SL	23,5	4,3	90	20	16
14S	30,5	4,3	90	20	18
16S	33,0	4,3	90	20	19
16	33,0	4,3	100	25	23
18	37,5	4,3	100	25	27
20	41,0	4,3	115	25	30
22	44,0	4,3	115	25	33
24	47,5	4,3	115	25	37
28	54,5	5,5	160	25	42
32	61,0	5,5	160	25	48
36	67,5	5,5	160	25	55

## VG95234 Form KB, KC / VG95234 Style KB, KC

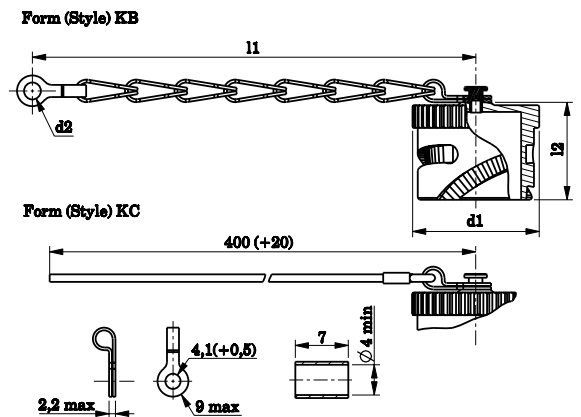

Schutzkappe für Stecker.  
Form KB mit Kette oder KC mit Seil.  
Protective cover for plug shell.  
Style KB with chain or KC with rope.  
Bouchon pour mobile.  
Style KB avec chaîne ou KC avec corde.

Beispiel / Example / Exemple

- VG95234KBXX  
- GCB-KBBXX  
- GCA-KBBXX

- VG95234KCXX  
- GCB-KCBXX  
- GCA-KCBXX

XX für Gehäusegröße  
XX for shell size  
XX pour la taille de boîtier

Gehäusegröße / Shell size / Taille de boîtier	d <sub>1</sub> max.	d <sub>2</sub> +0,6	l <sub>1</sub> min.	l <sub>2</sub> max.	Masse / Mass g max.
10SL	21,0	4,3	90	29	19
14S	27,5	4,3	100	29	26
16S	30,0	4,3	100	29	28
16	30,0	4,3	115	37	33
18	33,5	4,3	115	37	36
20	37,0	4,7	130	37	43
22	40,0	4,7	130	37	47
24	43,5	4,7	130	37	53
28	49,5	4,7	190	37	63
32	56,0	5,5	190	37	75
36	62,5	5,5	190	37	88



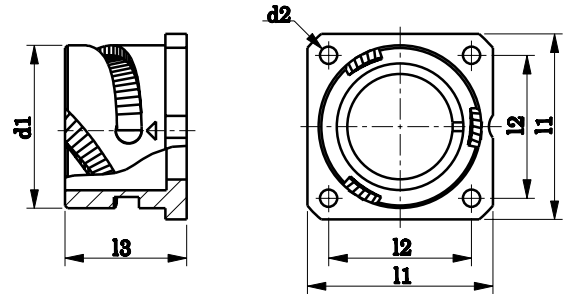

Bliddose, Rückseite offen, für Vorderwandmontage.  
 Dummy, back side open, for front panel mounting.  
 Support de serrage avec face arrière ouverte pour montage de l'avant.

Beispiel / Example / Exemple

- VG95234BODXX
- GCB-BODBXX
- GCA-BODBXX

XX für Gehäusegröße

XX for shell size

XX pour la taille de boîtier

Gehäusegröße / Shell size / Taille de boîtier	d <sub>1</sub> -0,15	d <sub>2</sub> ±0,2	l <sub>1</sub> ±0,3	l <sub>2</sub> ±0,1	l <sub>3</sub> max.	Masse / Mass g max.
10SL	18,2	3,2	25,4	18,2	17,5	14
14S	24,6	3,2	30,0	23,0	18,0	16
16S	27,4	3,2	32,5	24,6	18,0	18
16	27,4	3,2	32,5	24,6	23,5	23
18	30,8	3,2	35,0	27,0	23,5	26
20	34,2	3,2	38,0	29,4	23,5	32
22	37,4	3,2	41,0	31,8	23,5	36
24	40,9	3,7	44,5	34,9	25,5	41
28	46,7	3,7	50,8	39,7	25,5	52
32	53,4	4,3	57,0	44,5	27,0	66
36	59,6	4,3	63,5	49,2	27,0	80

VG95234 Klemme / VG95234 Clamp / VG95234 Porte brides

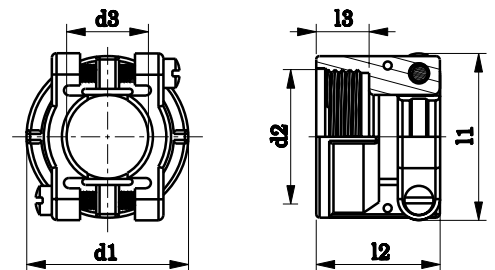

Klemme für Steckverbinder Form E  
 Clamp for connector style E  
 Porte brides pour connecteur style E

Beispiel / Example / Exemple

- VG95234KKXX
- GCB-KKXX
- GCA-KKXX

XX für Gehäusegröße

XX for shell size

XX pour la taille de boîtier

Größe / Size / Taille	Passend für / Appropriate for / Utilisable pour	d <sub>1</sub> ±0,79	d <sub>2</sub> Klasse 2B (Classe 2B, Class 2B)	d <sub>3</sub> max.	l <sub>1</sub> ±0,79	l <sub>2</sub> ±0,79	l <sub>3</sub>	Masse / Mass g max.
4	10SL	20,63	5/8-24UNEF	8	22,23	20,63	10,3	15
6	14S	24,61	3/4-20UNEF	11,2	26,98	22,23	10,3	20
8	16S / 16	27,79	7/8-20UNEF	14,3	29,36	23,83	10,3	25
10	18	30,18	1-20UNEF	15,9	31,75	23,83	10,3	25
12	20 / 22	34,93	1 3/16-18UNEF	19,1	37,31	23,83	10,3	35
16	24 / 28	42,06	1 7/16-18UNEF	23,9	42,88	26,19	10,3	45
20	32	51,59	1 3/4-18UNS	31,8	51,59	27,79	11,9	55
24	36	56,36	2-18UNS	35,0	57,94	29,36	13,5	75



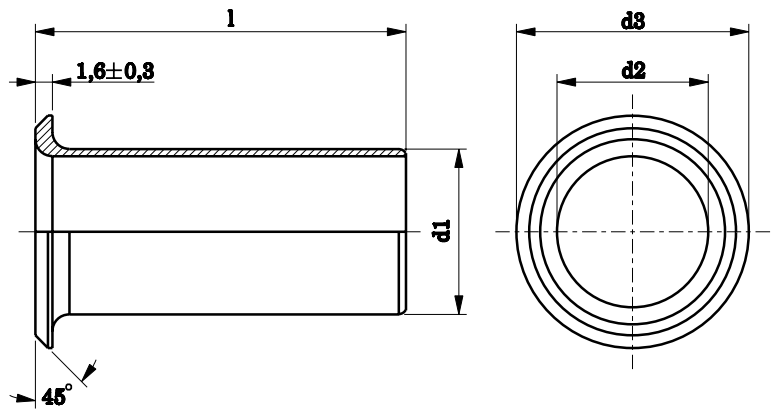

Knickschutztülle.  
Bushings.  
Manchons.

Beispiel / Example / Exemple

- MS3420-10
- GCB-KTXX
- GCA-KTXX

XX für Gehäusegröße

XX for Shell size

XX pour la taille de boîtier

Größe / Size / Taille	Bestell-Nr. nach / Order-No according to / Référence suivant		d <sub>1</sub>	d <sub>2</sub>	d <sub>3</sub>	l	Masse / Mass g max.
	VG95234	MS					
10SL	VG95234KT10SL	-	8,0	6,6	10,0	70,0	3
14S	VG95234KT14S	-	10,9	9,1	12,7	67,0	5
16S / 16	-	MS3420-8	14,0	11,1	18,9	63,5	6
18	-	MS3420-10	15,7	14,3	22,6	60,3	4
20 / 22	-	MS3420-12	18,8	15,9	27,5	57,0	7
24 / 28	VG95234KT24	-	23,6	21,5	33,3	54,0	13
32	VG95234KT32	-	31,5	26,8	40,4	51,0	26
36	-	MS3420-24	34,7	31,8	46,9	47,6	30

## VG95234 Blindstopfen / VG95234 Sealing plug / VG95234 Obturateurs



Kontaktkammern im Dichtkörper, die nicht belegt sind, müssen mit Blindstopfen geschlossen werden.

Technische Daten für GCA-B auf Anfrage, für VG95234 und GCB-B: siehe Tabelle.

Grommet cavities without contacts have to be equipped with sealing plugs.

Technical specifications for GCA-B on request, for VG95234 and GCB-B: see table below.

Les cavités de grommet non câblées doivent être équipées d'obturateurs.

Détails techniques pour GCA-B sur demande, pour VG95234 et GCB-B: voir tableau ci-dessous.

Beispiel / Example / Exemple

- VG95234BXX
- GCB-BXX
- GCA-BXX

XX für Nenngröße, XX for plug size, XX pour la taille

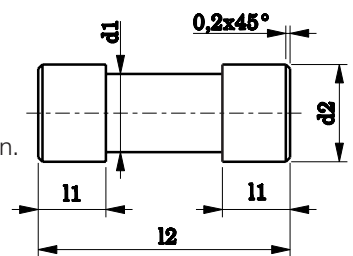

Nenngröße / Plug size / Taille	Für Kontaktgröße / For contact size / Pour contact taille		d <sub>1</sub> ±0,1	d <sub>2</sub> ±0,2	l <sub>1</sub> ±0,1	l <sub>2</sub> ±0,3	Farbe / Color / Couleur	Masse pro 1000 Stück / Mass per 1000 pieces / Masse par 1000 pièces g max.
	Metrisch / Metric / Métrique	AWG						
20	10	-	2,3	3,0	2,4	9,7	rot / red / rouge	70
16	15S / 15	-	2,8	3,7	3,2	11,9	blau / blue / bleu	165
12	25 / 25A	-	3,7	4,6	3,2	11,9	gelb / yellow / jaune	220
8	60 / 100	8	5,0	5,8	3,2	11,9	weiß / white / blanc	330
4	160	4	7,6	8,5	3,2	11,9	grün / green / vert	770
0	500	0	12,8	13,5	3,2	11,9	schwarz / black / noir	2035

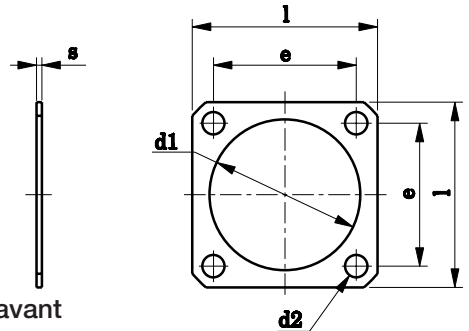
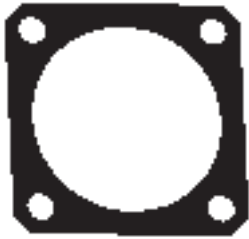

**Für Vorderwandmontage / For front panel mounting / Pour montage de l'avant**

Beispiel / Example / Exemple

- VG95234DAXX-Y

- GCB-DAXX-Y

- GCA-DAXX-Y

XX für Gehäusegröße

XX for Shell size

XX pour la taille de boîtier

Y – 1 für elektrisch nicht leitend / 1 for non conductive /

1 pour non conducteur

2 für elektrisch leitend / 2 for conductive /

2 pour conducteur

Größe / Size / Taille	d <sub>1</sub> +1	d <sub>2</sub> +0,5	e ±0,2	l ±0,5	S		Masse / Mass / g max.
					Ausführung (Version) 1 ±0,4	Ausführung (Version) 2 ±0,2	
10SL	15,7	4,2	18,2	25,4	1	0,5	2
14S	22,1	4,2	23,0	30,0	1	0,5	2
16S / 16	25,3	4,2	24,6	32,5	1	0,5	2
18	28,4	4,2	27,0	35,0	1	0,5	2
20	31,6	4,2	29,4	38,0	1	0,5	2
22	34,8	4,2	31,8	41,0	1	0,5	2
24	38,0	4,2	34,9	44,5	1	0,5	2
28	44,3	5,1	39,7	50,8	1	0,5	2
32	50,7	5,1	44,5	57,0	1	0,5	2
36	57,0	5,1	49,2	63,5	1	0,5	2

**Für Hinterwandmontage / For back panel mounting / Pour montage de l'arrière**

Beispiel / Example / Exemple

- VG95234DHXX-Y

- GCB-DHXX-Y

- GCA-DHXX-Y

XX für Gehäusegröße

XX for Shell size

XX pour la taille de boîtier

Y – 1 für elektrisch nicht leitend / 1 for non conductive /

1 pour non conducteur

2 für elektrisch leitend / 2 for conductive /

2 pour conducteur

Größe / Size / Taille	d <sub>1</sub> +0,3	d <sub>2</sub> +0,5	e ±0,2	l ±0,5	S		Masse / Mass / g max.
					Ausführung (Version) 1 ±0,4	Ausführung (Version) 2 ±0,2	
10SL	18,2	4,2	18,2	25,4	1	0,5	2
14S	24,6	4,2	23,0	30,0	1	0,5	2
16S / 16	27,4	4,2	24,6	32,5	1	0,5	2
18	30,8	4,2	27,0	35,0	1	0,5	2
20	34,2	4,2	29,4	38,0	1	0,5	2
22	37,4	4,2	31,8	41,0	1	0,5	2
24	40,9	4,2	34,9	44,5	1	0,5	2
28	46,7	5,1	39,7	50,8	1	0,5	2
32	53,4	5,1	44,5	57,0	1	0,5	2
36	59,6	5,1	49,2	63,5	1	0,5	2



Fester Steckverbinder mit PG- oder metrischem Endgehäuse ohne Dichtkörper.  
 Modifikation T2 mit 4 Gewindebohrungen.  
 Fixed connector with PG or metrical backshell, without grommet.  
 Modification T2 with 4 threaded holes.  
 Embase à collerette carrée avec raccord PG ou métrique sans grommet.  
 Modification T2 avec 4 trous taraudés.

Beispiel / Example / Exemple  
 - GCB3100PXXX-18-1SNB-T2  
 - GCA3100PXXX-18-10SNB-T2

- GCB3100PXXX-18-1SNB  
 - GCA3100PXXX-18-10SNB

XXX für Gewindetyp  
 XXX for thread type  
 XXX pour le type de taraudage

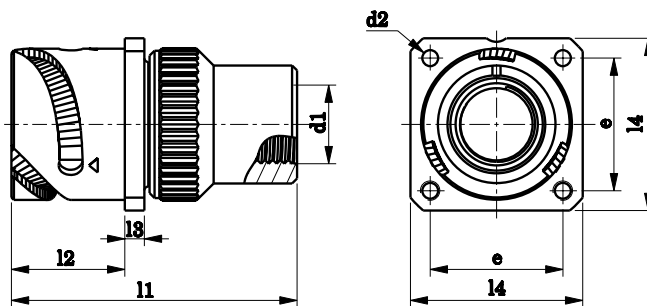

Gehäusegröße / Shell size / Taille de boîtier	d <sub>1</sub> Gewindetyp / Thread type / Type de taraudage				d <sub>2</sub>		l <sub>1</sub> max.	l <sub>2</sub> +0,4	l <sub>3</sub> ±0,2	l <sub>4</sub> ±0,3	e ±0,1
	XXX	PG	XXX	Metrisch / Metrical / Métrique	Ohne / Without / Sans M2	Mit / With / Avec M2					
10SL	G09	PG9	M12	M12x1,5	M4	3,2	55	18,2	2,8	25,4	18,2
14S	G11	PG11	M16	M16x1,5	M4	3,2	55	18,2	3,2	30,0	23,0
16S	G13	PG13,5	M20	M20x1,5	M4	3,2	60	18,2	3,2	32,5	24,6
16	G13	PG13,5	M20	M20x1,5	M4	3,2	70	23,05	3,2	32,5	24,6
18	G13	PG13,5	M20	M20x1,5	M4	3,2	75	23,05	4,0	35,0	27,0
20	G16	PG16	M25	M25x1,5	M4	3,2	75	23,05	4,0	38,0	29,4
22	G16	PG16	M25	M25x1,5	M4	3,2	85	23,05	4,0	41,0	31,8
24	G16	PG16	M25	M25x1,5	M4	3,7	85	23,05	4,0	44,5	34,9
28	G21	PG21	M32	M32x1,5	M5	3,7	90	24,05	4,0	50,8	39,7
32	G29	PG29	M40	M40x1,5	M5	4,3	95	24,05	4,0	57,0	44,5
36	G29	PG29	M40	M40x1,5	M5	4,3	100	24,05	4,0	63,5	49,2

## GCB-B 3101 PG – PM / GCA-B 3101 PG – PM



Kabelverlängerung, gerade, mit PG- oder metrischem Endgehäuse ohne Dichtkörper.  
 Inline receptacle, straight type, with PG or metrical backshell, without grommet.  
 Prolongateur droit avec raccord PG ou métrique, sans grommet.

Beispiel / Example / Exemple  
 - GCB3101PXXX-18-1SNB  
 - GCA3101PXXX-18-10SNB

XXX für Gewindetyp  
 XXX for thread type  
 XXX pour le type de taraudage

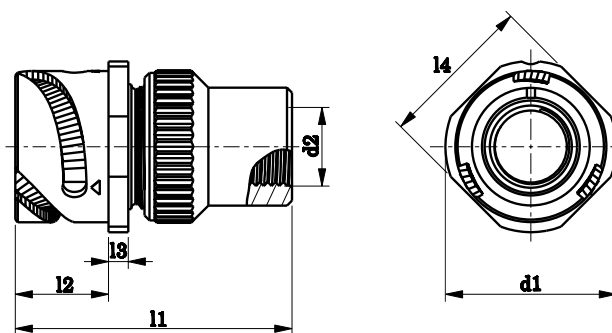

Gehäusegröße / Shell size / Taille de boîtier	d <sub>1</sub> max.	d <sub>2</sub> Gewindegröße / Thread type / Type de taraudage				l <sub>1</sub> max.	l <sub>2</sub> +0,4	l <sub>3</sub> ±0,2	l <sub>4</sub> ±0,2
		XXX	PG	XXX	Metrisch / Metrical / Métrique				
10SL	25,2	G09	PG9	M12	M12x1,5	55	14,2	2,8	20,6
14S	29,8	G11	PG11	M16	M16x1,5	55	14,2	3,2	25,4
16S	32,3	G13	PG13,5	M20	M20x1,5	60	14,2	3,2	28,6
16	32,3	G13	PG13,5	M20	M20x1,5	70	19,0	3,2	28,6
18	34,8	G13	PG13,5	M20	M20x1,5	75	19,0	4,0	31,7
20	37,8	G16	PG16	M25	M25x1,5	75	19,0	4,0	34,9
22	41,1	G16	PG16	M25	M25x1,5	85	19,0	4,0	38,1
24	44,6	G16	PG16	M25	M25x1,5	85	20,6	4,0	41,3
28	50,9	G21	PG21	M32	M32x1,5	90	20,6	4,0	47,6
32	57,1	G29	PG29	M40	M40x1,5	95	22,2	4,0	54,0
36	63,6	G29	PG29	M40	M40x1,5	100	22,0	4,0	60,6

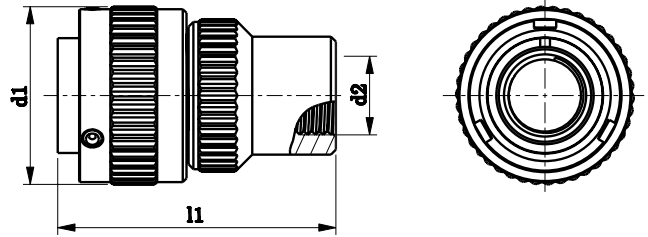

Freier Steckverbinder mit PG- oder metrischem Endgehäuse, ohne Dichtkörper.  
Free connector with PG or metrical backshell, without grommet.  
Mobile droite avec raccord PG ou métrique, sans grommet.

Gehäusegröße / Shell size / Taille de boîtier	d <sub>1</sub> max.	d <sub>2</sub> Gewindetyp / Thread type / Type de taraudage				l <sub>1</sub> max.
		XXX	PG	XXX	Metrisch / Metrical / Métrique	
10SL	22,8	G09	PG9	M12	M12x1,5	55
14S	29,2	G11	PG11	M16	M16x1,5	55
16S	32,0	G13	PG13,5	M20	M20x1,5	60
16	32,0	G13	PG13,5	M20	M20x1,5	70
18	36,5	G13	PG13,5	M20	M20x1,5	75
20	39,9	G16	PG16	M25	M25x1,5	75
22	43,1	G16	PG16	M25	M25x1,5	85
24	46,6	G16	PG16	M25	M25x1,5	85
28	53,4	G21	PG21	M32	M32x1,5	90
32	60,1	G29	PG29	M40	M40x1,5	95
36	66,3	G29	PG29	M40	M40x1,5	100

Beispiel / Example / Exemple  
- GCB3106PXXX-18-1SNB  
- GCA3106PXXX-18-10SNB

XXX für Gewindetyp  
XXX for thread type  
XXX pour le type de taraudage

GCB-B 3107 / GCA-B 3107

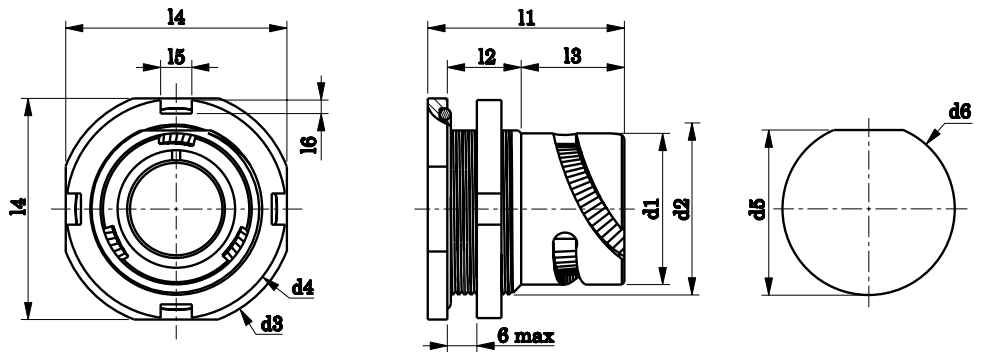

Steckdose für Einlochmontage mit O-Ring Dichtung.  
Receptacle for single hole mounting with O-ring seal.  
Embase à fixation par écrou avec joint torique.

Gehäusegröße / Shell size / Taille de boîtier	d <sub>1</sub>	d <sub>2</sub> Klasse 2A (Class 2A, Classe 2A)	d <sub>3</sub>	d <sub>4</sub>	d <sub>5</sub>	d <sub>6</sub>	l <sub>1</sub>	l <sub>2</sub>	l <sub>3</sub>	l <sub>4</sub>	l <sub>5</sub>	l <sub>6</sub>
10SL	18,2	7/8-20UNEF	35,0	31,5	20,9	22,7	29,2	13,5	12,5	31,8	5,0	2,5
14S	24,6	1 1/8-18UNEF	41,3	37,9	27,2	28,8	29,2	13,5	12,5	38,1	6,0	2,5
16S	27,4	1 1/4-18UNEF	44,4	41,0	30,4	32,0	29,2	13,5	12,5	41,2	6,0	2,5
16	27,4	1 1/4-18UNEF	44,4	41,0	30,4	32,0	37,7	13,5	21,0	41,2	6,0	2,5
18	30,8	1 3/8-18UNEF	48,2	44,8	33,6	35,1	40,0	15,0	21,0	45,0	7,0	3,0
20	34,1	1 1/2-18UNEF	52,4	49,0	36,8	38,2	40,0	15,0	21,0	49,2	7,0	3,0
22	37,3	1 5/8-18UNEF	55,5	52,2	39,9	42,0	40,0	15,0	21,0	52,4	7,0	3,0
24	40,8	1 3/4-18UNEF	59,0	55,0	43,1	44,7	40,0	15,0	21,0	55,2	7,0	3,0
28	46,7	2 –18UNS	66,0	62,0	49,2	51,1	40,0	15,0	21,0	62,2	7,0	3,0
32	53,3	2 1/4-16UN	72,0	68,0	55,7	57,4	40,0	15,0	21,0	68,2	7,0	3,0
36	59,6	2 1/2-16UN	80,0	75,0	62,0	63,8	40,0	15,0	21,0	75,2	8,0	3,0

Beispiel / Example / Exemple  
- GCB3107-18-1SNB  
- GCA3107-18-10SNB

Stiftkontakte VG95234 / GCB-B  
 Pin contacts VG95234 / GCB-B  
 Contacts mâles VG95234 / GCB-B

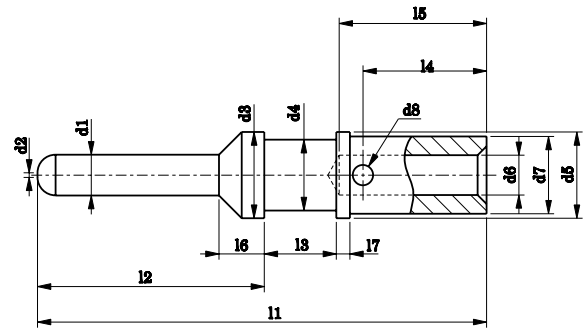

Kontaktgröße / Contact size / Taille de contact		Teile-Nummer / Part-Number / Référence			d <sub>1</sub>	d <sub>2</sub>	d <sub>3</sub>	d <sub>4</sub>	d <sub>5</sub>	d <sub>6</sub>	d <sub>7</sub>
Metrisch / Metrical Métrique	AWG	VG95234	Amphenol versilbert / silver plated / argenté	Amphenol vergoldet / gold plated / doré	-0,05	max.					
10	-	VG95234P10	GCB10M	GCB10M-A176	1,04	0,4	2,0 <sup>-0,05</sup>	1,5 <sup>-0,05</sup>	2,6 <sup>-0,10</sup>	1,50 <sup>+0,05</sup>	2,40 <sup>-0,05</sup>
		VG95234P10-001	GCB10M-001	GCB10M-001-A176						0,90 <sup>+0,05</sup>	
15S	-	VG95234P15S	GCB15SM	GCB15SM-A176	1,60	0,4	3,2 <sup>-0,10</sup>	1,75 <sup>-0,10</sup>	3,2 <sup>-0,10</sup>	1,75 <sup>+0,08</sup>	2,75 <sup>-0,05</sup>
		VG95234P15S-001	GCB15SM-001	GCB15SM-001-A176						0,90 <sup>+0,05</sup>	
		VG95234P15S-002	GCB15SM-002	GCB15SM-002-A176						1,20 <sup>+0,10</sup>	
15	-	VG95234P15	GCB15M	GCB15M-A176	1,60	0,4	3,2 <sup>-0,10</sup>	1,75 <sup>-0,10</sup>	3,2 <sup>-0,10</sup>	1,75 <sup>+0,08</sup>	2,75 <sup>-0,05</sup>
		VG95234P15-001	GCB15M-001	GCB15M-001-A176						0,90 <sup>+0,05</sup>	
		VG95234P15-002	GCB15M-002	GCB15M-002-A176						1,20 <sup>+0,10</sup>	
25	-	VG95234P25	GCB25M	GCB25M-A176	2,40	0,4	4,8 <sup>-0,10</sup>	3,30 <sup>-0,15</sup>	4,8 <sup>-0,10</sup>	2,50 <sup>+0,10</sup>	3,80 <sup>-0,10</sup>
		VG95234P25-001	GCB25M-001	GCB25M-001-A176						1,75 <sup>+0,08</sup>	3,40 <sup>-0,05</sup>
25A	-	VG95234P25A	GCB25AM	GCB25AM-A176	2,40	0,4	4,8 <sup>-0,10</sup>	3,30 <sup>-0,15</sup>	4,8 <sup>-0,10</sup>	2,50 <sup>+0,10</sup>	3,80 <sup>-0,10</sup>
60	-	VG95234P60	GCB60M	GCB60M-A176	3,60	0,4	7,6 <sup>-0,20</sup>	6,25 <sup>-0,15</sup>	7,6 <sup>-0,20</sup>	3,50 <sup>+0,10</sup>	6,80 <sup>-0,10</sup>
		VG95234P60-001	GCB60M-001	GCB60M-001-A176						2,50 <sup>+0,05</sup>	
-	8	VG95234P8	GCB8M	GCB8M-A176	3,60	0,4	7,6 <sup>-0,20</sup>	6,25 <sup>-0,15</sup>	7,6 <sup>-0,20</sup>	4,55 <sup>+0,10</sup>	6,80 <sup>-0,10</sup>
100	-	VG95234P100	GCB100M	GCB100M-A176	3,60	0,4	7,6 <sup>-0,20</sup>	6,25 <sup>-0,15</sup>	7,6 <sup>-0,20</sup>	4,80 <sup>+0,10</sup>	6,80 <sup>-0,10</sup>
160	-	VG95234P160	GCB160M	GCB160M-A176	5,75	2,5	11,2 <sup>-0,20</sup>	9,55 <sup>-0,15</sup>	11,2 <sup>-0,20</sup>	6,20 <sup>+0,15</sup>	9,55 <sup>-0,10</sup>
		VG95234P160-001	GCB160M-001	GCB160M-001-A176						5,70 <sup>+0,10</sup>	
-	4	VG95234P4	GCB4M	GCB4M-A176	5,75	2,5	11,2 <sup>-0,20</sup>	9,55 <sup>-0,15</sup>	11,2 <sup>-0,20</sup>	7,10 <sup>+0,15</sup>	9,55 <sup>-0,10</sup>
500	-	VG95234P500	GCB500M	GCB500M-A176	9,10	5,8	15,15 <sup>-0,20</sup>	13,55 <sup>-0,15</sup>	15,15 <sup>-0,20</sup>	10,70 <sup>+0,15</sup>	14,35 <sup>-0,10</sup>
		VG95234P500-001	GCB500M-001	GCB500M-001-A176						7,60 <sup>+0,15</sup>	
		VG95234P500-002	GCB500M-002	GCB500M-002-A176						9,10 <sup>+0,15</sup>	
-	0	VG95234P0	GCB0M	GCB0M-A176	9,10	5,8	15,15 <sup>-0,20</sup>	13,55 <sup>-0,15</sup>	15,15 <sup>-0,20</sup>	11,50 <sup>+0,15</sup>	14,35 <sup>-0,10</sup>

Kontaktgröße / Contact size / Taille de contact		Teile-Nummer / Part-Number / Référence			d <sub>8</sub>	l <sub>1</sub>	l <sub>2</sub>	l <sub>3</sub>	l <sub>4</sub>	l <sub>5</sub>	l <sub>6</sub>	l <sub>7</sub>
Metrisch / Metrical Métrique	AWG	VG95234	Amphenol versilbert / silver plated / argenté	Amphenol vergoldet / gold plated / doré	±0,1	±0,2	±0,15	±0,1	±0,5	min.		
10	-	VG95234P10	GCB10M	GCB10M-A176	0,7	28,4	11,3	4,75	3,4	4,6	1,3 <sup>±0,10</sup>	0,8 <sup>±0,10</sup>
		VG95234P10-001	GCB10M-001	GCB10M-001-A176								
15S	-	VG95234P15S	GCB15SM	GCB15SM-A176	1,0	27,4	13,9	3,85	5,6	6,8	2,4 <sup>±0,20</sup>	3,2 <sup>±0,20</sup>
		VG95234P15S-001	GCB15SM-001	GCB15SM-001-A176								
		VG95234P15S-002	GCB15SM-002	GCB15SM-002-A176								
15	-	VG95234P15	GCB15M	GCB15M-A176	1,0	31,4	13,9	7,90	5,6	6,8	2,4 <sup>±0,20</sup>	3,2 <sup>±0,20</sup>
		VG95234P15-001	GCB15M-001	GCB15M-001-A176								
		VG95234P15-002	GCB15M-002	GCB15M-002-A176								
25	-	VG95234P25	GCB25M	GCB25M-A176	1,8	37,0	18,3	7,90	5,6	6,8	2,4 <sup>±0,20</sup>	3,8 <sup>±0,20</sup>
		VG95234P25-001	GCB25M-001	GCB25M-001-A176								
25A	-	VG95234P25A	GCB25AM	GCB25AM-A176	1,8	33,9	15,2	7,90	5,6	6,8	2,4 <sup>±0,20</sup>	3,8 <sup>±0,20</sup>
60	-	VG95234P60	GCB60M	GCB60M-A176	1,8	39,6	20,0	6,35	11,0	12,0	4,0 <sup>±0,20</sup>	1,2 <sup>±0,20</sup>
		VG95234P60-001	GCB60M-001	GCB60M-001-A176								
-	8	VG95234P8	GCB8M	GCB8M-A176	1,8	39,6	20,0	6,35	11,0	12,0	4,0 <sup>±0,20</sup>	1,2 <sup>±0,20</sup>
100	-	VG95234P100	GCB100M	GCB100M-A176	1,8	39,6	20,0	6,35	11,0	12,0	4,0 <sup>±0,20</sup>	1,2 <sup>±0,20</sup>
160	-	VG95234P160	GCB160M	GCB160M-A176	1,8	39,6	20,0	6,35	11,0	12,0	4,0 <sup>±0,20</sup>	1,2 <sup>±0,20</sup>
		VG95234P160-001	GCB160M-001	GCB160M-001-A176								
-	4	VG95234P4	GCB4M	GCB4M-A176	1,8	39,6	20,0	6,35	11,0	12,0	4,0 <sup>±0,20</sup>	1,2 <sup>±0,20</sup>
500	-	VG95234P500	GCB500M	GCB500M-A176	1,8	41,0	20,0	6,35	12,3	14,0	4,0 <sup>±0,20</sup>	1,2 <sup>±0,20</sup>
		VG95234P500-001	GCB500M-001	GCB500M-001-A176								
		VG95234P500-002	GCB500M-002	GCB500M-002-A176								
-	0	VG95234P0	GCB0M	GCB0M-A176	1,8	41,0	20,0	6,35	12,3	14,0	4,0 <sup>±0,20</sup>	1,2 <sup>±0,20</sup>

Buchsenkontakte VG95234 / GCB-B  
 Socket contacts VG95234 / GCB-B  
 Contacts femelles VG95234 / GCB-B

Größe / Size / Taille –  
 10; 15S; 15; 25

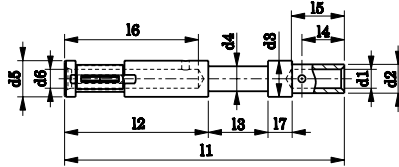

Größe / Size / Taille –  
 60; 8; 100,  
 160; 4; 500; 0

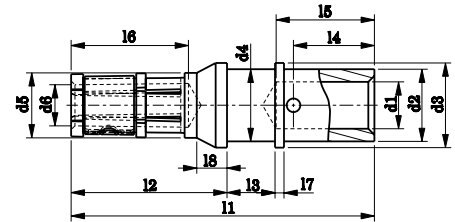

Kontaktgröße / Contact size / Taille de contact		Teile-Nummer / Part-Number / Référence			d <sub>1</sub>	d <sub>2</sub>	d <sub>3</sub>	d <sub>4</sub>	d <sub>5</sub>	d <sub>6</sub>	l <sub>1</sub>
Metrisch / Metrical / Métrique	AWG	VG95234	Amphenol versilbert / silver plated / argenté	Amphenol vergoldet / gold plated / doré							
10	-	VG95234S10	GCB10F	GCB10F-A176	1,50 <sup>+0,05</sup>	2,40 <sup>-0,05</sup>	2,6 <sup>-0,10</sup>	1,50 <sup>-0,05</sup>	2,0 <sup>-0,10</sup>	1,07 <sup>+0,20</sup>	36,8 <sup>±0,30</sup>
		VG95234S10-001	GCB10F-001	GCB10F-001-A176	0,90 <sup>+0,05</sup>						
15S	-	VG95234S15S	GCB15SF	GCB15SF-A176	1,75 <sup>+0,08</sup>	2,75 <sup>-0,05</sup>	3,2 <sup>-0,15</sup>	1,75 <sup>-0,10</sup>	3,2 <sup>-0,15</sup>	1,65 <sup>+0,30</sup>	29,1 <sup>±0,20</sup>
		VG95234S15S-001	GCB15SF-001	GCB15SF-001-A176	0,90 <sup>+0,05</sup>						
		VG95234S15S-002	GCB15SF-002	GCB15SF-002-A176	1,20 <sup>+0,10</sup>						
15	-	VG95234S15	GCB15F	GCB15F-A176	1,75 <sup>+0,08</sup>	2,75 <sup>-0,05</sup>	3,2 <sup>-0,15</sup>	1,75 <sup>-0,10</sup>	3,2 <sup>-0,15</sup>	1,65 <sup>+0,30</sup>	37,8 <sup>±0,20</sup>
		VG95234S15-001	GCB15F-001	GCB15F-001-A176	0,90 <sup>+0,05</sup>						
		VG95234S15-002	GCB15F-002	GCB15F-002-A176	1,20 <sup>+0,10</sup>						
25	-	VG95234S25	GCB25F	GCB25F-A176	2,50 <sup>+0,10</sup>	3,80 <sup>-0,10</sup>	4,8 <sup>-0,10</sup>	3,30 <sup>-0,10</sup>	4,8 <sup>-0,10</sup>	2,45 <sup>+0,30</sup>	37,0 <sup>±0,20</sup>
		VG95234S25-001	GCB25F-001	GCB25F-001-A176	1,75 <sup>+0,08</sup>						
60	-	VG95234S60	GCB60F	GCB60F-A176	3,50 <sup>+0,10</sup>	6,80 <sup>-0,10</sup>	7,6 <sup>-0,20</sup>	6,25 <sup>-0,20</sup>	6,5 <sup>-0,20</sup>	3,65 <sup>±0,05</sup>	40,1 <sup>±0,20</sup>
		VG95234S60-001	GCB60F-001	GCB60F-001-A176	2,50 <sup>+0,05</sup>						
-	8	VG95234S8	GCB8F	GCB8F-A176	4,55 <sup>+0,10</sup>	6,80 <sup>-0,10</sup>	7,6 <sup>-0,20</sup>	6,25 <sup>-0,20</sup>	6,5 <sup>-0,20</sup>	3,65 <sup>±0,05</sup>	40,1 <sup>±0,20</sup>
100	-	VG95234S100	GCB100F	GCB100F-A176	4,80 <sup>+0,10</sup>	6,80 <sup>-0,10</sup>	7,6 <sup>-0,20</sup>	6,25 <sup>-0,20</sup>	6,5 <sup>-0,20</sup>	3,65 <sup>±0,05</sup>	40,1 <sup>±0,20</sup>
160	-	VG95234S160	GCB160F	GCB160F-A176	6,20 <sup>+0,15</sup>	9,55 <sup>-0,10</sup>	11,2 <sup>-0,20</sup>	9,55 <sup>-0,20</sup>	8,6 <sup>-0,20</sup>	5,80 <sup>±0,05</sup>	40,1 <sup>±0,20</sup>
		VG95234S160-001	GCB160F-001	GCB160F-001-A176	5,70 <sup>+0,10</sup>						
-	4	VG95234S4	GCB4F	GCB4F-A176	7,10 <sup>+0,15</sup>	9,55 <sup>-0,10</sup>	11,2 <sup>-0,20</sup>	9,55 <sup>-0,20</sup>	8,6 <sup>-0,20</sup>	5,80 <sup>±0,05</sup>	40,1 <sup>±0,20</sup>
500	-	VG95234S500	GCB500F	GCB500F-A176	10,70 <sup>+0,15</sup>	14,35 <sup>-0,10</sup>	15,15 <sup>-0,20</sup>	13,55 <sup>-0,20</sup>	13,2 <sup>-0,20</sup>	9,15 <sup>±0,05</sup>	41,6 <sup>±0,20</sup>
		VG95234S500-001	GCB500F-001	GCB500F-001-A176	7,60 <sup>+0,15</sup>						
		VG95234S500-002	GCB500F-002	GCB500F-002-A176	9,10 <sup>+0,15</sup>						
-	0	VG95234S0	GCB0F	GCB0F-A176	11,50 <sup>+0,15</sup>	14,35 <sup>-0,10</sup>	15,15 <sup>-0,20</sup>	13,55 <sup>-0,20</sup>	13,2 <sup>-0,20</sup>	9,15 <sup>±0,05</sup>	41,6 <sup>±0,20</sup>

Kontaktgröße / Contact size / Taille de contact		Teile-Nummer / Part-Number / Référence			l <sub>2</sub>	l <sub>3</sub>	l <sub>4</sub>	l <sub>5</sub>	l <sub>6</sub>	l <sub>7</sub>	l <sub>8</sub>
Metrisch / Metrical / Métrique	AWG	VG95234	Amphenol versilbert / silver plated / argenté	Amphenol vergoldet / gold plated / doré	±0,1	±0,5	min.	min.			±0,2
10	-	VG95234S10	GCB10F	GCB10F-A176	19,7 <sup>±0,25</sup>	4,75	3,4	4,6	7,5	0,8 <sup>±0,30</sup>	-
		VG95234S10-001	GCB10F-001	GCB10F-001-A176							
15S	-	VG95234S15S	GCB15SF	GCB15SF-A176	15,1 <sup>±0,20</sup>	3,90	5,6	6,8	10	3,3 <sup>±0,10</sup>	-
		VG95234S15S-001	GCB15SF-001	GCB15SF-001-A176							
		VG95234S15S-002	GCB15SF-002	GCB15SF-002-A176							
15	-	VG95234S15	GCB15F	GCB15F-A176	19,8 <sup>±0,20</sup>	7,90	5,6	6,8	10	3,3 <sup>±0,10</sup>	-
		VG95234S15-001	GCB15F-001	GCB15F-001-A176							
		VG95234S15-002	GCB15F-002	GCB15F-002-A176							
25	-	VG95234S25	GCB25F	GCB25F-A176	19,0 <sup>±0,15</sup>	7,90	5,6	6,8	15	3,2 <sup>±0,20</sup>	-
		VG95234S25-001	GCB25F-001	GCB25F-001-A176							
60	-	VG95234S60	GCB60F	GCB60F-A176	20,6 <sup>±0,15</sup>	6,35	11,0	12,0	15	1,2 <sup>±0,20</sup>	4
		VG95234S60-001	GCB60F-001	GCB60F-001-A176							
-	8	VG95234S8	GCB8F	GCB8F-A176	20,6 <sup>±0,15</sup>	6,35	11,0	12,0	15	1,2 <sup>±0,20</sup>	4
100	-	VG95234S100	GCB100F	GCB100F-A176	20,6 <sup>±0,15</sup>	6,35	11,0	12,0	15	1,2 <sup>±0,20</sup>	4
160	-	VG95234S160	GCB160F	GCB160F-A176	20,6 <sup>±0,15</sup>	6,35	11,0	12,0	15	1,2 <sup>±0,20</sup>	4
		VG95234S160-001	GCB160F-001	GCB160F-001-A176							
-	4	VG95234S4	GCB4F	GCB4F-A176	20,6 <sup>±0,15</sup>	6,35	11,0	12,0	15	1,2 <sup>±0,20</sup>	4
500	-	VG95234S500	GCB500F	GCB500F-A176	20,6 <sup>±0,15</sup>	6,35	12,3	14,0	15	1,2 <sup>±0,20</sup>	4
		VG95234S500-001	GCB500F-001	GCB500F-001-A176							
		VG95234S500-002	GCB500F-002	GCB500F-002-A176							
-	0	VG95234S0	GCB0F	GCB0F-A176	20,6 <sup>±0,15</sup>	6,35	12,3	14,0	15	1,2 <sup>±0,20</sup>	4



Kontaktgröße / Contact size / Taille de contact		Teile-Nummer / Part-Number / Référence			Farbcode / Color code / Code couleur	Anschließbarer Leiter / Applicable wire / Section admissible			
Metrisch / Metrical Métrique	AWG	VG95234 <sup>(1)</sup>	Amphenol versilbert / silver plated / argenté <sup>(2)</sup>	Amphenol vergoldet / gold plated / doré <sup>(2)</sup>		mm <sup>2</sup>		AWG	
						von / for / de	bis / to / à	von / for / de	bis / to / à
10	-	VG95234X10	GCB10X	GCB10X-A176	-	0,50	1,00	20	18
		VG95234X10-001	GCB10X-001	GCB10X-001-A176	Blau / Blue / Bleu	0,14	0,38	26	22
15S	-	VG95234X15S	GCB15SX	GCB15SX-A176	-	0,75	1,50	18	16
		VG95234X15S-001	GCB15SX-001	GCB15SX-001-A176	Blau / Blue / Bleu	0,14	0,38	26	22
		VG95234X15S-002	GCB15SX-002	GCB15SX-002-A176	Rot / Red / Rouge	0,30	0,60	22	20
15	-	VG95234X15	GCB15X	GCB15X-A176	-	0,75	1,50	18	16
		VG95234X15-001	GCB15X-001	GCB15X-001-A176	Blau / Blue / Bleu	0,14	0,38	26	22
		VG95234X15-002	GCB15X-002	GCB15X-002-A176	Rot / Red / Rouge	0,30	0,60	22	20
25	-	VG95234X25	GCB25X	GCB25X-A176	-	2,00	3,00	14	12
		VG95234X25-001	GCB25X-001	GCB25X-001-A176	Schwarz / Black / Noir	0,75	1,50	18	16
25A	-	VG95234P25A	GCB25AM	GCB25AM-A176	-	2,00	3,00	14	12
60	-	VG95234X60	GCB60X	GCB60X-A176	Gelb / Yellow / Jaune	6,00		10	
		VG95234X60-001	GCB60X-001	GCB60X-001-A176	Grün / Green / Vert	2,00	3,00	14	12
-	8	VG95234X8	GCB8X	GCB8X-A176	-	-		8	
100	-	VG95234X100	GCB100X	GCB100X-A176	-	10,0		-	
160	-	VG95234X160	GCB160X	GCB160X-A176	-	16,0		-	
		VG95234X160-001	GCB160X-001	GCB160X-001-A176	Braun / Braun / Brun	-		6	
-	4	VG95234X4	GCB4X	GCB4X-A176	-	-		4	
500	-	VG95234X500	GCB500X	GCB500X-A176	-	50,0		-	
		VG95234X500-001	GCB500X-001	GCB500X-001-A176	Weiss / White / Blanc	25,0		4	
		VG95234X500-002	GCB500X-002	GCB500X-002-A176	Grau / Grey / Gris	35,0		2	
-	0	VG95234X0	GCB0X	GCB0X-A176	-	-		0	

<sup>(1)</sup> X – P oder / or / ou S<sup>(2)</sup> X – M oder / or / ou F

## VG95234 / GCB-B – Werkzeuge / Tools / Outillages

Kontaktgröße / Contact size / Taille de contact		Teile-Nummer / Part-Number Référence			Stiftkontakte / Pin contacts / Contacts mâles		Buchsenkontakte / Socket contacts / Contacts femelles	
Metrisch / Metrical Métrique	AWG	VG95234 <sup>(1)</sup>	Amphenol versilbert / silver plated / argenté <sup>(2)</sup>	Amphenol vergoldet / gold plated / doré <sup>(2)</sup>	Crimpzange / Crimp tool / Pince à sertir	Crimpeinsatz / Crimp insert / Insert à sertir	Crimpzange / Crimp tool / Pince à sertir	Crimpeinsatz / Crimp insert / Insert à sertir
					10	-	VG95234X10	GCB10X
VG95234X10-001	GCB10X-001	GCB10X-001-A176						
15S	-	VG95234X15S	GCB15SX	GCB15SX-A176	M22520/1-01	VG95236T03B001	M22520/1-01	VG95236T03B002
		VG95234X15S-001	GCB15SX-001	GCB15SX-001-A176				
		VG95234X15S-002	GCB15SX-002	GCB15SX-002-A176				
15	-	VG95234X15	GCB15X	GCB15X-A176	M22520/1-01	VG95236T03B001	M22520/1-01	VG95236T03B002
		VG95234X15-001	GCB15X-001	GCB15X-001-A176				
		VG95234X15-002	GCB15X-002	GCB15X-002-A176				
25	-	VG95234X25	GCB25X	GCB25X-A176	M22520/1-01	VG95236T03B001	M22520/1-01	VG95236T03B002
		VG95234X25-001	GCB25X-001	GCB25X-001-A176				
25A	-	VG95234P25A	GCB25AM	GCB25AM-A176	M22520/1-01	VG95236T03B001	-	-
60	-	VG95234X60	GCB60X	GCB60X-A176	VG95236T02A01 oder / or / ou VG95236T02B01 (3)			
		VG95234X60-001	GCB60X-001	GCB60X-001-A176	VG95236T02A01 oder / or / ou VG95236T02B01 (3)			
-	8	VG95234X8	GCB8X	GCB8X-A176	VG95236T02A01 oder / or / ou VG95236T02B01 (3)			
100	-	VG95234X100	GCB100X	GCB100X-A176	VG95236T02A01 oder / or / ou VG95236T02B01 (3)			
160	-	VG95234X160	GCB160X	GCB160X-A176	VG95236T02A02 oder / or / ou VG95236T02B02 (3)			
		VG95234X160-001	GCB160X-001	GCB160X-001-A176	VG95236T02A02 oder / or / ou VG95236T02B02 (3)			
-	4	VG95234X4	GCB4X	GCB4X-A176	VG95236T02A02 oder / or / ou VG95236T02B02 (3)			
500	-	VG95234X500	GCB500X	GCB500X-A176	VG95236T02A03 oder / or / ou VG95236T02B03 (3)			
		VG95234X500-001	GCB500X-001	GCB500X-001-A176	VG95236T02A03 oder / or / ou VG95236T02B03 (3)			
		VG95234X500-002	GCB500X-002	GCB500X-002-A176	VG95236T02A03 oder / or / ou VG95236T02B03 (3)			
-	0	VG95234X0	GCB0X	GCB0X-A176	VG95236T02A03 oder / or / ou VG95236T02B03 (3)			

<sup>(1)</sup> X – P oder / or / ou S<sup>(2)</sup> X – M oder / or / ou F<sup>(3)</sup> A – Hand-Crimpwerkzeug, hydraulisch / Hand crimping tools, hydraulic / Pince à sertir hydraulique manuelle  
B – Crimpkopf, hydraulisch / Crimping head, hydraulic / Tête à sertir hydraulique



Kontakt- einsatz / Contact insert / Insert	Anzahl der Kontakte / Number of contacts / Nombre de contacts	Kontaktgröße / Contact size / Taille de contact					Kontakt- einsatz / Contact insert / Insert	Anzahl der Kontakte / Number of contacts / Nombre de contacts	Kontaktgröße / Contact size / Taille de contact				
		0	4	8	12	16			0	4	8	12	16
14S-4	1					1	36-4	3	3				
16S-3	1					1	14S-2	4					4
16-2	1				1		14S-10	4					4
16-12	1		1				16-9	4				2	2
18-6	1		1				18-4	4					4
18-7	1			1			18-10	4				4	
18-16	1				1		18-13	4			1	3	
22-7	1	1					18-15	4				4	
10SL-4	2					2	20-4	4				4	
14S-9	2					2	20-20	4		1		3	
16S-4	2					2	20-24	4			2		2
16-13	2				2		22-4	4			2	2	
18-3	2				2		22-10	4					4
18-14	2		1			1	22-22	4			4		
20-12	2		1			1	24-22	4			4		
20-23	2			2			36-5	4	4				
22-1	2			2			14S-5	5					5
22-8	2				2		16S-8	5					5
22-11	2					2	18-11	5				5	
24-9	2		2				18-20	5					5
28-7	2		2				18-29	5					5
10SL-3	3					3	18-30	5					5
14S-7	3					3	18-31	5					5
14S-12	3					3	20-14	5			2	3	
16S-5	3					3	22-12	5			2		3
16S-6	3					3	22-13	5				4	1
16-7	3			1		2	22-34	5				3	2
16-10	3				3		24-12	5		2		3	
18-5	3				2	1	24-17	5				2	3
18-22	3					3	28-5	5		2		1	2
20-3	3				3		32-1	5	2			3	
20-6	3					3	14S-6	6					6
20-19	3			3			18-12	6					6
22-2	3			3			20-8	6			2		4
22-6	3			2		1	20-17	6				5	1
22-9	3				3		20-22	6			3		3
22-21	3	1				2	22-5	6				2	4
28-3	3			3			22-15	6				5	1
28-6	3		3				22-24	6				2	4

Kontakt- einsatz / Contact insert / Insert	Anzahl der Kontakte / Number of contacts / Nombre de contacts	Kontaktgröße / Contact size / Taille de contact					Kontakt- einsatz / Contact insert / Insert	Anzahl der Kontakte / Number of contacts / Nombre de contacts	Kontaktgröße / Contact size / Taille de contact						
		0	4	8	12	16			0	4	8	12	16		
28-22	6		3			3	28-8	12				2	10		
36-3	6	3				3	28-9	12				6	6		
36-6	6	2	4				28-18	12					12		
16S-1	7					7	20-11	13					13		
18-9	7					2	20-25	13					13		
18-17	7					2	20-30	13					13		
20-15	7					7	20-27	14					14		
22-28	7					7	22-19	14					14		
22-33	7					7	28-2	14				2	12		
24-2	7					7	28-20	14				10	4		
24-3	7					2	32-4	14				2	12		
24-10	7					7	28-17	15					15		
24-16	7					1	24-5	16					16		
24-27	7						24-7	16				2	14		
28-10	7					2	36-14	16				5	5	6	
18-8	8					1	20-29	17						17	
20-7	8						36-13	17				2		15	
20-9	8					1	22-14	19						19	
22-18	8						28-16	20						20	
22-23	8					8	28-11	22				4		18	
24-6	8					8	36-1	22				4		18	
20-16	9					2	24-28	24						24	
20-18	9					3	28-12	26						26	
20-21	9					1	28-13	26						26	
22-16	9					3	32-8	30				6		24	
22-17	9					1	36-9	31				1	2	14	14
22-20	9						36-18	31				1	2	14	14
22-27	9					1	36-20	34				2	2		30
24-11	9					3	28-15	35							35
28-1	9					3	36-15	35							35
28-4	9					2	28-21	37							37
32-3	9					1	36-7	47						7	40
18-1	10						36-8	47						1	46
18-19	10						36-16	47						7	40
18-24	10						36-17	47						7	40
24-21	10					1	36-10	48							48
28-19	10					4	36-11	48							48
20-33	11						36-12	48							48
24-20	11					2	36-52	52							52

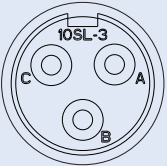
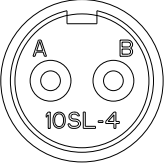
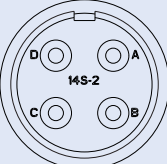
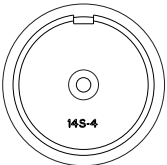
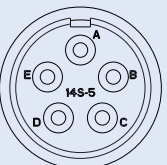
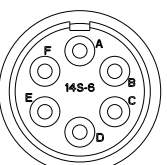
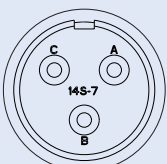
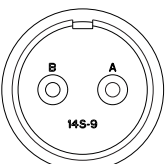
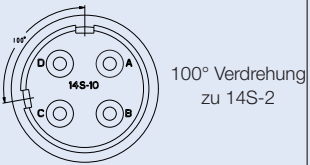
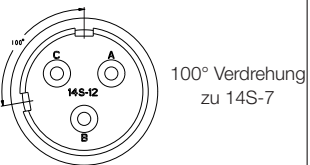
Ansicht auf die Vorderseite des Stifteinsatzes/ Front face of pin insert illustrated/ Vue face avant de l'insert mâle	Polbild / Contact arrangement/ Arrangement	Kontakte / Contacts / Contacts		Spannungsklasse für Kontakte / Voltage class for contacts / Tension d'utilisation des contacts	Winkelstellung der Kontakteinsätze in Grad / Angular position of the contact inserts in degrees / Polarisation des inserts en degrés				
		Anzahl / Number / Nombre	Größe / Size / Taille		N	W	X	Y	Z
	10SL-3	3	AWG 16	A	0	-	-	-	-
	10SL-4	2	AWG 16	A	0	-	-	-	-
	14S-2	4	AWG 16	Inst.	0	-	120	240	-
	14S-4	1	AWG 16	D	0	-	-	-	-
	14S-5	5	AWG 16	Inst.	0	-	110	-	-
	14S-6	6	AWG 16	Inst.	0	-	-	-	-
	14S-7	3	AWG 16	A	0	90	180	270	-
	14S-9	2	AWG 16	A	0	70	145	215	290
 100° Verdrehung zu 14S-2	14S-10	4	AWG 16	Inst.	0	-	-	-	-
 100° Verdrehung zu 14S-7	14S-12	3	AWG 16	A	0	-	-	-	-

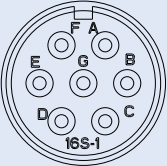
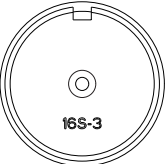
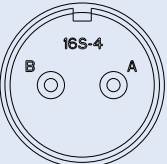
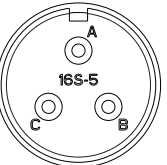
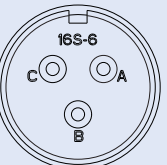
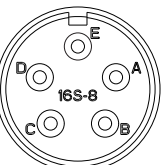
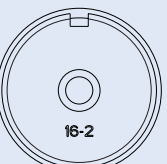
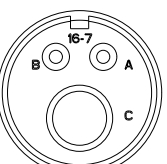
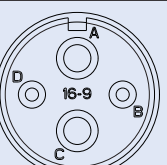
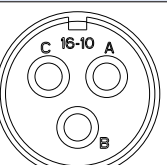
Ansicht auf die Vorderseite des Stifteinsatzes/ Front face of pin insert illustrated/ Vue face avant de l'insert mâle	Polbild / Contact arrangement/ Arrangement	Kontakte / Contacts / Contacts		Spannungsklasse für Kontakte / Voltage class for contacts / Tension d'utilisation des contacts	Winkelstellung der Kontakteinsätze in Grad / Angular position of the contact inserts in degrees / Polarisation des inserts en degrés				
		Anzahl / Number / Nombre	Größe / Size / Taille		N	W	X	Y	Z
	16S-1	7	AWG 16	A	0	80	-	-	280
	16S-3	1	AWG 16	B	0	-	-	-	-
	16S-4	2	AWG 16	D	0	35	110	250	325
	16S-5	3	AWG 16	A	0	70	145	215	290
	16S-6	3	AWG 16	A	0	90	180	270	-
	16S-8	5	AWG 16	A	0	-	170	265	-
	16-2	1	AWG 12	E	0	-	-	-	-
	16-7	1	AWG 8	A	0	80	110	250	280
		2	AWG 16						
	16-9	2	AWG 12	A	0	35	110	250	325
		2	AWG 16						
	16-10	3	AWG 12	A	0	90	180	270	-

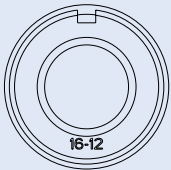
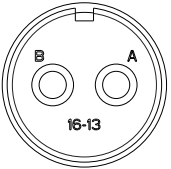
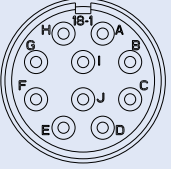
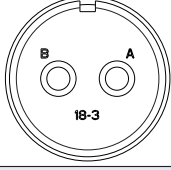
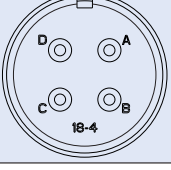
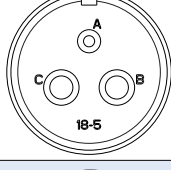
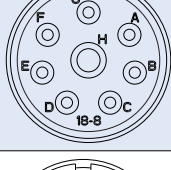

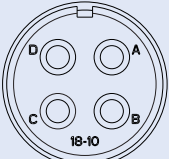
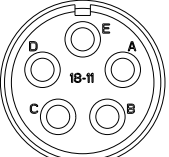
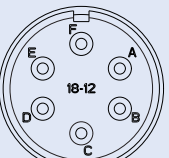
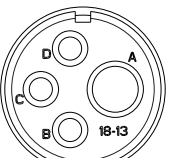
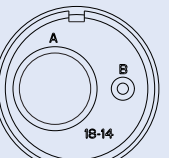
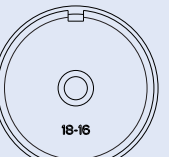
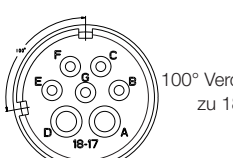
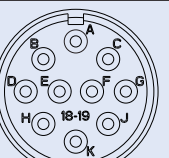
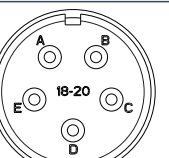
Ansicht auf die Vorderseite des Stifteinsatzes/ Front face of pin insert illustrated/ Vue face avant de l'insert mâle	Polbild / Contact arrangement/ Arrangement	Kontakte / Contacts / Contacts		Spannungsklasse für Kontakte / Voltage class for contacts / Tension d'utilisation des contacts	Winkelstellung der Kontakteinsätze in Grad / Angular position of the contact inserts in degrees / Polarisation des inserts en degrés				
		Anzahl / Number / Nombre	Größe / Size / Taille		N	W	X	Y	Z
	16-12	1	AWG 4	A	0	-	-	-	-
	16-13	2 A = Eisen B = Konstantan	AWG 12	A	0	35	110	250	325
	18-1	10	AWG 16	B,C,F,G - A A,D,E,H,I,J - Inst.	0	70	145	215	290
	18-3	2	AWG 12	D	0	35	110	250	325
	18-4	4	AWG 16	D	0	35	110	250	325
	18-5	2	AWG 12	D	0	80	110	250	280
		1	AWG 16						
	18-6	1	AWG 4	D	0	-	-	-	-
	18-7	1	AWG 8	B	0	-	-	-	-
	18-8	1	AWG 12	A	0	70	-	-	290
		7	AWG 16						
	18-9	2	AWG 12	Inst.	0	80	110	250	280
		5	AWG 16						

Ansicht auf die Vorderseite des Stifteinsatzes/ Front face of pin insert illustrated/ Vue face avant de l'insert mâle	Polbild / Contact arrangement/ Arrangement	Kontakte / Contacts / Contacts		Spannungsklasse für Kontakte / Voltage class for contacts / Tension d'utilisation des contacts	Winkelstellung der Kontakteinsätze in Grad / Angular position of the contact inserts in degrees / Polarisation des inserts en degrés				
		Anzahl / Number / Nombre	Größe / Size / Taille		N	W	X	Y	Z
	18-10	4	AWG 12	A	0	-	120	240	-
	18-11	5	AWG 12	A	0	-	170	265	-
	18-12	6	AWG 16	A	0	80	-	-	280
	18-13	1	AWG 8	A	0	80	110	250	280
		3	AWG 12						
	18-14	1	AWG 4	A	0	80	110	250	280
		1	AWG 16						
	18-15	4	AWG 12	A	0	-	120	240	-
<p>A, C = Eisen B, D = Konstantan</p>									
	18-16	1	AWG 12	C	0	-	-	-	-
	18-17	2	AWG 12	Inst.	0	-	-	-	-
		5	AWG 16						
	18-19	10	AWG 16	A	0	-	-	-	-
	18-20	5	AWG 16	A	0	90	180	270	-

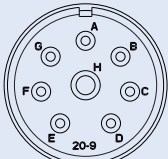
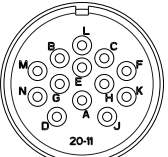
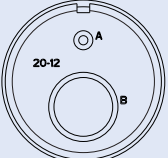
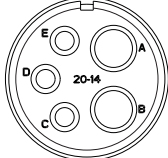
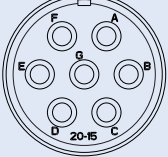
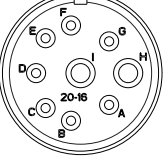
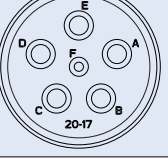
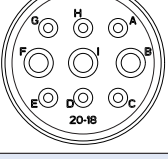
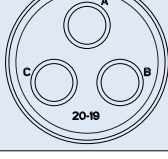
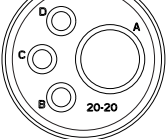

Ansicht auf die Vorderseite des Stifteinsatzes/ Front face of pin insert illustrated/ Vue face avant de l'insert mâle	Polbild / Contact arrangement/ Arrangement	Kontakte / Contacts / Contacts		Spannungsklasse für Kontakte / Voltage class for contacts / Tension d'utilisation des contacts	Winkelstellung der Kontakteinsätze in Grad / Angular position of the contact inserts in degrees / Polarisation des inserts en degrés				
		Anzahl / Number / Nombre	Größe / Size / Taille		N	W	X	Y	Z
	18-22	3	AWG 16	D	0	70	145	215	290
	18-24	10	AWG 16	B,C,F,G - A A,D,E,H,I,J - Inst.	0	-	-	-	-
	18-29	5	AWG 16	A	0	90	180	270	-
	18-30	5	AWG 16	A	0	-	-	-	-
	18-31	5	AWG 16	A	0	-	-	-	-
	20-3	3	AWG 12	D	0	70	145	215	290
	20-4	4	AWG 12	D	0	45	110	250	-
	20-6	3	AWG 16	D	0	70	145	215	290
	20-7	8	AWG 16	A,B,G,H = D C,D,E,F = A	0	80	110	250	280
	20-8	2 4	AWG 8 AWG 16	Inst.	0	80	110	250	280

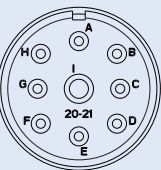
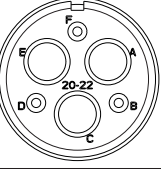
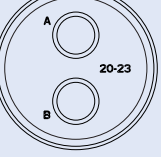
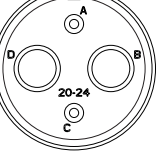
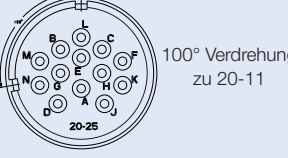
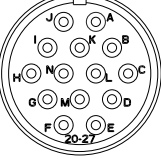
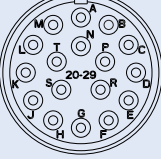
Ansicht auf die Vorderseite des Stifteinsatzes/ Front face of pin insert illustrated/ Vue face avant de l'insert mâle	Polbild / Contact arrangement/ Arrangement	Kontakte / Contacts / Contacts		Spannungsklasse für Kontakte / Voltage class for contacts / Tension d'utilisation des contacts	Winkelstellung der Kontakteinsätze in Grad / Angular position of the contact inserts in degrees / Polarisation des inserts en degrés				
		Anzahl / Number / Nombre	Größe / Size / Taille		N	W	X	Y	Z
	20-9	1	AWG 12	H = D	0	80	110	250	280
		7	AWG 16	A,B,C,D,E,F,G = A					
	20-11	13	AWG 16	Inst.	0	-	-	-	-
	20-12	1	AWG 4	A	0	80	110	250	280
		1	AWG 16						
	20-14	2	AWG 8	A	0	80	110	250	280
		3	AWG 12						
	20-15	7	AWG 12	A	0	80	-	-	280
	20-16	2	AWG 12	A	0	80	110	250	280
		7	AWG 16						
	20-17	5	AWG 12	A	0	90	180	270	-
		1	AWG 16						
	20-18	3	AWG 12	A	0	35	110	250	325
		6	AWG 16						
	20-19	3	AWG 8	A	0	90	180	270	-
	20-20	1	AWG 4	A	0	80	110	250	280
		3	AWG 12						

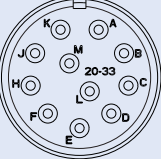
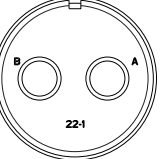
Ansicht auf die Vorderseite des Stifteinsatzes / Front face of pin insert illustrated / Vue face avant de l'insert mâle	Polbild / Contact arrangement / Arrangement	Kontakte / Contacts / Contacts		Spannungsklasse für Kontakte / Voltage class for contacts / Tension d'utilisation des contacts	Winkelstellung der Kontakteinsätze in Grad / Angular position of the contact inserts in degrees / Polarisation des inserts en degrés				
		Anzahl / Number / Nombre	Größe / Size / Taille		N	W	X	Y	Z
	20-21	1	AWG 12	A	0	35	110	250	325
		8	AWG 16						
	20-22	3	AWG 8	A	0	80	110	250	280
		3	AWG 16						
	20-23	2	AWG 8	A	0	35	110	250	325
	20-24	2	AWG 8	A	0	35	110	250	325
		2	AWG 16						
 100° Verdrehung zu 20-11	20-25	13	AWG 16	Inst.	0	-	-	-	-
	20-27	14	AWG 16	A	0	35	110	250	325
	20-29	17	AWG 16	A	0	80	-	-	280
 250° Verdrehung zu 20-11	20-30	13	AWG 16	Inst.	0	-	-	-	-
	20-33	11	AWG 16	A	0	-	-	-	-
	22-1	2	AWG 8	D	0	35	110	250	325

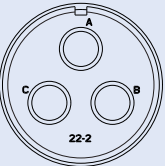
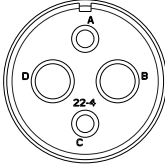
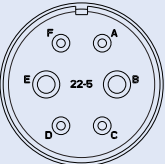
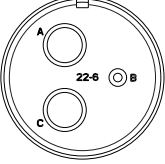
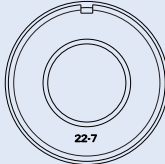
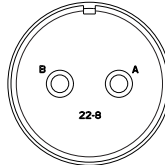
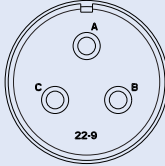
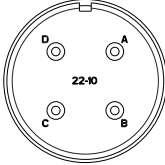
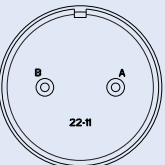
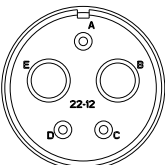
Ansicht auf die Vorderseite des Stifteinsatzes/ Front face of pin insert illustrated/ Vue face avant de l'insert mâle	Polbild / Contact arrangement/ Arrangement	Kontakte / Contacts / Contacts		Spannungsklasse für Kontakte / Voltage class for contacts / Tension d'utilisation des contacts	Winkelstellung der Kontakteinsätze in Grad / Angular position of the contact inserts in degrees / Polarisation des inserts en degrés				
		Anzahl / Number / Nombre	Größe / Size / Taille		N	W	X	Y	Z
	22-2	3	AWG 8	D	0	70	145	215	290
	22-4	2	AWG 8	A	0	35	110	250	325
		2	AWG 12						
	22-5	2	AWG 12	D	0	35	110	250	325
		4	AWG 16						
	22-6	2	AWG 8	D	0	80	110	250	280
		1	AWG 16						
	22-7	1	AWG 0	E	0	-	-	-	-
	22-8	2	AWG 12	E	0	35	110	250	325
	22-9	3	AWG 12	E	0	70	145	215	290
	22-10	4	AWG 16	E	0	35	110	250	325
	22-11	2	AWG 16	B	0	35	110	250	325
	22-12	2	AWG 8	D	0	80	110	250	280
		3	AWG 16						

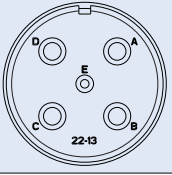
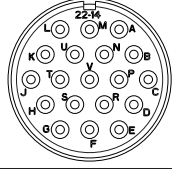
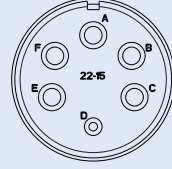
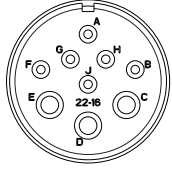
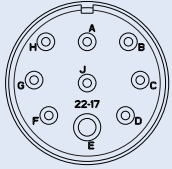
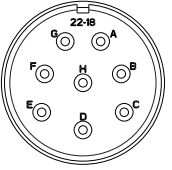
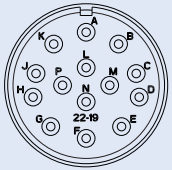
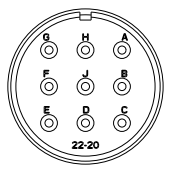
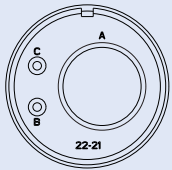
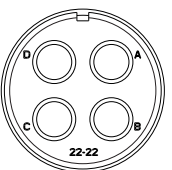

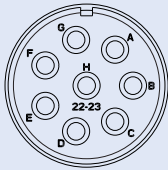
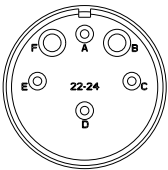
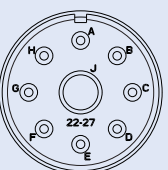
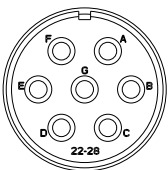
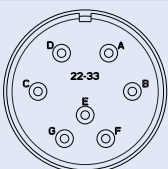
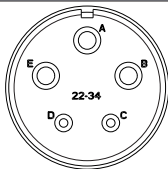
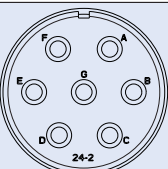
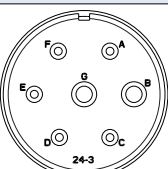
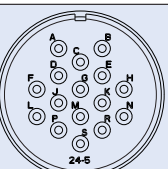
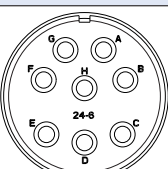
Ansicht auf die Vorderseite des Stifteinsatzes/ Front face of pin insert illustrated/ Vue face avant de l'insert mâle	Polbild / Contact arrangement/ Arrangement	Kontakte / Contacts / Contacts		Spannungsklasse für Kontakte / Voltage class for contacts / Tension d'utilisation des contacts	Winkelstellung der Kontakteinsätze in Grad / Angular position of the contact inserts in degrees / Polarisation des inserts en degrés				
		Anzahl / Number / Nombre	Größe / Size / Taille		N	W	X	Y	Z
	22-13	4	AWG 12	E = D	0	35	110	250	325
		1	AWG 16	A,B,C,D = A					
	22-14	19	AWG 16	A	0	80	110	250	280
	22-15	5	AWG 12	D = E	0	80	110	250	280
		1	AWG 16	A,B,C,E,F = A					
	22-16	3	AWG 12	A	0	80	110	250	280
		6	AWG 16						
	22-17	1	AWG 12	A = D	0	80	110	250	280
		8	AWG 16	B,C,D,E,F,G, H,J = A					
	22-18	8	AWG 16	A,B,F,G,H = D C,D,E = A	0	80	110	250	280
	22-19	14	AWG 16	A	0	80	110	250	280
	22-20	9	AWG 16	A	0	35	110	250	325
	22-21	1	AWG 0	A	0	80	110	250	280
		2	AWG 16						
	22-22	4	AWG 8	A	0	-	110	250	-

Ansicht auf die Vorderseite des Stifteinsatzes/ Front face of pin insert illustrated/ Vue face avant de l'insert mâle	Polbild / Contact arrangement/ Arrangement	Kontakte / Contacts / Contacts		Spannungsklasse für Kontakte / Voltage class for contacts / Tension d'utilisation des contacts	Winkelstellung der Kontakteinsätze in Grad / Angular position of the contact inserts in degrees / Polarisation des inserts en degrés				
		Anzahl / Number / Nombre	Größe / Size / Taille		N	W	X	Y	Z
	22-23	8	AWG 12	H = D  A,B,C,D,E,F,G = A	0	35	-	250	-
	22-24	2	AWG 12	C,D,E = D	0	80	110	250	280
		4	AWG 16	A,B,F = A					
	22-27	1	AWG 8	J = D	0	80	-	250	280
		8	AWG 16	A,B,C,D,E, F,G,H = A					
	22-28	7	AWG 12	A	0	80	-	-	280
	22-33	7	AWG 16	A,B,C,D = D  E,F,G = A	0	80	110	250	280
	22-34	3	AWG 12	D	0	80	110	250	280
		2	AWG 16						
	24-2	7	AWG 12	D	0	80	-	-	280
	24-3	2	AWG 12	D	0	80	110	250	280
		5	AWG 16						
	24-5	16	AWG 16	A	0	80	110	250	280
	24-6	8	AWG 12	A,G,H = D  B,C,D,E,F = A	0	80	110	250	280

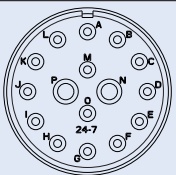
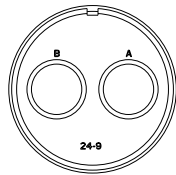
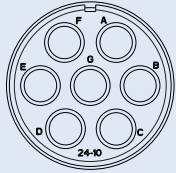
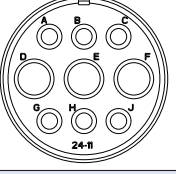
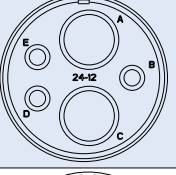
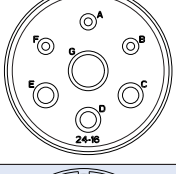
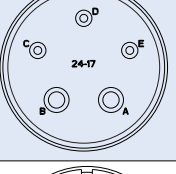
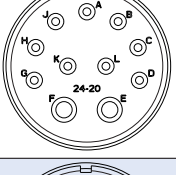
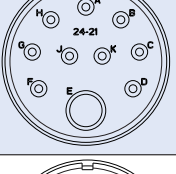
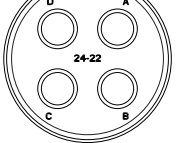

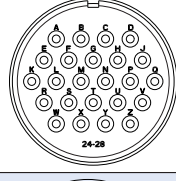
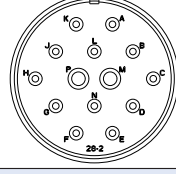
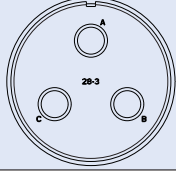
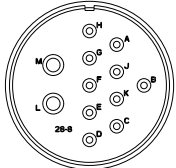
Ansicht auf die Vorderseite des Stifteinsatzes/ Front face of pin insert illustrated/ Vue face avant de l'insert mâle	Polbild / Contact arrangement/ Arrangement	Kontakte / Contacts / Contacts		Spannungsklasse für Kontakte / Voltage class for contacts / Tension d'utilisation des contacts	Winkelstellung der Kontakteinsätze in Grad / Angular position of the contact inserts in degrees / Polarisation des inserts en degrés				
		Anzahl / Number / Nombre	Größe / Size / Taille		N	W	X	Y	Z
	24-7	2	AWG 12	A	0	80	110	250	280
		14	AWG 16						
	24-9	2	AWG 4	A	0	35	110	250	325
	24-10	7	AWG 8	A	0	80	-	-	280
	24-11	3	AWG 8	A	0	35	110	250	325
		6	AWG 12						
	24-12	2	AWG 4	A	0	80	110	250	280
		3	AWG 12						
	24-16	1	AWG 8	A,B,F,G = D C, D, E = A	0	80	110	250	280
		3	AWG 12						
		3	AWG 16						
	24-17	2	AWG 12	D	0	80	110	250	280
		3	AWG 16						
	24-20	2	AWG 12	D	0	80	110	250	280
		9	AWG 16						
	24-21	1	AWG 8	D	0	80	110	250	280
		9	AWG 16						
	24-22	4	AWG 8	D	0	45	110	250	-

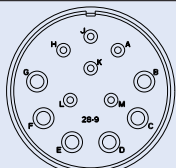
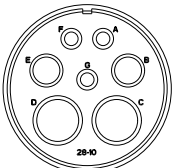
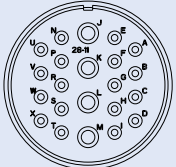
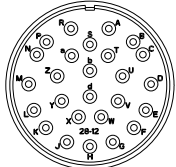
Ansicht auf die Vorderseite des Stifteinsatzes/ Front face of pin insert illustrated/ Vue face avant de l'insert mâle	Polbild / Contact arrangement/ Arrangement	Kontakte / Contacts / Contacts		Spannungsklasse für Kontakte / Voltage class for contacts / Tension d'utilisation des contacts	Winkelstellung der Kontakteinsätze in Grad / Angular position of the contact inserts in degrees / Polarisation des inserts en degrés				
		Anzahl / Number / Nombre	Größe / Size / Taille		N	W	X	Y	Z
	24-27	7	AWG 16	E	0	80	-	-	280
	24-28	24	AWG 16	Inst.	0	80	110	250	280
	28-1	3	AWG 8	A, J, E = D	0	80	110	250	280
		6	AWG 12	B, C, D, F, G, H = A					
	28-2	2	AWG 12	D	0	35	110	250	325
		12	AWG 16						
	28-3	3	AWG 8	E	0	70	145	215	290
	28-4	2	AWG 12	G, S, P = E	0	80	110	250	280
		7	AWG 16	A, B, C, D, E, F = D					
	28-5	2	AWG 4	D	0	35	110	250	325
		1	AWG 12						
		2	AWG 16						
	28-6	3	AWG 4	D	0	70	145	215	290
	28-7	2	AWG 4	D	0	35	110	250	325
	28-8	2	AWG 12	L, M = E B = D	0	80	110	250	280
		10	AWG 16	A, C, D, E, F, G, H, J, K = A					

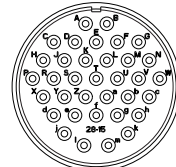
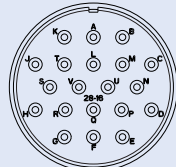
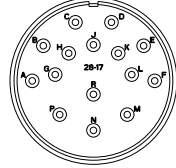
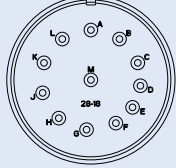
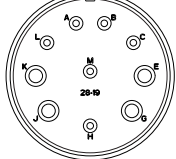
Ansicht auf die Vorderseite des Stifteinsatzes / Front face of pin insert illustrated / Vue face avant de l'insert mâle	Polbild / Contact arrangement / Arrangement	Kontakte / Contacts / Contacts		Spannungsklasse für Kontakte / Voltage class for contacts / Tension d'utilisation des contacts	Winkelstellung der Kontakteinsätze in Grad / Angular position of the contact inserts in degrees / Polarisation des inserts en degrés				
		Anzahl / Number / Nombre	Größe / Size / Taille		N	W	X	Y	Z
	28-9	6	AWG 12	D	0	80	110	250	280
		6	AWG 16						
	28-10	2	AWG 4	G = D A,B,C,D,E,F = A	0	80	110	250	280
		2	AWG 8						
		3	AWG 12						
	28-11	4	AWG 12	A	0	80	110	250	280
		18	AWG 16						
	28-12	26	AWG 16	A	0	90	180	270	-
 100° Verdrehung zu 28-12	28-13	26	AWG 16	A	0	-	-	-	-
	28-15	35	AWG 16	A	0	80	110	250	280
	28-16	20	AWG 16	A	0	80	110	250	280
	28-17	15	AWG 16	R = B M,N,P = D A - L = A	0	80	110	250	280
	28-18	12	AWG 16	M = C G,H,J,K,L = D A, B = A C,D,E,F = Inst.	0	70	145	215	290
	28-19	4	AWG 12	H,M = B A, B = D C,E,G,J,K,L = A	0	80	110	250	280
		6	AWG 16						

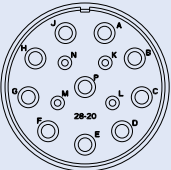
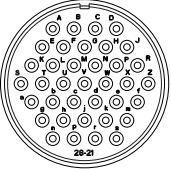
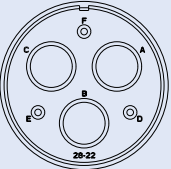
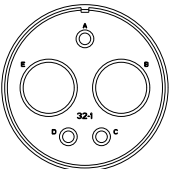
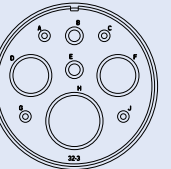
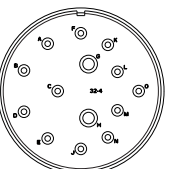
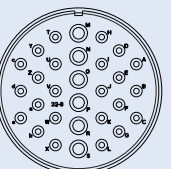
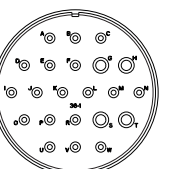
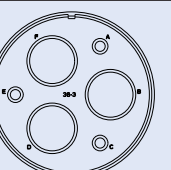
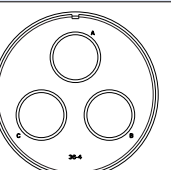
Ansicht auf die Vorderseite des Stifteinsatzes/ Front face of pin insert illustrated/ Vue face avant de l'insert mâle	Polbild / Contact arrangement/ Arrangement	Kontakte / Contacts / Contacts		Spannungsklasse für Kontakte / Voltage class for contacts / Tension d'utilisation des contacts	Winkelstellung der Kontakteinsätze in Grad / Angular position of the contact inserts in degrees / Polarisation des inserts en degrés				
		Anzahl / Number / Nombre	Größe / Size / Taille		N	W	X	Y	Z
	28-20	10	AWG 12	A	0	80	110	250	280
		4	AWG 16						
	28-21	37	AWG 16	A	0	80	110	250	280
	28-22	3	AWG 4	D	0	70	145	215	290
		3	AWG 16						
	32-1	2	AWG 0	A = E B,C,D,E = D	0	80	110	250	280
		3	AWG 12						
	32-3	1	AWG 0	D	0	80	110	250	280
		2	AWG 4						
		2	AWG 12						
		4	AWG 16						
	32-4	2	AWG 12	F,J,K,N = A	0	80	110	250	280
		12	AWG 16	Bal. = D					
	32-8	6	AWG 12	A	0	80	125	235	280
		24	AWG 16						
	36-1	4	AWG 12	D	0	80	110	250	280
		18	AWG 16						
	36-3	3	AWG 0	D	0	70	145	215	290
		3	AWG 12						
	36-4	3	AWG 0	A = D B,C = A	0	70	145	215	290

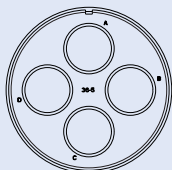
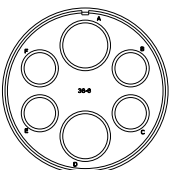
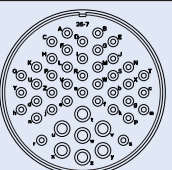
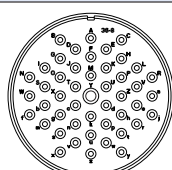
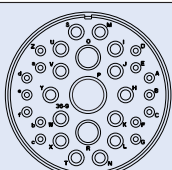
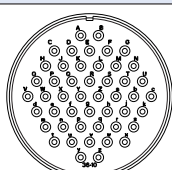
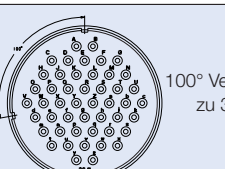
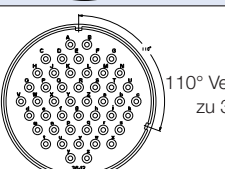
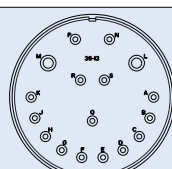
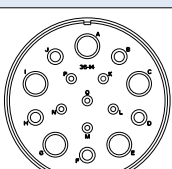
Ansicht auf die Vorderseite des Stifteinsatzes/ Front face of pin insert illustrated/ Vue face avant de l'insert mâle	Polbild / Contact arrangement/ Arrangement	Kontakte / Contacts / Contacts		Spannungsklasse für Kontakte / Voltage class for contacts / Tension d'utilisation des contacts	Winkelstellung der Kontakteinsätze in Grad / Angular position of the contact inserts in degrees / Polarisation des inserts en degrés				
		Anzahl / Number / Nombre	Größe / Size / Taille		N	W	X	Y	Z
	36-5	4	AWG 0	A	0	-	120	240	-
	36-6	2	AWG 0	A	0	35	110	250	325
		4	AWG 4						
	36-7	7	AWG 12	A	0	80	110	250	280
		40	AWG 16						
	36-8	1	AWG 12	A	0	80	110	250	280
		46	AWG 16						
	36-9	1	AWG 4	A	0	80	125	235	280
		2	AWG 8						
		14	AWG 12						
		14	AWG 16						
	36-10	48	AWG 16	A	0	80	125	235	280
 100° Verdrehung zu 36-10	36-11	48	AWG 16	A	0	-	-	-	-
 110° Verdrehung zu 36-10	36-12	48	AWG 16	A	0	-	-	-	-
	36-13	2	AWG 12	N,P,Q = E	0	80	110	250	280
		15	AWG 16	Bal. = A					
	36-14	5	AWG 8	D	0	90	180	270	-
		5	AWG 12						
		6	AWG 16						

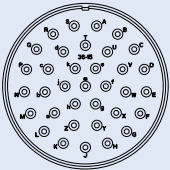
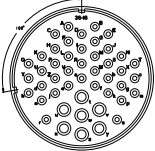
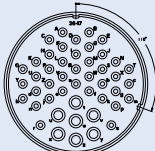
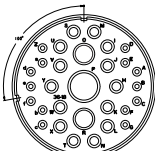
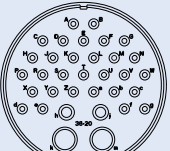
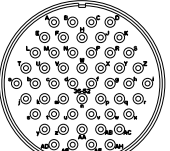
Ansicht auf die Vorderseite des Stifteinsatzes/ Front face of pin insert illustrated/ Vue face avant de l'insert mâle	Polbild / Contact arrangement/ Arrangement	Kontakte / Contacts / Contacts		Spannungsklasse für Kontakte / Voltage class for contacts / Tension d'utilisation des contacts	Winkelstellung der Kontakteinsätze in Grad / Angular position of the contact inserts in degrees / Polarisation des inserts en degrés				
		Anzahl / Number / Nombre	Größe / Size / Taille		N	W	X	Y	Z
	36-15	35	AWG 16	M = D  Bal. = A	0	60	125	245	305
 100° Verdrehung zu 36-7	36-16	7	AWG 12	A	0	-	-	-	-
		40	AWG 16						
 100° Verdrehung zu 36-7	36-17	7	AWG 12	A	0	-	-	-	-
		40	AWG 16						
 100° Verdrehung zu 36-9	36-18	1	AWG 4	A	0	-	-	-	-
		2	AWG 8						
		14	AWG 12						
		14	AWG 16						
	36-20	2	AWG 8	A	0	-	-	-	-
		2	AWG 12						
		30	AWG 16						
	36-52	52	AWG 16	A	0	-	-	-	-

## GCA-B – Werkzeuge / Tools / Outillages

Kontaktgröße / Contact size / Taille de contact	Stiftkontakte / Pin contacts / Contacts mâles		Buchsenkontakte / Socket contacts / Contacts femelles	
	Crimpzange / Crimp tool / Pince à sertir	Crimpeinsatz / Crimp insert / Insert à sertir	Crimpzange / Crimp tool / Pince à sertir	Crimpeinsatz / Crimp insert / Insert à sertir
AWG				
16S	M22520/1-01	M22520/1-05	M22520/1-01	M22520/1-05
16	M22520/1-01	M22520/1-05	M22520/1-01	M22520/1-05
12	M22520/1-01	M22520/1-05	M22520/1-01	M22520/1-05
8	VG95236T02A01 oder / or / ou VG95236T02B01 <sup>(3)</sup>			
4	VG95236T02A02 oder / or / ou VG95236T02B02 <sup>(3)</sup>			
0	VG95236T02A03 oder / or / ou VG95236T02B03 <sup>(3)</sup>			

<sup>(3)</sup> A – Hand-Crimpwerkzeug, hydraulisch / Hand crimping tools, hydraulic / Pince à sertir hydraulique manuelle  
B – Crimpkopf, hydraulisch / Crimping head, hydraulic / Tête à sertir hydraulique



Stiftkontakte GCA-B  
 Pin contacts GCA-B  
 Contacts mâles GCA-B

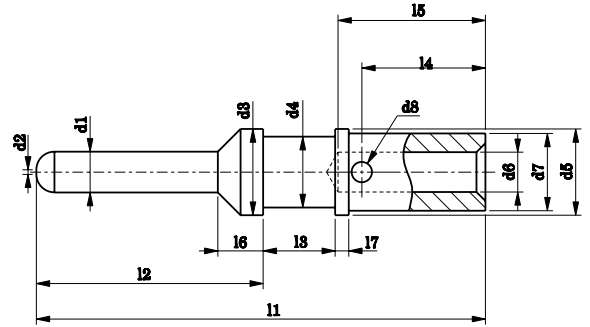

Kontaktgröße / Contact size / Taille de contact	Teile-Nummer Part-Number Référence		Anschließerbarer Leiter / Applicable wire / Section admissible		$d_1$	$d_2$ max.	$d_3$	$d_4$	$d_5$	$d_6$	$d_7$
	AWG	versilbert / silver plated / argenté	vergoldet / gold plated / doré	AWG							
16S	GCA16SM	GCA16SM-A176	18-16	0,75-1,50	1,61 $\pm 0,05$	0,40	3,10 $\pm 0,03$	1,70 $\pm 0,02$	3,10 $\pm 0,03$	1,72 $\pm 0,03$	2,65 $\pm 0,05$
	GCA16SM-001	GCA16SM-001-A176	26-22	0,14-0,38						0,90 $\pm 0,05$	
	GCA16SM-002	GCA16SM-002-A176	22-20	0,30-0,60						1,20 $\pm 0,10$	
16	GCA16M	GCA16M-A176	18-16	0,75-1,50	1,61 $\pm 0,05$	0,40	3,10 $\pm 0,03$	1,70 $\pm 0,02$	3,10 $\pm 0,03$	1,72 $\pm 0,03$	2,65 $\pm 0,05$
	GCA16M-001	GCA16M-001-A176	26-22	0,14-0,38						0,90 $\pm 0,05$	
	GCA16M-002	GCA16M-002-A176	22-20	0,30-0,60						1,20 $\pm 0,10$	
12	GCA12M	GCA12M-A176	14-12	2,00-3,00	2,39 $\pm 0,02$	0,40	4,78 $\pm 0,08$	3,10 $\pm 0,03$	4,78 $\pm 0,08$	2,50 $\pm 0,10$	3,96 $\pm 0,10$
	GCA12M-001	GCA12M-001-A176	18-16	0,75-1,50						1,75 $\pm 0,08$	
8	GCA8M	GCA8M-A176	8	-	3,60 $\pm 0,03$	0,40	7,95 $\pm 0,08$	6,10 $\pm 0,05$	7,95 $\pm 0,08$	5,20 $\pm 0,10$	6,40 $\pm 0,10$
	GCA8M-001	GCA8M-001-A176	10	6,0						3,50 $\pm 0,10$	
	GCA8M-002	GCA8M-002-A176	-	10						4,80 $\pm 0,10$	
	GCA8M-003	GCA8M-003-A176	14-12	2,00-3,00						2,50 $\pm 0,10$	
4	GCA4M	GCA4M-A176	4	-	5,70 $\pm 0,03$	2,50	11,15 $\pm 0,05$	9,65 $\pm 0,05$	11,15 $\pm 0,05$	7,10 $\pm 0,15$	9,50 $\pm 0,10$
	GCA4M-001	GCA4M-001-A176	-	16						6,20 $\pm 0,15$	
	GCA4M-002	GCA4M-002-A176	6	-						5,70 $\pm 0,10$	
0	GCA0M	GCA0M-A176	0	-	9,05 $\pm 0,02$	5,80	15,00 $\pm 0,08$	13,49 $\pm 0,08$	15,00 $\pm 0,05$	11,50 $\pm 0,15$	14,35 $\pm 0,10$
	GCA0M-001	GCA0M-001-A176	-	50						10,70 $\pm 0,15$	
	GCA0M-002	GCA0M-002-A176	4	25						7,60 $\pm 0,15$	
	GCA0M-003	GCA0M-003-A176	2	35						9,10 $\pm 0,15$	

Kontaktgröße / Contact size / Taille de contact	Teile-Nummer Part-Number Référence		Anschließerbarer Leiter / Applicable wire / Section admissible		$d_8$	$l_1$	$l_2$	$l_3$	$l_4$	$l_5$	$l_6$	$l_7$
	AWG	versilbert / silver plated / argenté	vergoldet / gold plated / doré	AWG								
16S	GCA16SM	GCA16SM-A176	18-16	0,75-1,50	0,8	26,43	15,93	3,95	5,4	6,60	3,12	0,80
	GCA16SM-001	GCA16SM-001-A176	26-22	0,14-0,38								
	GCA16SM-002	GCA16SM-002-A176	22-20	0,30-0,60								
16	GCA16M	GCA16M-A176	18-16	0,75-1,50	0,8	30,43	15,93	5,95	5,4	6,60	3,12	0,80
	GCA16M-001	GCA16M-001-A176	26-22	0,14-0,38								
	GCA16M-002	GCA16M-002-A176	22-20	0,30-0,60								
12	GCA12M	GCA12M-A176	14-12	2,00-3,00	0,9	36,60	19,73	6,22	5,5	6,35	3,45	0,80
	GCA12M-001	GCA12M-001-A176	18-16	0,75-1,50								
8	GCA8M	GCA8M-A176	8	-	0,9	36,60	19,73	6,22	11,0	12,70	3,45	1,50
	GCA8M-001	GCA8M-001-A176	10	6,0								
	GCA8M-002	GCA8M-002-A176	-	10								
	GCA8M-003	GCA8M-003-A176	14-12	2,00-3,00								
4	GCA4M	GCA4M-A176	4	-	0,8	34,90	20,85	6,22	11,0	15,00	5,75	1,50
	GCA4M-001	GCA4M-001-A176	-	16								
	GCA4M-002	GCA4M-002-A176	6	-								
0	GCA0M	GCA0M-A176	0	-	1,8	44,45	24,20	5,70	12,3	15,90	6,75	0,80
	GCA0M-001	GCA0M-001-A176	-	50								
	GCA0M-002	GCA0M-002-A176	4	25								
	GCA0M-003	GCA0M-003-A176	2	35								

Buchsenkontakte GCA-B  
Socket contacts GCA-B  
Contacts femelles GCA-B

Größe / Size / Taille –  
8

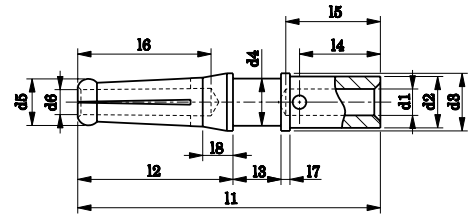

Größe / Size / Taille –  
16S; 16; 12

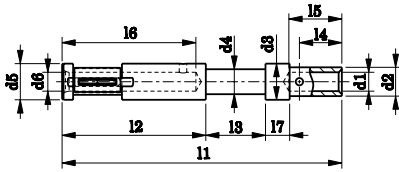

Größe / Size / Taille –  
4; 0

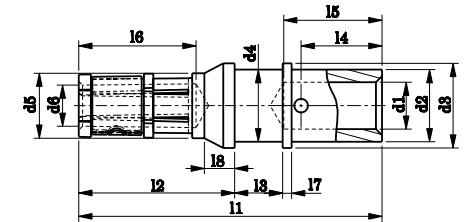

Kontaktgröße / Contact size / Taille de contact	Teile-Nummer Part-Number Référence		Anschließbarer Leiter / Applicable wire / Section admissible		d <sub>1</sub>	d <sub>2</sub>	d <sub>3</sub>	d <sub>4</sub>	d <sub>5</sub>	d <sub>6</sub> ±0,05	l <sub>1</sub> ±0,2
	versilbert / silver plated / argenté	vergoldet / gold plated / doré	AWG	mm <sup>2</sup>							
16S	GCA16SF	GCA16SF-A176	18-16	0,75-1,50	1,72 ±0,03	2,65 ±0,05	3,18 ±0,03	2,08 ±0,03	3,18 ±0,03	1,73	29,1
	GCA16SF-001	GCA16SF-001-A176	26-22	0,14-0,38	0,90 ±0,05						
	GCA16SF-002	GCA16SF-002-A176	22-20	0,30-0,60	1,20 ±0,10						
16	GCA16F	GCA16F-A176	18-16	0,75-1,50	1,72 ±0,03	2,65 ±0,05	3,18 ±0,03	2,08 ±0,03	3,18 ±0,03	1,73	34,1
	GCA16F-001	GCA16F-001-A176	26-22	0,14-0,38	0,90 ±0,05						
	GCA16F-002	GCA16F-002-A176	22-20	0,30-0,60	1,20 ±0,10						
12	GCA12F	GCA12F-A176	14-12	2,00-3,00	2,50 ±0,10	3,96 ±0,10	4,78 ±0,08	3,10 ±0,03	4,32 ±0,05	2,51	36,9
	GCA12F-001	GCA12F-001-A176	18-16	0,75-1,50	1,75 ±0,08						
8	GCA8F	GCA8F-A176	8	-	5,20 ±0,10	6,40 ±0,10	7,95 ±0,05	6,10 ±0,05	7,95 ±0,05	3,75	36,9
	GCA8F-001	GCA8F-001-A176	10	6,0	3,50 ±0,10						
	GCA8F-002	GCA8F-002-A176	-	10	4,80 ±0,10						
	GCA8F-003	GCA8F-003-A176	14-12	2,00-3,00	2,50 ±0,10						
4	GCA4F	GCA4F-A176	4	-	7,10 ±0,15	9,50 ±0,10	11,15 ±0,05	9,65 ±0,05	8,80 ±0,05	5,40	39,75
	GCA4F-001	GCA4F-001-A176	-	16	6,20 ±0,15						
	GCA4F-002	GCA4F-002-A176	6	-	5,70 ±0,10						
0	GCA0F	GCA0F-A176	0	-	11,50 ±0,15	14,35 ±0,10	15,00 ±0,08	13,49 ±0,08	15,00 ±0,08	9,20	44,45
	GCA0F-001	GCA0F-001-A176	-	50	10,70 ±0,15						
	GCA0F-002	GCA0F-002-A176	4	25	7,60 ±0,15						
	GCA0F-003	GCA0F-003-A176	2	35	9,10 ±0,15						

Kontaktgröße / Contact size / Taille de contact	Teile-Nummer Part-Number Référence		Anschließbarer Leiter / Applicable wire / Section admissible		l <sub>2</sub> ±0,1	l <sub>3</sub> ±0,1	l <sub>4</sub> ±0,1	l <sub>5</sub> min.	l <sub>6</sub> min.	l <sub>7</sub> ±0,1	l <sub>8</sub> ±0,1
	versilbert / silver plated / argenté	vergoldet / gold plated / doré	AWG	mm <sup>2</sup>							
16S	GCA16SF	GCA16SF-A176	18-16	0,75-1,50	15,10	3,90	5,50	6,60	10,0	3,30	-
	GCA16SF-001	GCA16SF-001-A176	26-22	0,14-0,38							
	GCA16SF-002	GCA16SF-002-A176	22-20	0,30-0,60							
16	GCA16F	GCA16F-A176	18-16	0,75-1,50	22,40	3,18	5,50	6,60	16,1	0,80	-
	GCA16F-001	GCA16F-001-A176	26-22	0,14-0,38							
	GCA16F-002	GCA16F-002-A176	22-20	0,30-0,60							
12	GCA12F	GCA12F-A176	14-12	2,00-3,00	20,04	6,22	5,55	6,35	17,6	0,80	-
	GCA12F-001	GCA12F-001-A176	18-16	0,75-1,50							
8	GCA8F	GCA8F-A176	8	-	20,04	6,22	11,0	12,70	17,6	1,50	4,50
	GCA8F-001	GCA8F-001-A176	10	6,0							
	GCA8F-002	GCA8F-002-A176	-	10							
	GCA8F-003	GCA8F-003-A176	14-12	2,00-3,00							
4	GCA4F	GCA4F-A176	4	-	20,50	5,70	11,0	15,00	15,0	0,85	5,60
	GCA4F-001	GCA4F-001-A176	-	16							
	GCA4F-002	GCA4F-002-A176	6	-							
0	GCA0F	GCA0F-A176	0	-	24,20	5,70	12,3	15,90	21,2	0,80	2,40
	GCA0F-001	GCA0F-001-A176	-	50							
	GCA0F-002	GCA0F-002-A176	4	25							
	GCA0F-003	GCA0F-003-A176	2	35							

Amphenol-Air LB GmbH · Am Kleinbahnhof 4 · D-66740 Saarlouis  
Telefon +49 (0) 68 31 98 10 -0 · Telefax +49 (0) 68 31 98 10 -20 · E-mail: [info@amphenol-airlb.de](mailto:info@amphenol-airlb.de)  
<http://www.amphenol-airlb.de>