

FX2M6 Series

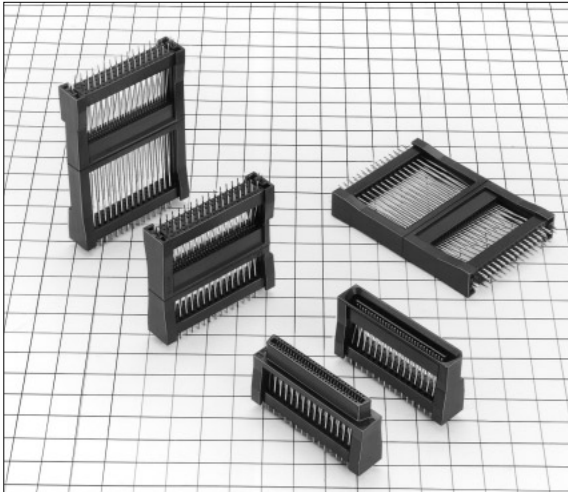

Ordering Information

FX2M6 **A** - **60** **P** - **1.27** **DSA** **L**
 ① ② ③ ④ ⑤ ⑥ ⑦

① Series Name	: FX2M6
② Type No.	: A
③ Number of contacts	: 60
④ Contact Style	
P	: Header
S	: Receptacle
⑤ Contact pitch	: 1.27mm
⑥ DSA	: Straight type
⑦ L	: Board prefixed pin

Stacking Variation

Unit: mm

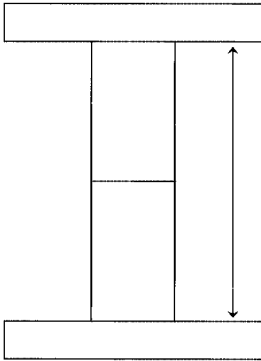

Header \ Receptacle	FX2C-60S -1.27DSA	FX2C2-60S -1.27DSA	FX2M6B-60S -1.27DSAL	FX2M6A-60S -1.27DSAL
FX2C-60P -1.27DSA	12	14	28.2	44.2
FX2C1-60P -1.27DSA	13	15	29.2 *2	45.2 *2
FX2C2-60P -1.27DSA	14	16	30.2 *2	46.2 *2
FX2M6B-60P -1.27DSAL	28.4 *1	30.4 *1	44	60
FX2M6A-60P -1.27DSAL	34.4 *1	36.4 *1	50	66

Note 1. Mate the male and female connectors to meet the allowable clearance within 1.0mm. However, set it within 0.4mm in combination *1.

Note 2. In case of combination *2, 0.6mm clearance occurs on the mating side, but no problem.

Note 3. After the board is mounted, fix the board by screws.

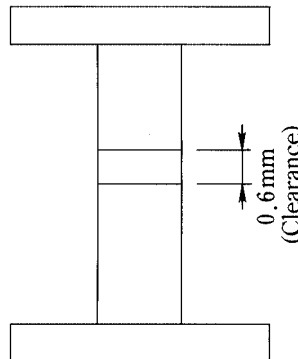

Header

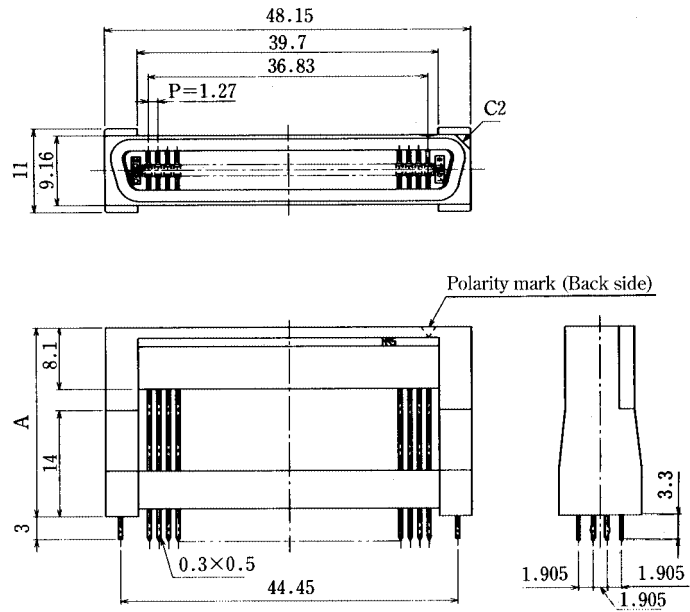
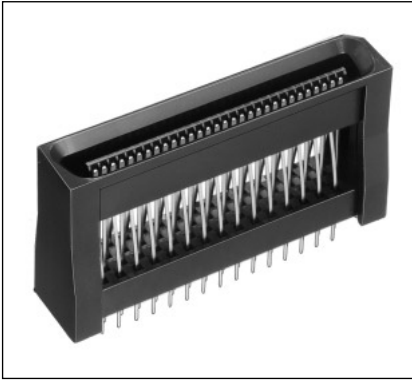

PCB mounting pattern

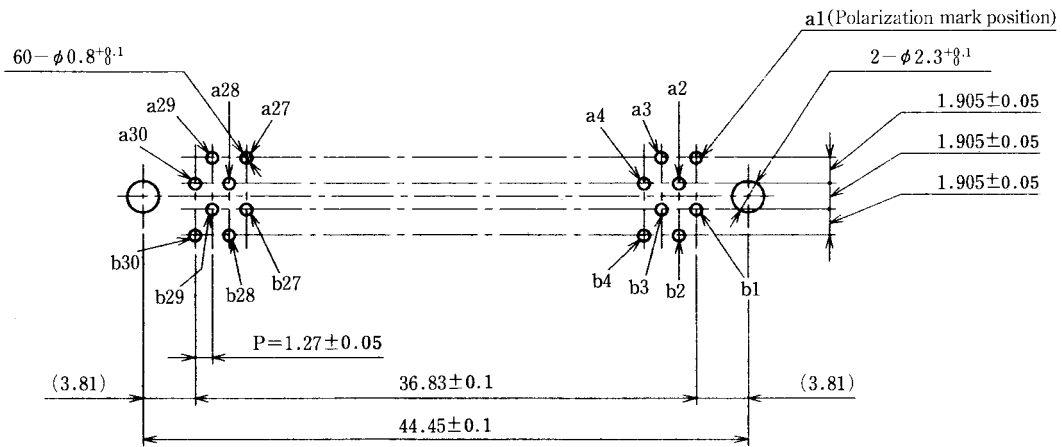

Applicable board thickness $t = 1.6$

Unit: mm

Part Number	CL No.	A
FX2M6A-60P-1.27DSAL	572-1036-8	30.9
FX2M6B-60P-1.27DSAL	572-1041-8	24.9

◆ Connection Circuit Diagram

$$n = \frac{\text{Number of Contacts}}{2}$$

Type A, B

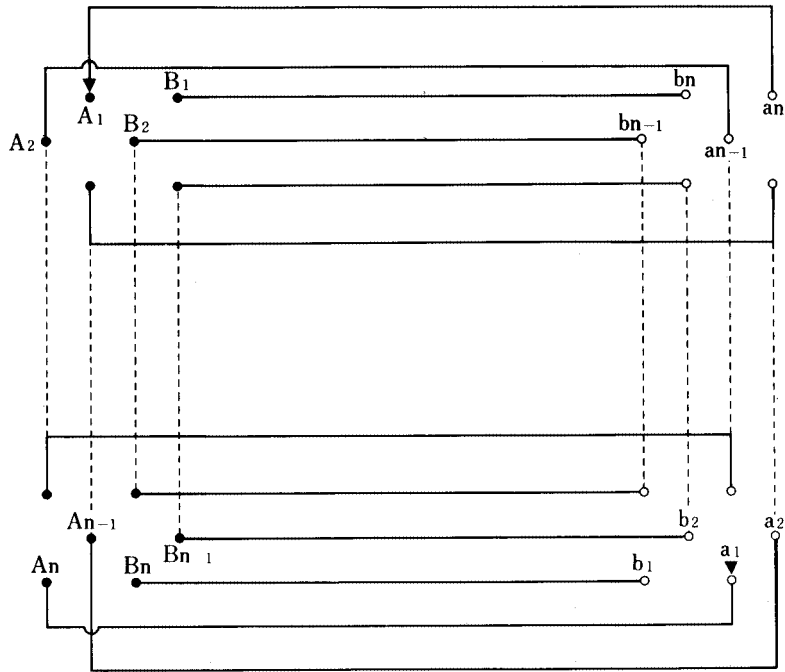
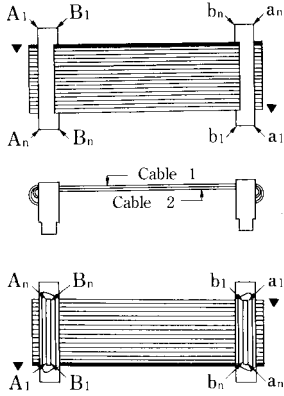

Connection to Cable 1

Connection to Cable 2

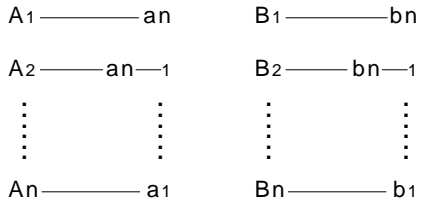

Type A, A

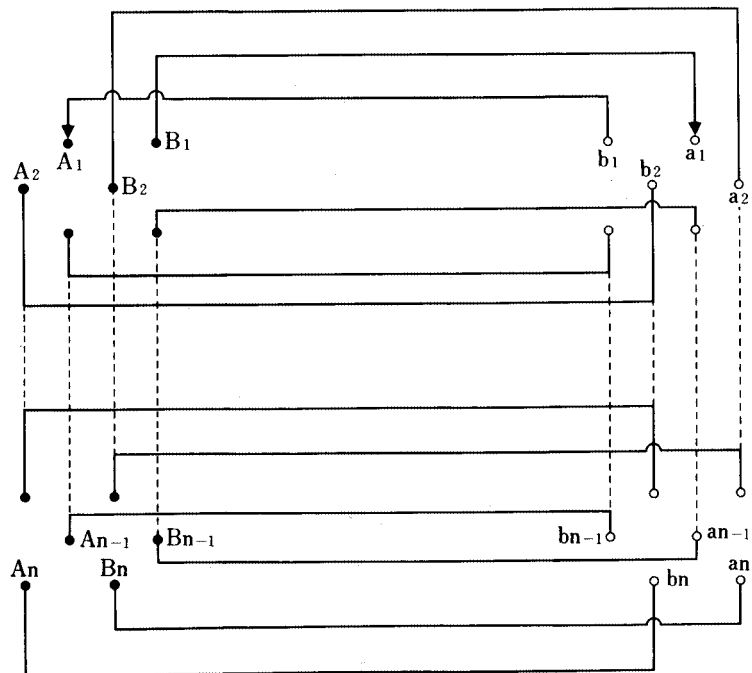
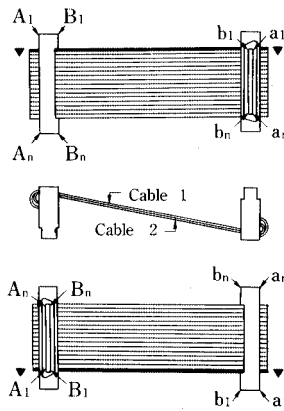

Connection to Cable 1

Connection to Cable 2

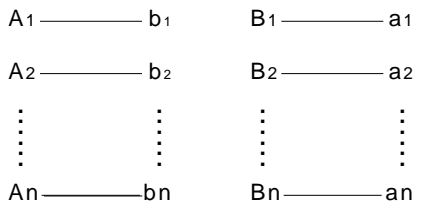

◆ Connector Use Hand book

1. Selecting connector

- ① The FX2 series is the perfect flux tight connector for the straight type in the soldering process, but it depends on the soldering process whether non-cleaning type (FX2C-*, FX2B-*) or cleaning type (FX2CA-*, FX2BA-*) should be selected. Please be sure to clean the right angle type (FX2-*, FX2B-*) connector. To clean the connector, please be sure to use detergent, containing no contaminant.
- ② To use the socket cable type, if a vibration or shock load is applied to the cable, select the lock type. In addition, if a load is applied to the cable, please be sure to use the cable clamp.

2. Prefixed Process to Board

If the prefixed process is required for mounting the board, please use the prefixed pin type. (Applicable board thickness $t = 1.6 \pm 0.1$)

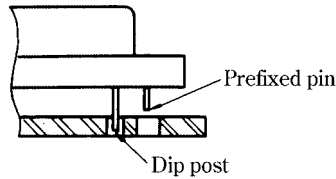

Note: In order to prevent the dip post breakage in the connector installation to the board, please insert the board in parallel to the connector so that the prefixed pin may be forcibly pushed in, after the dip post is guided to the board through-hole.

3. Mating Side Tolerance Clearance

(Example) FX2C-*P-1.27DSA and FX2C-*S-1.27DSA

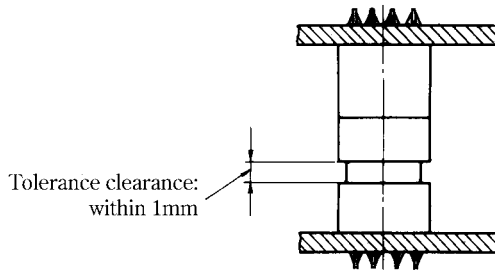

Set the tolerance clearance within 1mm to mate the male and female connectors. (Except for the lock cable type)

4. Cautions: for Using Lock Cable Type

- ① When the connector is mated, insert the connector by the end so as not to make a clearance.
- ② When the connector is inserted or extracted, please insert or extract the connector after the both lock levers are laid inside. If the connector is inserted or extracted with either lock lever laid, the connector may be broken.
- ③ please do not open the lock lever outside.

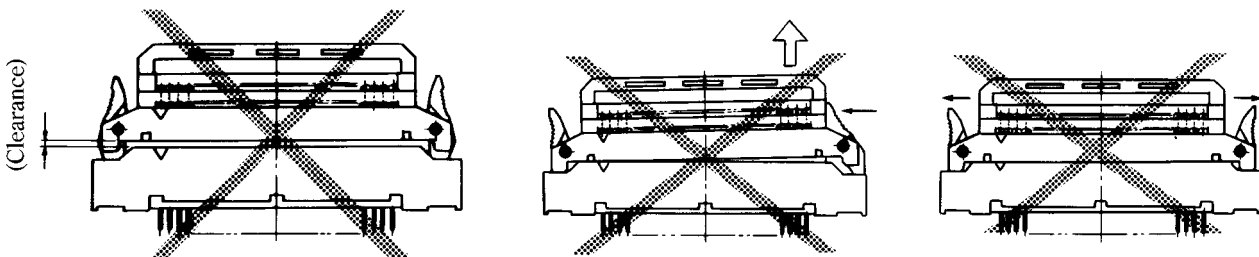

5. SMT Type Connector Mounting Temperature Profile (Reference)

● IR Reflow

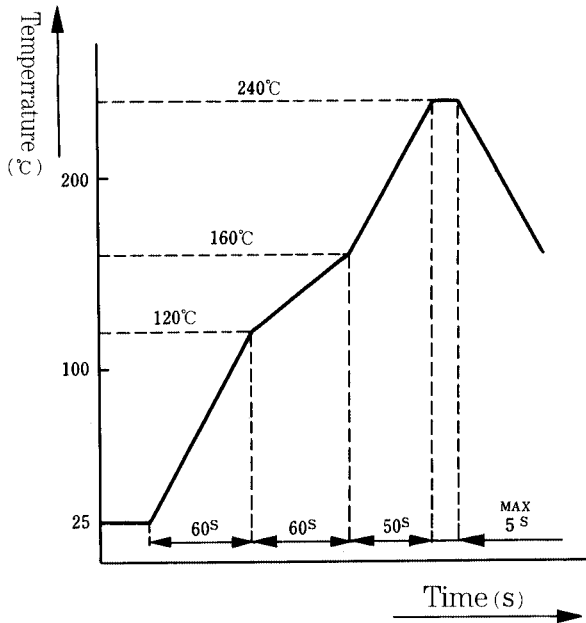

Applicable Conditions

Reflow system	: IR reflow
Solder	: Paste type 63 Sn/37 Pb (Flux content 11 wt%)
Test board	: Glass epoxy 110mm x 40mm x 1.6 mm
Metal mask thickness	: 0.2 mm (Straight type) 0.15mm (Right angle type)

Recommended temperature profile.

The temperature may be slightly changed according to the solder paste type and amount.

6. SMT Type Connector mated height

As shown in the application pattern, the mated height of the male/female connector doesn't contain the solder paste thickness. Thus, after the connector installation in the board, consider that the mated height will be widened in proportion to the solder paste thickness.