



### ■ Features

- Constant Voltage + Constant Current mode output
- Metal housing with class I design
- Standby power consumption <0.5W at remote off
- IP67 / IP65 rating for indoor or outdoor installations
- Function options: output adjustable via potentiometer; 3 in 1 dimming (dim-to-off)
- Typical lifetime > 62000 hours
- 7 years warranty

### ■ Applications

- LED high-bay lighting
- Parking space lighting
- LED fishing lamp
- LED greenhouse lighting
- Type "HL" for use in Class I , Division 2 hazardous (Classified) location.

### ■ Description

HLG-600H series is a 600W AC/DC LED driver featuring the dual mode constant voltage and constant current output. HLG-600H operates from 90 ~ 305VAC and offers models with different rated voltage ranging between 12V and 54V. Thanks to the high efficiency up to 96%, with the fanless design, the entire series is able to operate for -40°C ~ +90°C case temperature under free air convection. The design of metal housing and IP67/IP65 ingress protection level allows this series to fit both indoor and outdoor applications. HLG-600H is equipped with various function options, such as dimming methodologies, so as to provide the optimal design flexibility for LED lighting system.

### ■ Model Encoding

**HLG - 600H - 15 A**

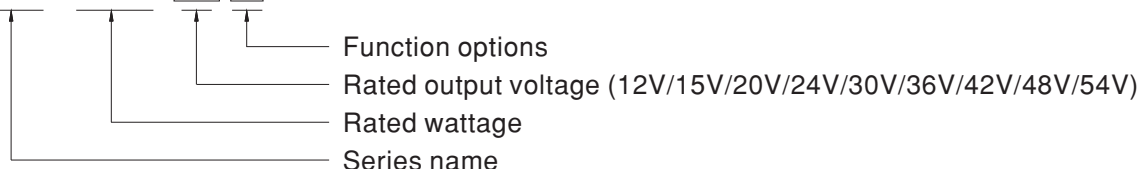

Type	IP Level	Function	Note
A	IP65	Io and Vo adjustable through built-in potentiometer	In Stock
B	IP67	3 in 1 dimming function (0~10VDC, 10V PWM signal and resistance)	In Stock
Blank	IP67	Io and Vo fixed	By request

**SPECIFICATION**

MODEL		HLG-600H-12	HLG-600H-15	HLG-600H-20	HLG-600H-24	HLG-600H-30	HLG-600H-36	HLG-600H-42	HLG-600H-48	HLG-600H-54	
OUTPUT	DC VOLTAGE	12V	15V	20V	24V	30V	36V	42V	48V	54V	
	CONSTANT CURRENT REGION <small>Note.4</small>	6 ~12V	7.5 ~ 15V	10 ~ 20V	12 ~ 24V	15 ~ 30V	18 ~ 36V	21 ~ 42V	24 ~ 48V	27 ~ 54V	
	RATED CURRENT	40A	36A	28A	25A	20A	16.7A	14.3A	12.5A	11.2A	
	RATED POWER	480W	540W	560W	600W	600W	601.2W	600.6W	600W	604.8W	
	RIPPLE & NOISE (max.) <small>Note.2</small>	150mVp-p	150mVp-p	150mVp-p	150mVp-p	200mVp-p	250mVp-p	250mVp-p	250mVp-p	350mVp-p	
	VOLTAGE ADJ. RANGE	Adjustable for A-Type only (via built-in potentiometer)									
		10.2 ~ 12.6V	12.7 ~ 15.8V	17 ~ 21V	20.4 ~ 25.2V	25.5 ~ 31.5V	30.6 ~ 37.8V	35.7 ~ 44.1V	40.8 ~ 50.4V	45.9 ~ 56.7V	
	CURRENT ADJ. RANGE	Adjustable for A-Type only (via built-in potentiometer)									
		20 ~ 40A	18 ~ 36A	14 ~ 28A	12.5 ~ 25A	10 ~ 20A	8.3 ~ 16.7A	7.1 ~ 14.3A	6.2 ~ 12.5A	5.6 ~ 11.2A	
	VOLTAGE TOLERANCE <small>Note.3</small>	±3.0%	±2.0%	±1.5%	±1.0%	±1.0%	±1.0%	±1.0%	±1.0%	±1.0%	
	LINE REGULATION	±0.5%	±0.5%	±0.5%	±0.5%	±0.5%	±0.5%	±0.5%	±0.5%	±0.5%	
LOAD REGULATION	±2.0%	±1.5%	±1.0%	±0.5%	±0.5%	±0.5%	±0.5%	±0.5%	±0.5%		
SETUP, RISE TIME <small>Note.6</small>	500ms, 80ms/ 115VAC, 230VAC										
HOLD UP TIME (Typ.)	15ms / 115VAC, 230VAC										
INPUT	VOLTAGE RANGE <small>Note.5</small>	90 ~ 305VAC    127 ~ 431VDC (Please refer to "STATIC CHARACTERISTIC" section)									
	FREQUENCY RANGE	47 ~ 63Hz									
	POWER FACTOR (Typ.)	PF ≥ 0.98/115VAC, PF ≥ 0.95/230VAC, PF ≥ 0.93/277VAC @ full load (Please refer to "POWER FACTOR (PF) CHARACTERISTIC" section)									
	TOTAL HARMONIC DISTORTION	THD < 20% (@ load ≥ 50% /115VAC, 230VAC; @ load ≥ 75%/277VAC) (Please refer to "TOTAL HARMONIC DISTORTION (THD)" section)									
	EFFICIENCY (Typ.)	230VAC	92%	93.5%	94.5%	95%	95%	95.5%	96%	96%	96%
		277VAC	92.5%	93.5%	94.5%	95%	95%	95.5%	96%	96%	96%
	AC CURRENT (Typ.)	7A / 115VAC    3.3A / 230VAC    2.9A / 277VAC									
	INRUSH CURRENT(Typ.)	COLD START 70A(twidth=1000μs measured at 50% I <sub>peak</sub> ) at 230VAC; Per NEMA 410									
	MAX. No. of PSUs on 16A CIRCUIT BREAKER	1 unit (circuit breaker of type B) / 2 units (circuit breaker of type C) at 230VAC									
	LEAKAGE CURRENT	<0.75mA / 277VAC									
STANDBY POWER CONSUMPTION	<0.5W at remote off										
PROTECTION	OVER CURRENT <small>Note.4</small>	95 ~ 108% Constant current limiting, recovers automatically after fault condition is removed									
	SHORT CIRCUIT	Constant current limiting, recovers automatically after fault condition is removed									
	OVER VOLTAGE	13 ~ 16V	16.5 ~ 20.5V	22 ~ 26V	26 ~ 30V	32.5 ~ 36.5V	39.5 ~ 43.5V	46 ~ 50V	52.5 ~ 56.5V	59 ~ 63V	
	OVER TEMPERATURE	Shut down o/p voltage, re-power on to recover									
FUNCTION	REMOTE ON/OFF CONTROL	Power on : "High" >2 ~ 5V or Open circuit    Power off : "Low" <0 ~ 0.5V or Short circuit									
	5V STANDBY	5V <sub>sb</sub> : 5V@0.5A; tolerance ±5%, ripple : 100mVp-p(max.)									
ENVIRONMENT	WORKING TEMP.	T <sub>case</sub> = -40 ~ +90°C (Please refer to "OUTPUT LOAD vs TEMPERATURE" section)									
	MAX. CASE TEMP.	T <sub>case</sub> = +90°C									
	WORKING HUMIDITY	20 ~ 95% RH non-condensing									
	STORAGE TEMP., HUMIDITY	-40 ~ +85°C, 10 ~ 95% RH									
	TEMP. COEFFICIENT	±0.03%/°C (0 ~ 55°C)									
SAFETY & EMC (Note 9)	SAFETY STANDARDS <small>Note.8</small>	UL60950-1, UL8750(type"HL"), CSA C22.2 No. 250.13-12, ENEC EN61347-1, EN61347-2-13 independent, EN62384, IP65 or IP67, J61347-1, J61347-2-13 approved									
	WITHSTAND VOLTAGE	I/P-O/P:3.75KVAC    I/P-FG:2KVAC    O/P-FG:1.5KVAC									
	ISOLATION RESISTANCE	I/P-O/P, I/P-FG, O/P-FG:100M Ohms / 500VDC / 25°C / 70% RH									
	EMC EMISSION <small>Note.8</small>	Compliance to EN55015, EN55022(CISPR22) Class B, EN61000-3-2 Class C (@ load ≥ 50%); EN61000-3-3									
	EMC IMMUNITY	Compliance to EN61000-4-2,3,4,5,6,8,11, EN61547, EN55024, light industry level (surge immunity Line-Earth 4KV, Line-Line 2KV)									
OTHERS	MTBF	76.9K hrs min.    MIL-HDBK-217F (25°C)									
	DIMENSION	280*144*48.5mm (L*W*H)									
	PACKING	3.9Kg; 4pcs/16.6Kg/0.9CUFT									
NOTE	1. All parameters NOT specially mentioned are measured at 230VAC input, rated current and 25°C of ambient temperature. 2. Ripple & noise are measured at 20MHz of bandwidth by using a 12" twisted pair-wire terminated with a 0.1uf & 47uf parallel capacitor. 3. Tolerance : includes set up tolerance, line regulation and load regulation. 4. Please refer to "DRIVING METHODS OF LED MODULE". 5. De-rating may be needed under low input voltages. Please refer to "STATIC CHARACTERISTIC" sections for details. 6. Length of set up time is measured at first cold start. Turning ON/OFF the driver may lead to increase of the set up time. 7. The driver is considered a component which will be installed into a final equipment. All the EMC tests are been executed by mounting the unit on a 360mm*360mm metal plate with 1mm of thickness. The final equipment must be re-confirmed that it still meets EMC directives. For guidance on how to perform these EMC tests, please refer to "EMI testing of component power supplies." (as available on <a href="http://www.meanwell.com">http://www.meanwell.com</a> ) 8. The model certified for CCC(GB19510.14, GB19510.1, GB17743 and GB17625.1) is an optional model . Please contact MEAN WELL for details. 9. This series meets the typical life expectancy of >62,000 hours of operation when T <sub>case</sub> , particularly (T <sub>c</sub> ) point (or TMP, per DLC), is about 75°C or less. 10. Please refer to the warranty statement on MEAN WELL's website at <a href="http://www.meanwell.com">http://www.meanwell.com</a>										

## ■ BLOCK DIAGRAM

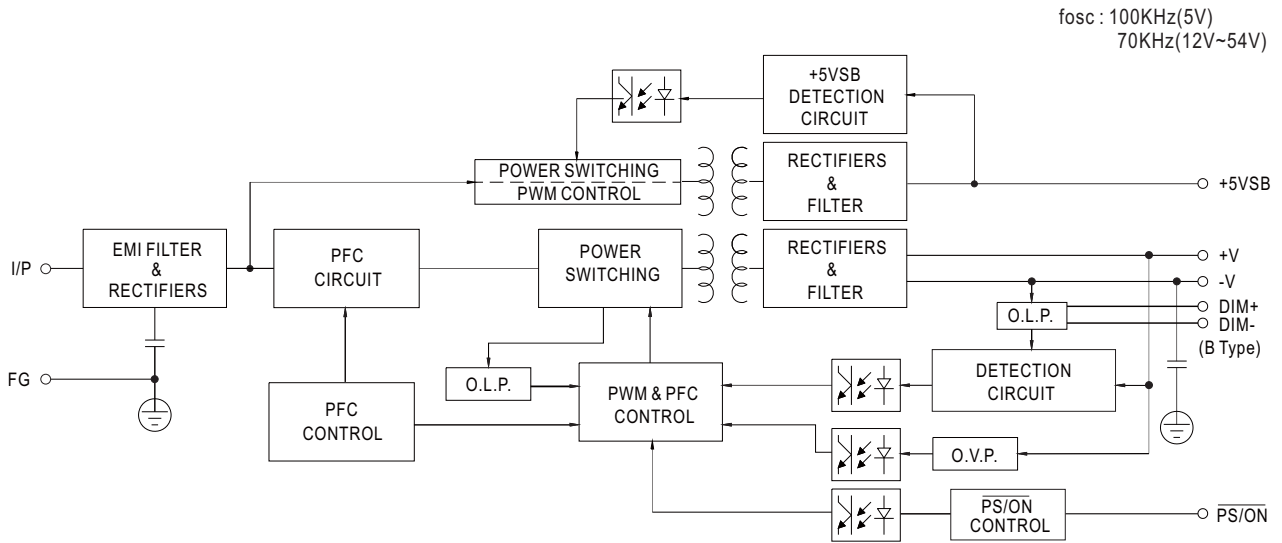

## ■ DRIVING METHODS OF LED MODULE

※ This series is able to work in either Constant Current mode (a direct drive way) or Constant Voltage mode (usually through additional DC/DC driver) to drive the LEDs.

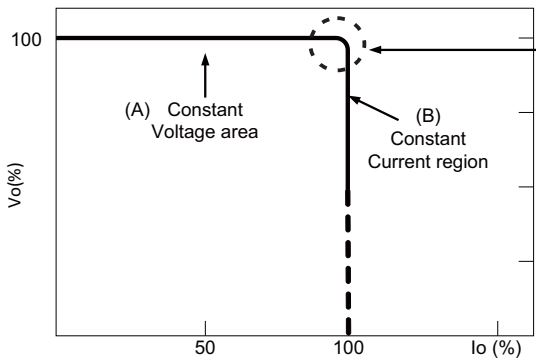

Typical output current normalized by rated current (%)

In the constant current region, the highest voltage at the output of the driver depends on the configuration of the end systems.

Should there be any compatibility issues, please contact MEAN WELL.

## DIMMING OPERATION

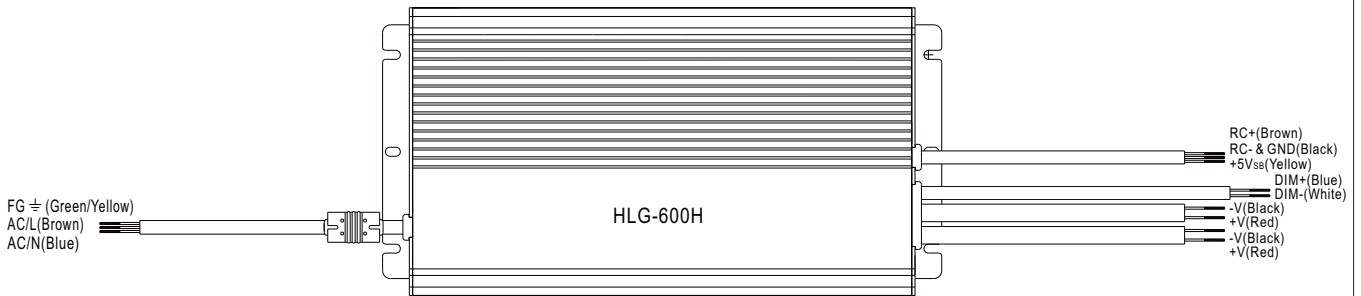

### ※ 3 in 1 dimming function (for B-Type)

- Output constant current level can be adjusted by applying one of the three methodologies between DIM+ and DIM-: 0 ~ 10VDC, or 10V PWM signal or resistance.
- Direct connecting to LEDs is suggested. It is not suitable to be used with additional drivers.
- Dimming source current from power supply: 100 $\mu$ A (typ.)

#### ◎ Applying additive 0 ~ 10VDC

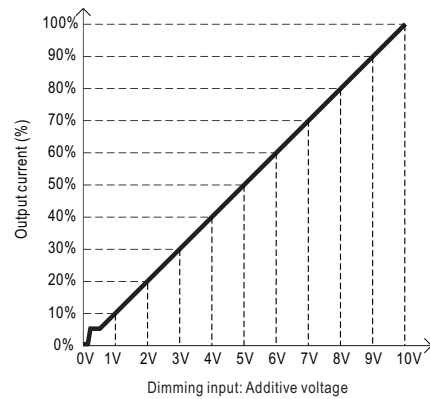
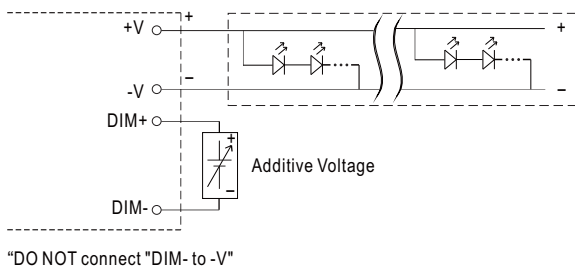

#### ◎ Applying additive 10V PWM signal (frequency range 100Hz ~ 3KHz):

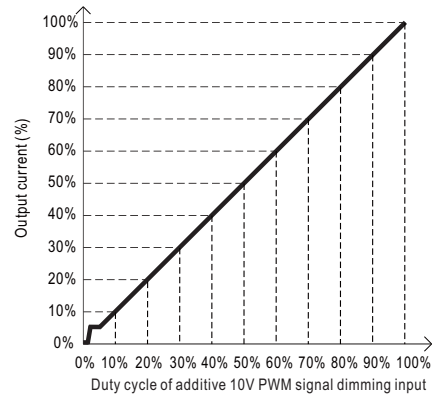
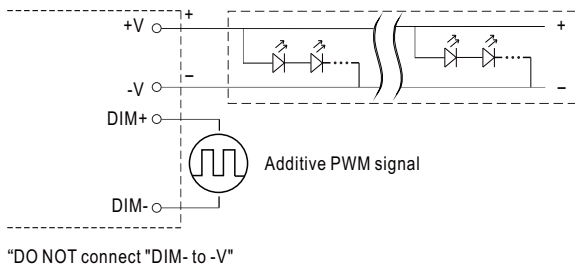

#### ◎ Applying additive resistance:

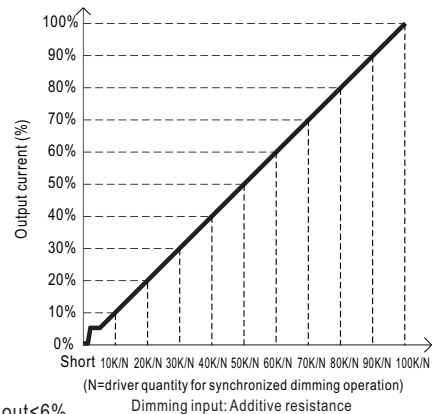
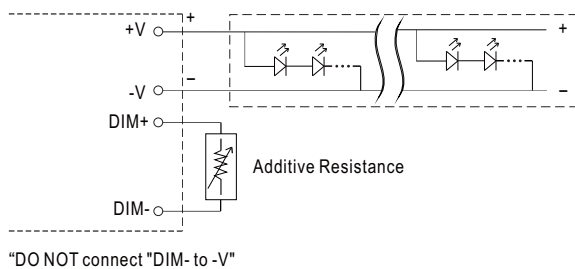

- Note : 1. Min. dimming level is about 6% and the output current is not defined when  $0\% < I_{out} < 6\%$ .  
 2. The output current could drop down to 0% when dimming input is about 0k $\Omega$  or 0Vdc, or 10V PWM signal with 0% duty cycle.

### OUTPUT LOAD vs TEMPERATURE

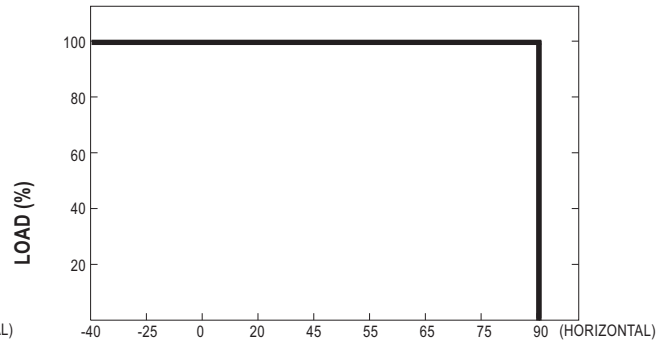
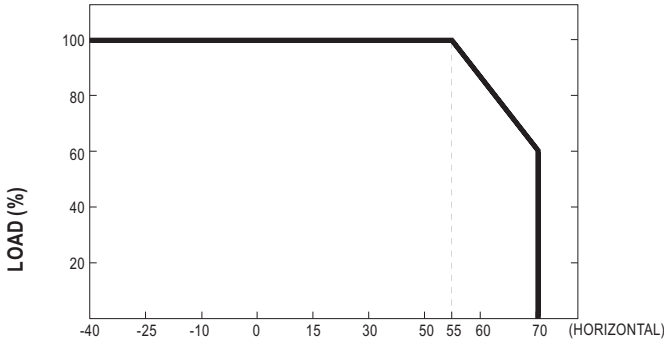

AMBIENT TEMPERATURE, Ta (°C)

Tcase (°C)

⊙ At high ambient temperature Ta=70°C, if HLG-600H operates in C.C mode, the maximal current must not be greater than 60% of the rated current.

### STATIC CHARACTERISTICS

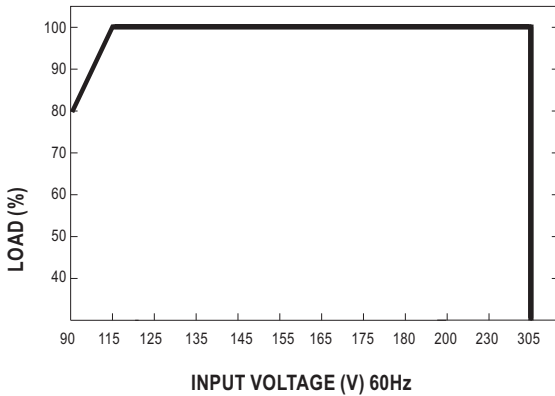

※ De-rating is needed under low input voltage.

### POWER FACTOR(PF) CHARACTERISTIC

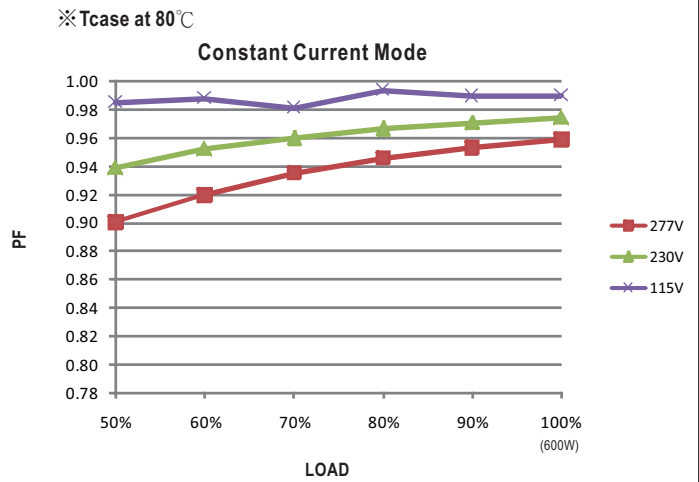

### TOTAL HARMONIC DISTORTION (THD)

※ 48V Model, Tcase at 80°C

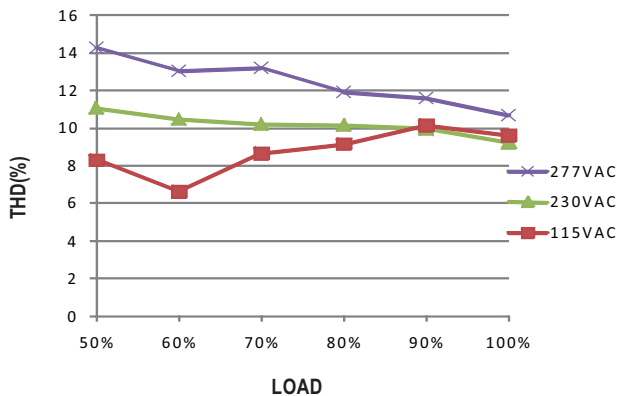

### EFFICIENCY vs LOAD

HLG-600H series possess superior working efficiency that up to 96% can be reached in field applications.

※ 48V Model, Tcase at 80°C

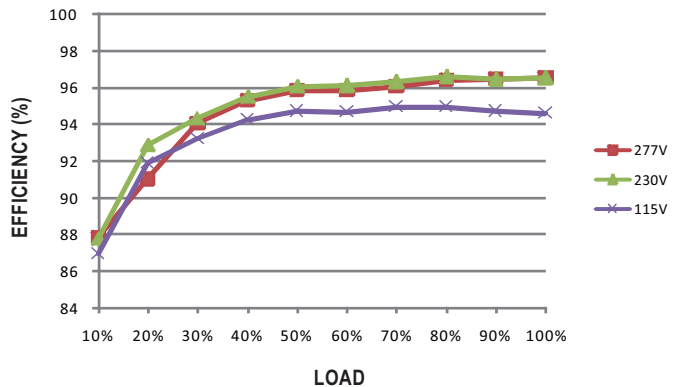



■ LIFETIME

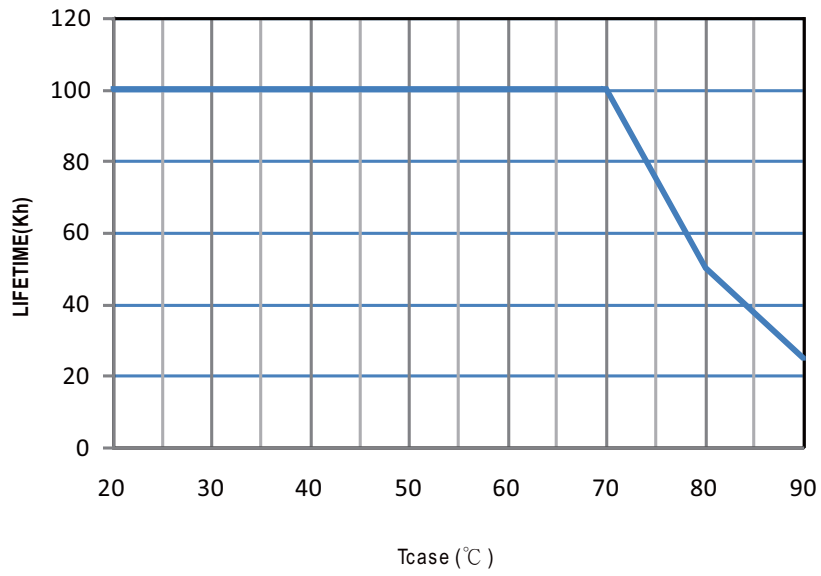

**MECHANICAL SPECIFICATION**

Case No. 228 Unit:mm

※A-Type

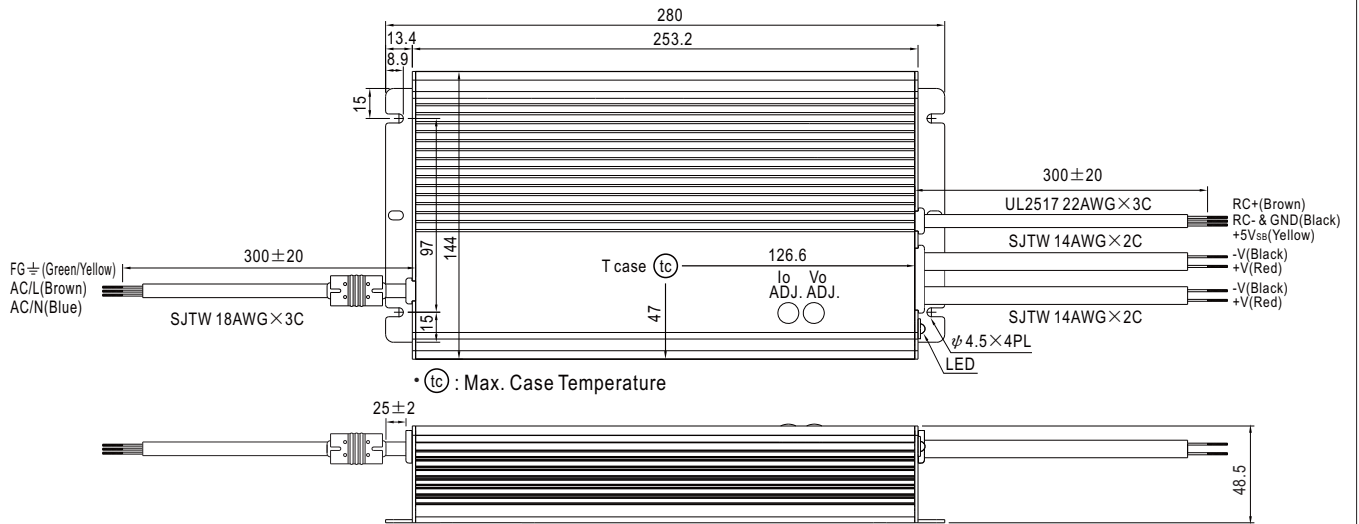

※B-Type

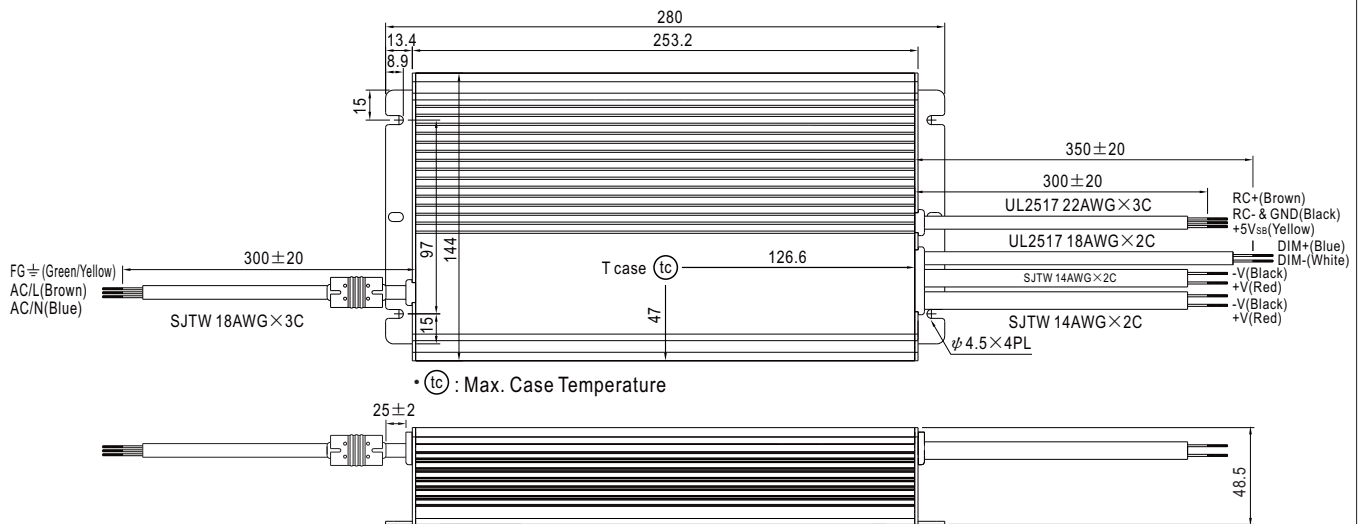

※Blank-Type

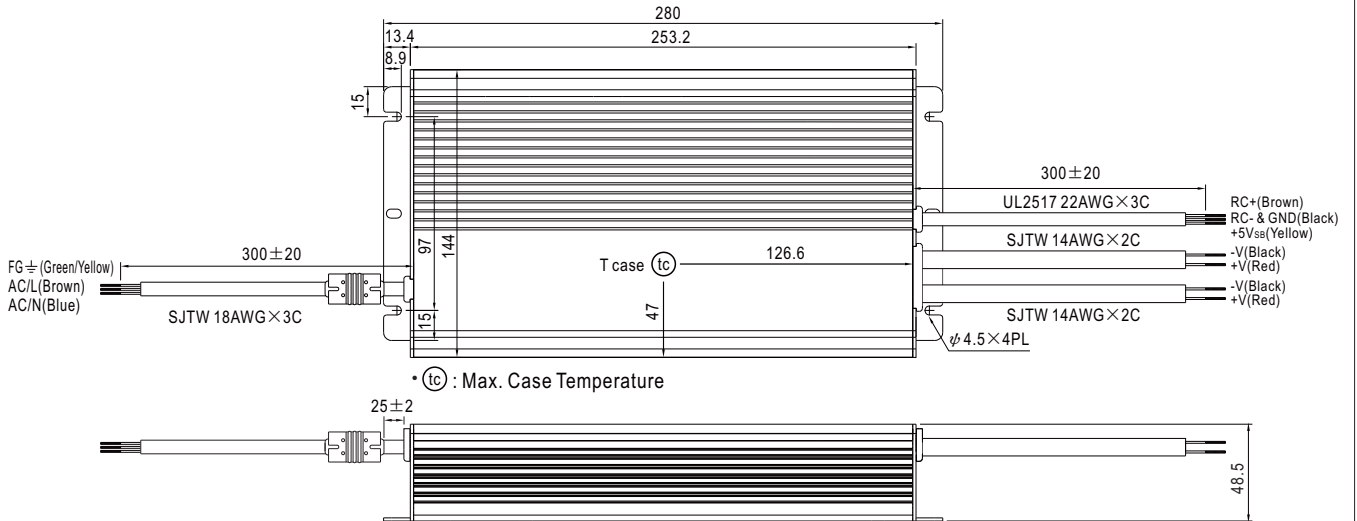

■ INSTALLATION MANUAL

Please refer to : <http://www.meanwell.com/manual.html>