

FS2A-L THRU FS2M-L

2.0 Amp Fast Recovery Rectifier 50 to 1000 Volts

Features

- Lead Free Finish/Rohs Compliant (Note1) ("P" Suffix designates Compliant. See ordering information)
- Epoxy meets UL 94 V-0 flammability rating
- Moisture Sensitivity Level 1
- Higher Temp Soldering: 260°C for 10 Seconds At Terminals
- Available on Tape and Reel
- Halogen free available upon request by adding suffix "-HF"

Maximum Ratings

- Operating Temperature: -50°C to +150°C
- Storage Temperature: -50°C to +150°C

MCC Catalog Number	Device Marking	Maximum Recurrent Peak Reverse Voltage	Maximum RMS Voltage	Maximum DC Blocking Voltage
FS2A-L	FS2A	50V	35V	50V
FS2B-L	FS2B	100V	70V	100V
FS2D-L	FS2D	200V	140V	200V
FS2G-L	FS2G	400V	280V	400V
FS2J-L	FS2J	600V	420V	600V
FS2K-L	FS2K	800V	560V	800V
FS2M-L	FS2M	1000V	700V	1000V

Electrical Characteristics @ 25°C Unless Otherwise Specified

Average Forward Current	$I_{F(AV)}$	2.0A	$T_J=90^\circ\text{C}$
Peak Forward Surge Current	I_{FSM}	50A	8.3ms half sine
Maximum Instantaneous Forward Voltage	V_F	1.30V	$I_{FM}=2.0A$ $T_A=25^\circ\text{C}^*$
Maximum DC Reverse Current At Rated DC Blocking Voltage	I_R	5.0uA	$T_J=25^\circ\text{C}$
Maximum Reverse Recovery Times FS2A-L~FS2G-L FS2J-L FS2K-L~FS2M-L	t_{rr}	150ns 250ns 500ns	$I_F=0.5A$, $I_R=1.0A$, $I_{rr}=0.25A$
Typical Junction Capacitance	C_j	50pF	Measured at 1.0MHz, $V_R=4.0V$

Note:1. High Temperature Solder Exemptions Applied, see EU Directive Annex 7.
 *Pulse test: Pulse width 300 usec, duty cycle 2%.

DO-214AC (SMA) (LEAD FRAME)

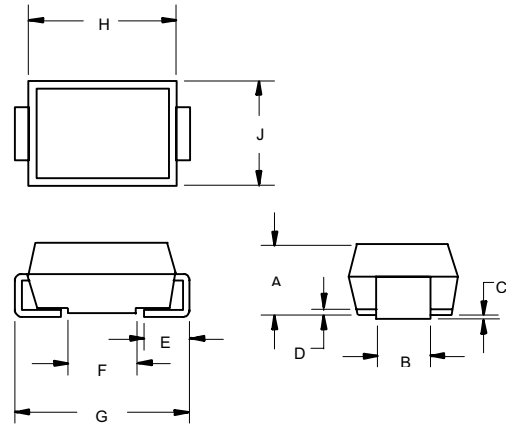

DIM	DIMENSIONS				NOTE
	INCHES		MM		
A	.079	.096	2.00	2.44	
B	.050	.064	1.27	1.63	
C	.002	.008	.05	.20	
D	---	.02	---	.51	
E	.030	.060	.76	1.52	
F	.065	.091	1.65	2.32	
G	.189	.220	4.80	5.59	
H	.157	.181	4.00	4.60	
J	.090	.115	2.25	2.92	

SUGGESTED SOLDER PAD LAYOUT

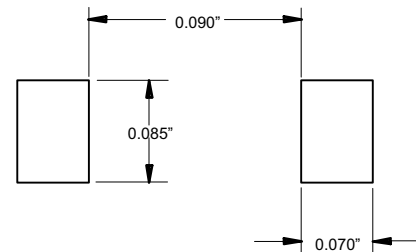

FS2A-L thru FS2M-L

Figure 1
Typical Forward Characteristics

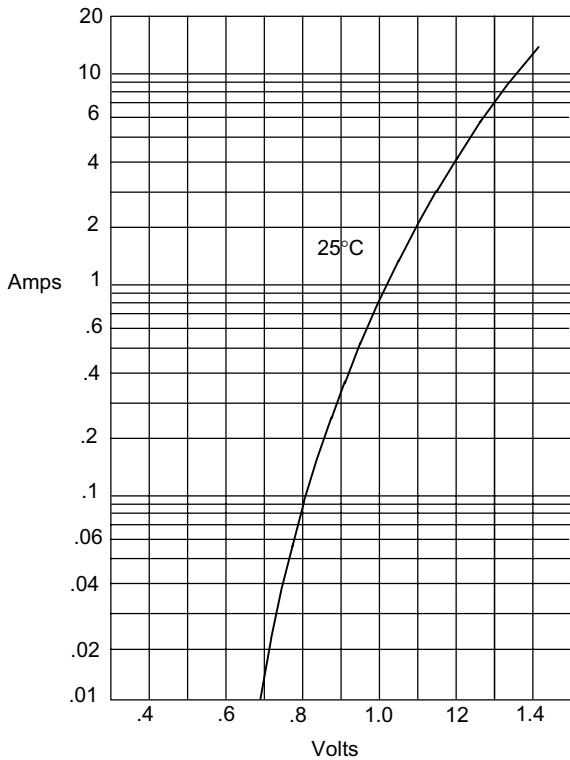

Instantaneous Forward Current - Amperes *versus*
Instantaneous Forward Voltage - Volts

Figure 2
Forward Derating Curve

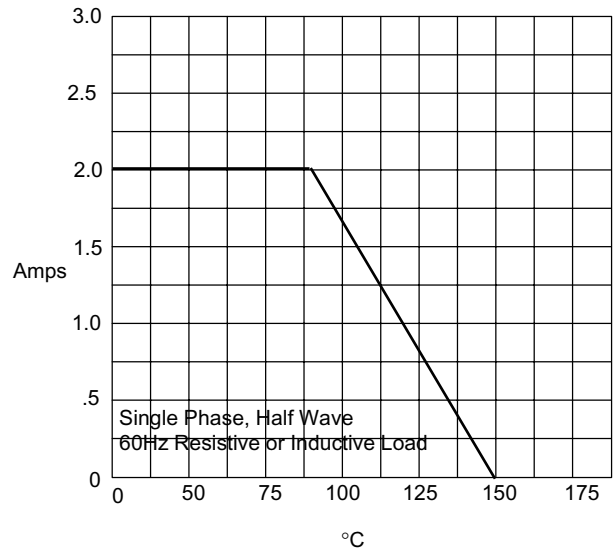

Average Forward Rectified Current - Amperes *versus*
Ambient Temperature - °C

Figure 3
Junction Capacitance

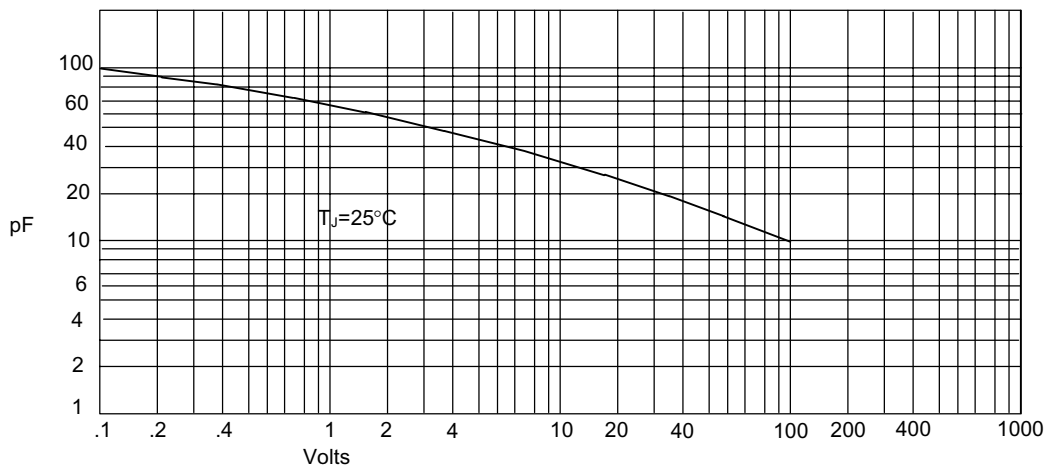

Junction Capacitance - pF *versus*
Reverse Voltage - Volts

FS2A-L thru FS2M-L

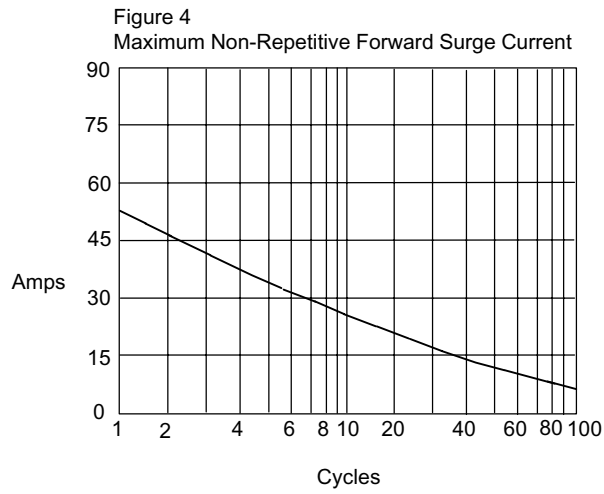

Peak Forward Surge Current - Amperes versus
Number Of Cycles At 60Hz - Cycles

Figure 5
Reverse Recovery Time Characteristic And Test Circuit Diagram

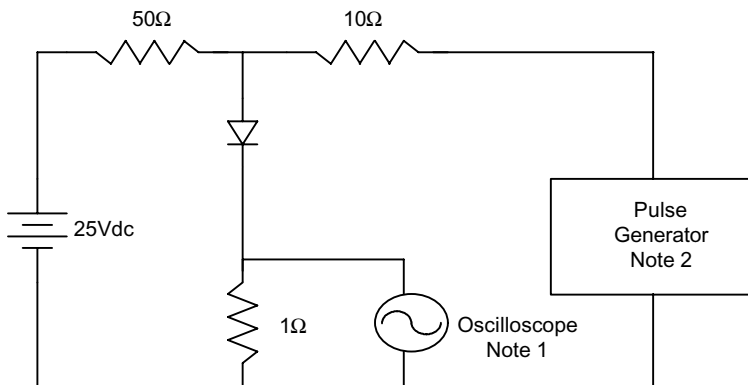

- Notes:
1. Rise Time = 7ns max.
Input impedance = 1 megohm, 22pF
 2. Rise Time = 10ns max.
Source impedance = 50 ohms
 3. Resistors are non-inductive

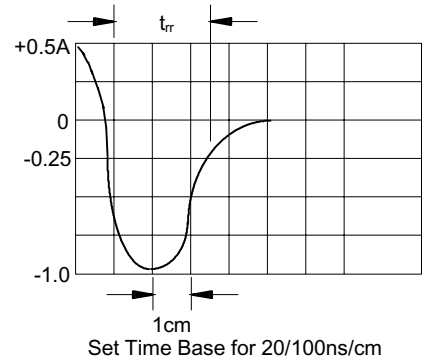



TM

Micro Commercial Components

Ordering Information :

Device	Packing
FS2A-LTP~FS2M-LTP	Tape&Reel: 5Kpcs/Reel

Note : Adding "-HF" suffix for halogen free, eg. FS2A-LTP-HF~FS2M-LTP-HF

IMPORTANT NOTICE

Micro Commercial Components Corp. reserves the right to make changes without further notice to any product herein to make corrections, modifications , enhancements , improvements , or other changes . **Micro Commercial Components Corp .** does not assume any liability arising out of the application or use of any product described herein; neither does it convey any license under its patent rights ,nor the rights of others . The user of products in such applications shall assume all risks of such use and will agree to hold **Micro Commercial Components Corp .** and all the companies whose products are represented on our website, harmless against all damages.

LIFE SUPPORT

MCC's products are not authorized for use as critical components in life support devices or systems without the express written approval of Micro Commercial Components Corporation.

CUSTOMER AWARENESS

Counterfeiting of semiconductor parts is a growing problem in the industry. Micro Commercial Components (MCC) is taking strong measures to protect ourselves and our customers from the proliferation of counterfeit parts. MCC strongly encourages customers to purchase MCC parts either directly from MCC or from Authorized MCC Distributors who are listed by country on our web page cited below. Products customers buy either from MCC directly or from Authorized MCC Distributors are genuine parts, have full traceability, meet MCC's quality standards for handling and storage. **MCC will not provide any warranty coverage or other assistance for parts bought from Unauthorized Sources.** MCC is committed to combat this global problem and encourage our customers to do their part in stopping this practice by buying direct or from authorized distributors.

www.mccsemi.com