

Features

- Single Stage, Single Ended
- 8 V, 130 mA or 5 V, 110 mA Operation
- 18 dB Flat Gain
- Low Noise
- Low Distortion Performance
- Lead-Free SOT-89 Plastic Package
- Halogen-Free “Green” Mold Compound
- RoHS* Compliant

Description

The MAAM-011220 is an RF amplifier assembled in a SOT-89 plastic package. This amplifier provides 18 dB of ultra flat gain while biased at either 8 or 5 volts. The amplifier provides excellent linearity.

The MAAM-011220 provides high gain, low noise and low distortion making it ideally suited for 75 Ω infrastructure applications.

The MAAM-011220 is fabricated using GaAs pHEMT technology.

Functional Schematic

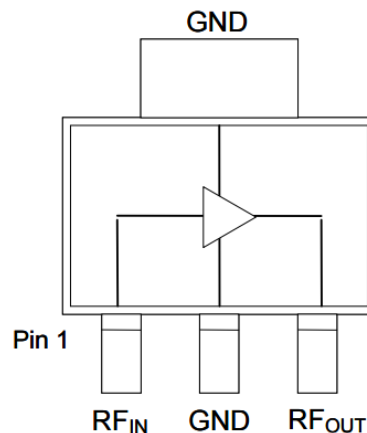

Pin Configuration

Pin No.	Pin Name	Function
1	RF _{IN}	RF Input
2	GND	Ground
3	RF _{OUT}	RF Output / Drain Supply

Ordering Information^{1,2}

Part Number	Package
MAAM-011220-TR1000	1000 piece reel
MAAM-011220-TR3000	3000 piece reel
MAAM-011220-001SMB	Sample Board

1. Reference Application Note M513 for reel size information.
2. All sample boards include 5 loose parts.

* Restrictions on Hazardous Substances, European Union Directive 2011/65/EU.

75 Ω , High Linearity, Low Noise, CATV Amplifier 45 - 1218 MHz

Rev. V1

Electrical Specifications: Freq. = 45 - 1218 MHz, $T_A = 25^\circ\text{C}$, $V_{DD} = 8\text{ V}$, $Z_0 = 75\ \Omega$

Parameter	Test Conditions	Units	Min.	Typ.	Max.
Gain	1218 MHz	dB	18	18.5	20
Tilt	45 - 1218 MHz	dB	—	0.5	—
Reverse Isolation	—	dB	—	21.5	—
Input Return Loss	—	dB	—	20	—
Output Return Loss	—	dB	—	24	—
Noise Figure	50 - 100 MHz 100 - 1218 MHz	dB	—	2.6 2.4	4 3.1
Output IP2	45 - 1218 MHz, tone spacing 6 MHz, P_{OUT} per tone = -10 dBm	dBm	—	66	—
Output IP3	45 - 1218 MHz, tone spacing 6 MHz, P_{OUT} per tone = -10 dBm	dBm	—	38	—
P1dB	—	dBm	—	24	—
Composite Triple Beat, CTB	79 channels, 0 dB Tilt, 34 dBmV per channel output, QAM to 1000 MHz	dBc	—	-73	—
	132 channels, 15 dBmV per channel input			-71	
Composite Second Order, CSO	79 channels, 0 dB Tilt, 34 dBmV per channel output, QAM to 1000 MHz	dBc	—	-69	—
	132 channels, 15 dBmV per channel input			-65	
I_{DD}	$V_{DD} = 8\text{ V}$	mA	110	130	145

Absolute Maximum Ratings^{3,4,5,6}

Parameter	Absolute Maximum
Max Input Power	12 dBm
Operating Voltage	10 volts
Operating Temperature	-40°C to +85°C
Storage Temperature	-65°C to +150°C

- Exceeding any one or combination of these limits may cause permanent damage to this device.
- MACOM does not recommend sustained operation near these survivability limits.
- These operating conditions will ensure MTTF > 1 x 10⁶ hours.
- Junction Temperature (T_J) = Case Temperature (T_C) + $\Theta_{JC} \cdot (V \cdot I)$
Typical thermal resistance (Θ_{JC}) = 50.4°C/W.
 - For $T_C = 25^\circ\text{C}$,
 $T_J = 67.5^\circ\text{C} @ 8\text{ V}, 130\text{ mA}$
 - For $T_C = 85^\circ\text{C}$,
 $T_J = 137.5^\circ\text{C} @ 8\text{ V}, 130\text{ mA}$

Handling Procedures

Please observe the following precautions to avoid damage:

Static Sensitivity

Gallium Arsenide Integrated Circuits are sensitive to electrostatic discharge (ESD) and can be damaged by static electricity. Proper ESD control techniques should be used when handling these HBM Class1A devices.

Recommended PCB Layout

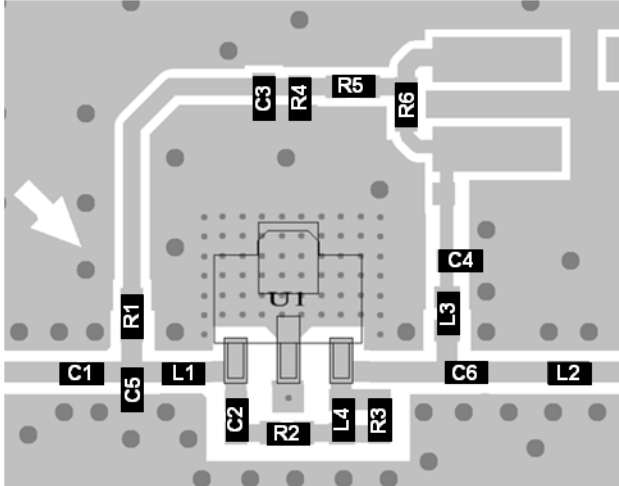

Parts List⁷

Component	Value	Package
C1-C4	10 nF	0402
C5	0.9 pF	0402
C6	150 pF	0402
L1	10 nH	0402
L2	4.3 nH	0402
L3	Ferrite Bead	0402
L4	18 nH	0402
R1	8 k Ω	0402
R2	750 Ω	0402
R3	165 Ω	0402
R4	549 Ω	0402
R5	5 k Ω	0402
R6	0 Ω	0402

Schematic Including Off-Chip Components

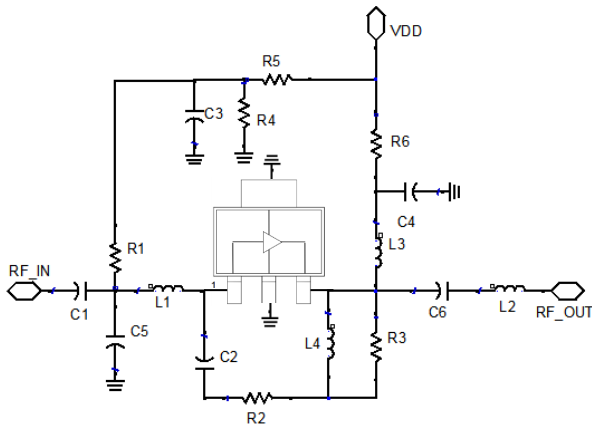

7. Ferrite Bead from Murata, part number BLM15HD182SN.

PCB Land Pattern

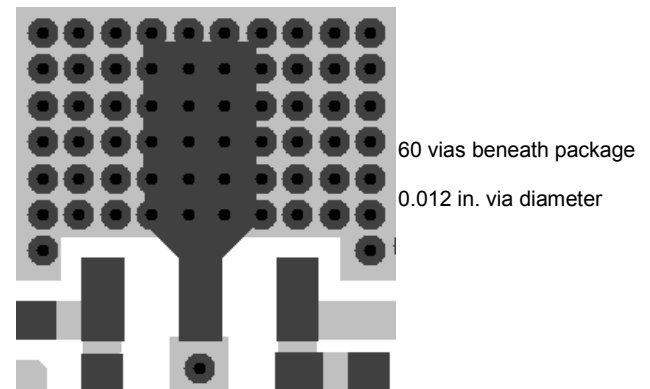

75 Ω , High Linearity, Low Noise, CATV Amplifier 45 - 1218 MHz

Rev. V1

Typical Performance Curves: $V_{DD} = 8\text{ V}$

Gain to 1.218 GHz

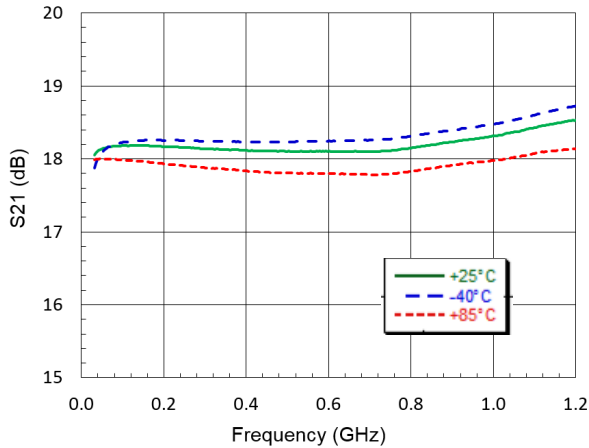

Gain to 3 GHz

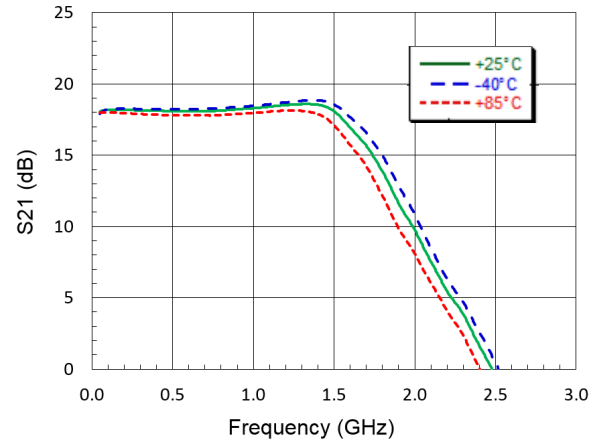

Input Return Loss

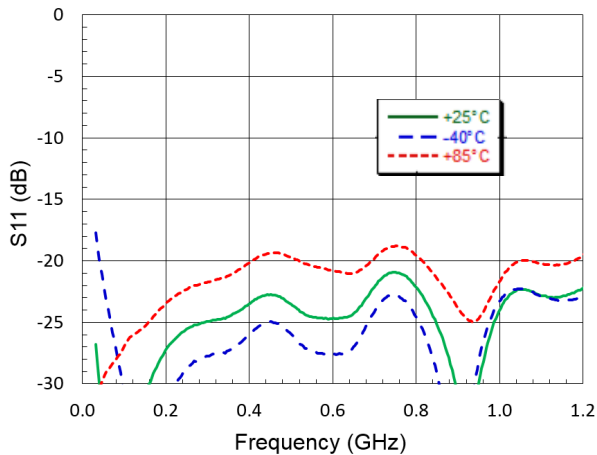

Output Return Loss

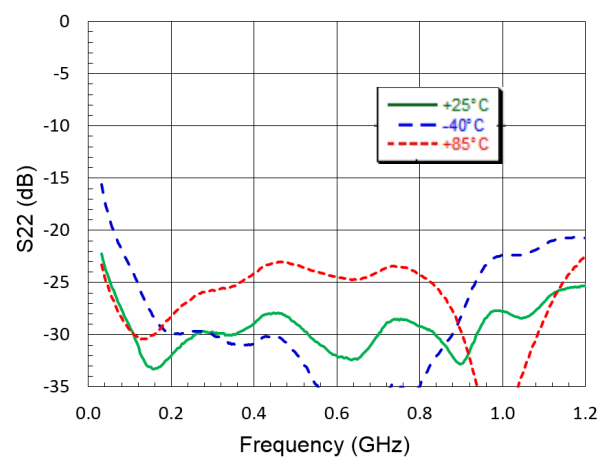

Reverse Isolation

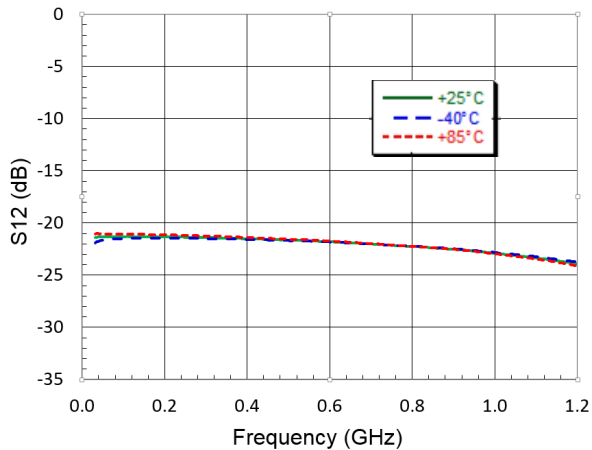

Noise Figure

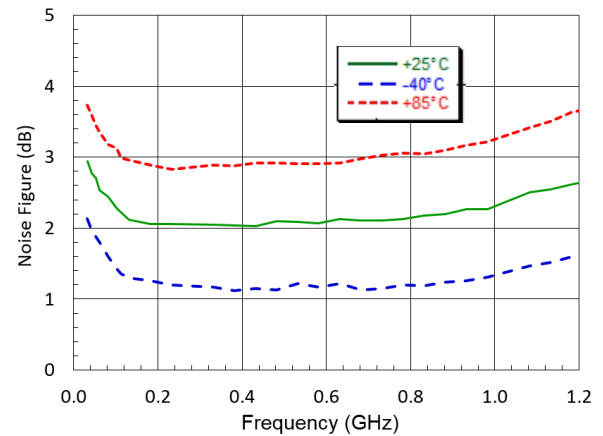

75 Ω , High Linearity, Low Noise, CATV Amplifier 45 - 1218 MHz

Rev. V1

Typical Performance Curves: $V_{DD} = 8\text{ V}$

CSO Lower

79 analog ch + QAM, 0 dB tilt, $P_{OUT} = 34\text{ dBmV per ch}$

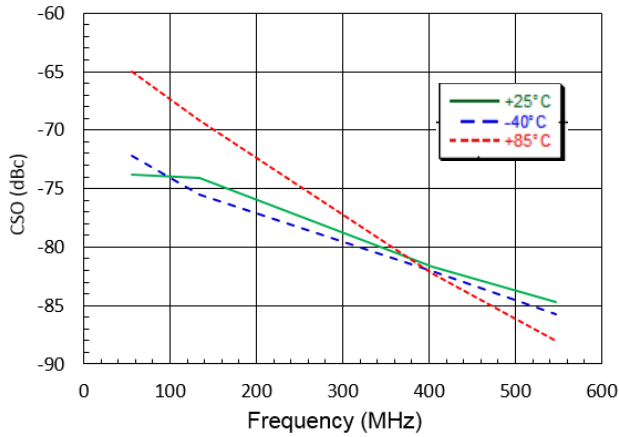

CSO Upper

79 analog ch + QAM, 0 dB tilt, $P_{OUT} = 34\text{ dBmV per ch}$

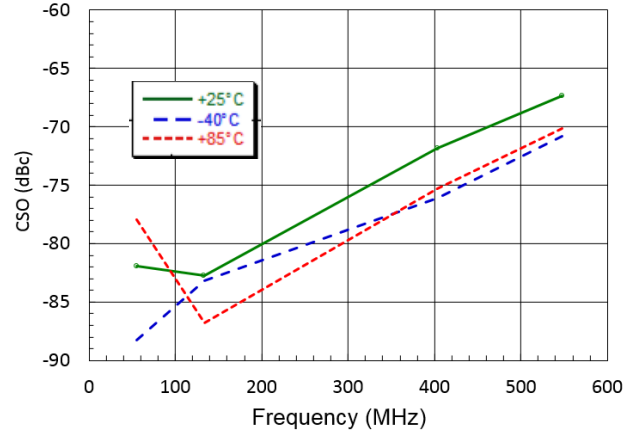

CTB

79 analog ch + QAM, 0 dB tilt, $P_{OUT} = 34\text{ dBmV per ch}$

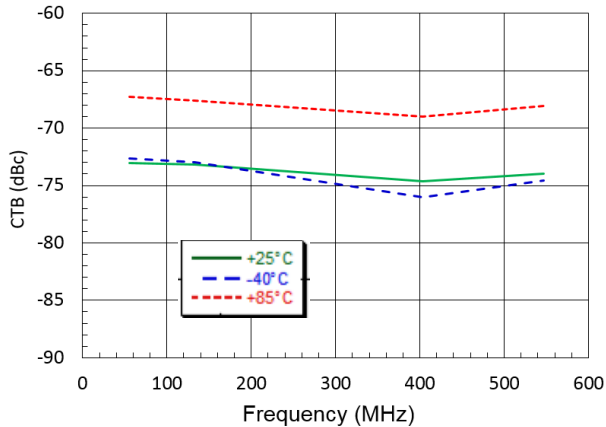

CTB

132 analog ch, $P_{IN} = 15\text{ dBmV per ch, } +25^\circ\text{C}$

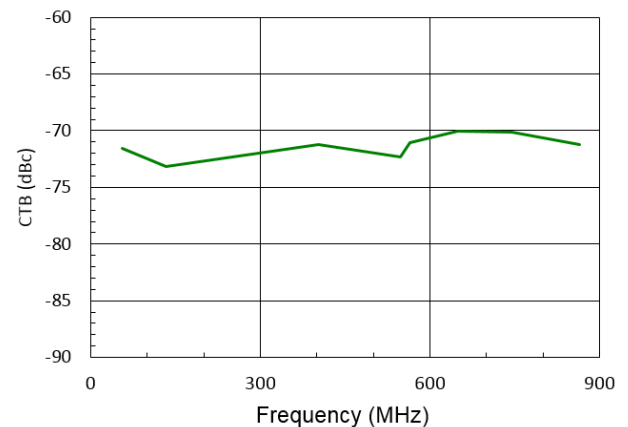

CSO Lower

132 analog ch, $P_{IN} = 15\text{ dBmV per ch, } +25^\circ\text{C}$

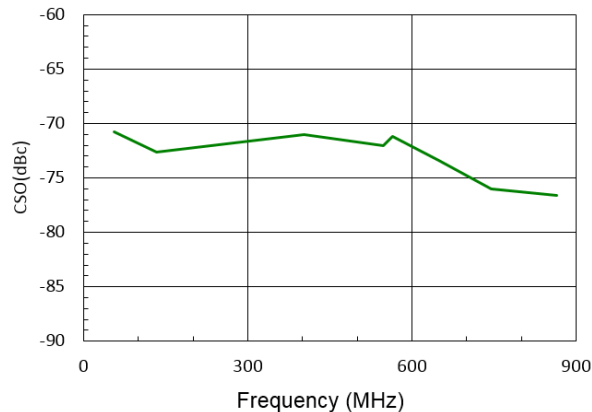

CSO Upper

132 analog ch, $P_{IN} = 15\text{ dBmV per ch, } +25^\circ\text{C}$

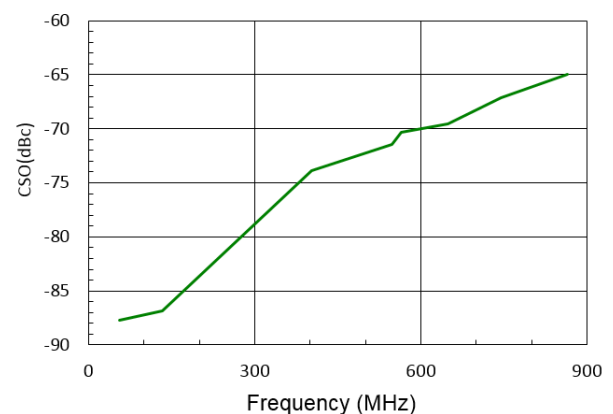

75 Ω , High Linearity, Low Noise, CATV Amplifier 45 - 1218 MHz

Rev. V1

Electrical Specifications⁸: Freq. = 45 - 1218 MHz, T_A = 25°C, V_{DD} = 5 V, Z₀ = 75 Ω

Parameter	Test Conditions	Units	Min.	Typ.	Max.
Gain	1218 MHz	dB	—	18.5	—
Tilt	45 - 1218 MHz	dB	—	0.5	—
Reverse Isolation	—	dB	—	21.5	—
Input Return Loss	—	dB	—	20	—
Output Return Loss	—	dB	—	24	—
Noise Figure	50 - 100 MHz 100 - 1218 MHz	dB	—	2.6 2.4	—
Output IP2	45 - 1218 MHz, tone spacing 6 MHz, P _{OUT} per tone = -10 dBm	dBm	—	64	—
Output IP3	45 - 1218 MHz, tone spacing 6 MHz, P _{OUT} per tone = -10 dBm	dBm	—	37	—
P1dB	—	dBm	—	20	—
Composite Triple Beat, CTB	79 channels, 0 dB Tilt, 34 dBmV per channel output, QAM to 1000 MHz 132 channels, 15 dBmV per channel input	dBc	—	-73 -70	—
Composite Second Order, CSO	79 channels, 0 dB Tilt, 34 dBmV per channel output, QAM to 1000 MHz 132 channels, 15 dBmV per channel input	dBc	—	-67 -65	—
I _{DD}	V _{DD} = 5 V	mA	—	110	—

8. The same application circuit and component values are used for VDD=5V and VDD=8V operation.

75 Ω , High Linearity, Low Noise, CATV Amplifier 45 - 1218 MHz

Rev. V1

Typical Performance Curves: $V_{DD} = 5\text{ V}$

Gain to 1.218 GHz

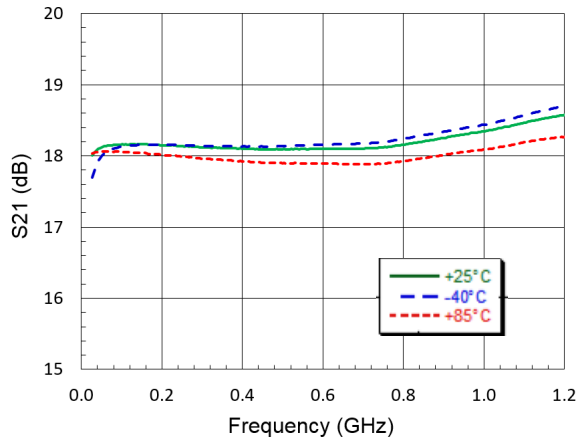

Gain to 3 GHz

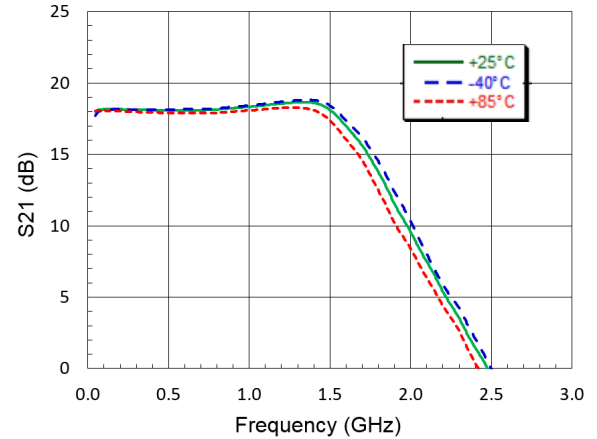

Input Return Loss

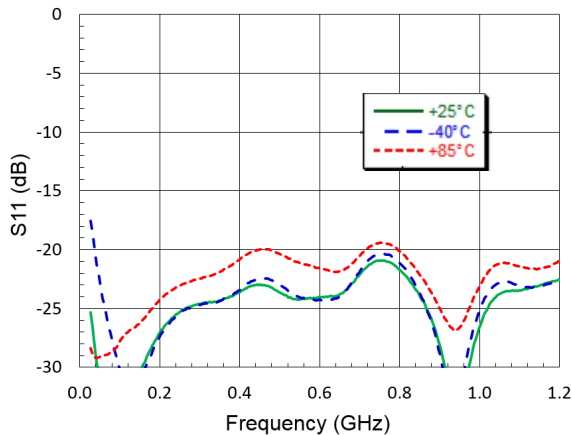

Output Return Loss

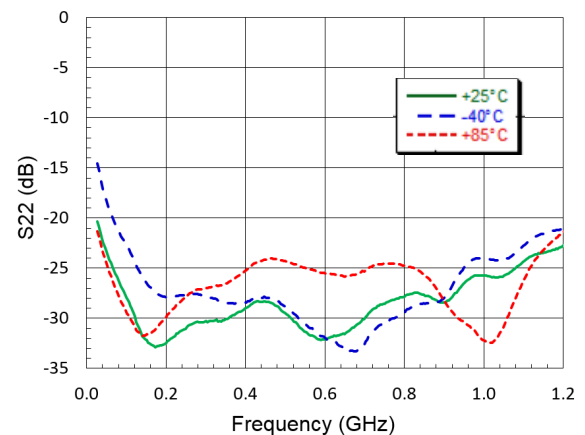

Reverse Isolation

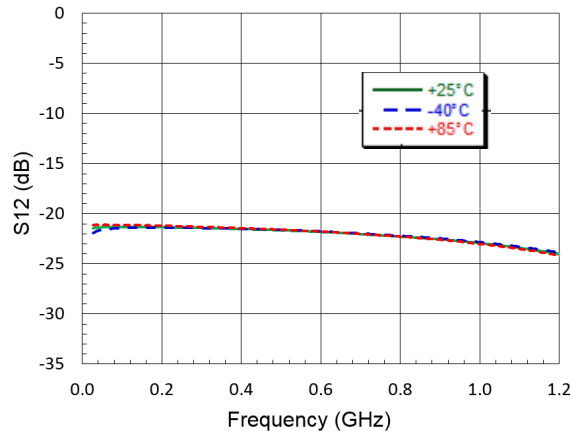

Noise Figure

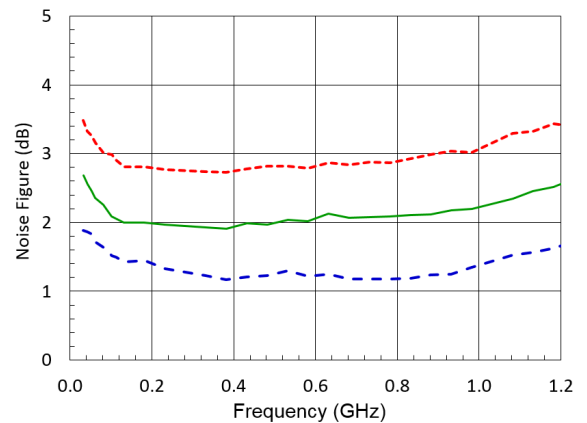

75 Ω , High Linearity, Low Noise, CATV Amplifier 45 - 1218 MHz

Rev. V1

Typical Performance Curves: $V_{DD} = 5\text{ V}$

CSO Lower

79 analog ch + QAM, 0 dB tilt, $P_{OUT} = 34\text{ dBmV per ch}$

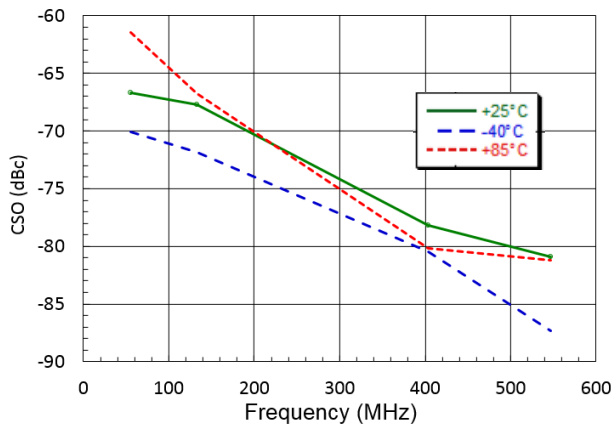

CSO Upper

79 analog ch + QAM, 0 dB tilt, $P_{OUT} = 34\text{ dBmV per ch}$

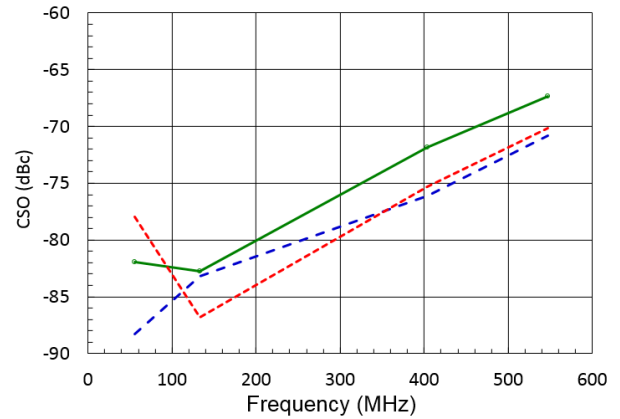

CTB

79 analog ch + QAM, 0 dB tilt, $P_{OUT} = 34\text{ dBmV per ch}$

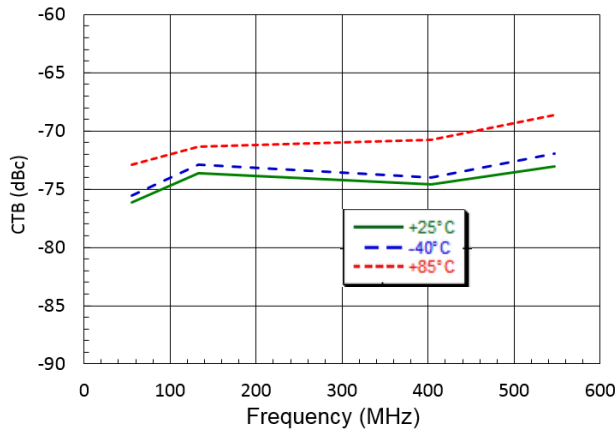

CTB

132 analog ch, $P_{IN} = 15\text{ dBmV per ch, } +25^\circ\text{C}$

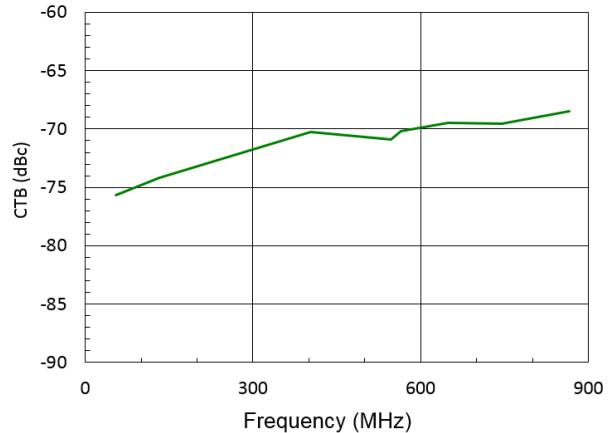

CSO Lower

132 analog ch, $P_{IN} = 15\text{ dBmV per ch, } +25^\circ\text{C}$

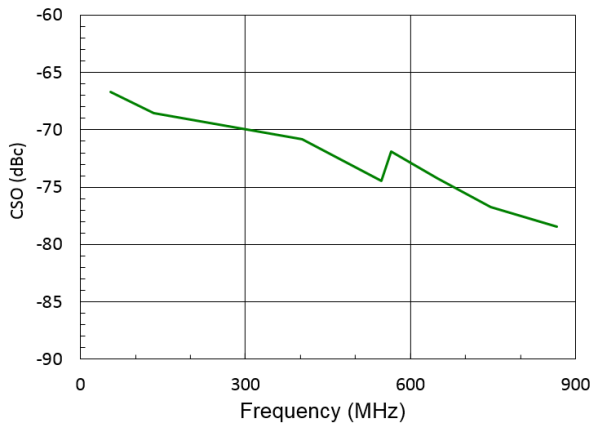

CSO Upper

132 analog ch, $P_{IN} = 15\text{ dBmV per ch, } +25^\circ\text{C}$

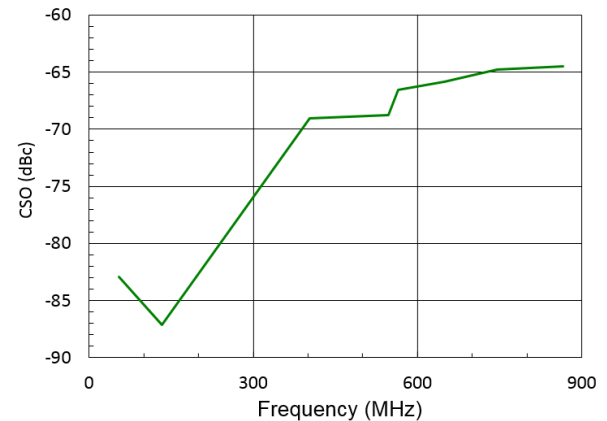

Lead Free SOT-89[†]

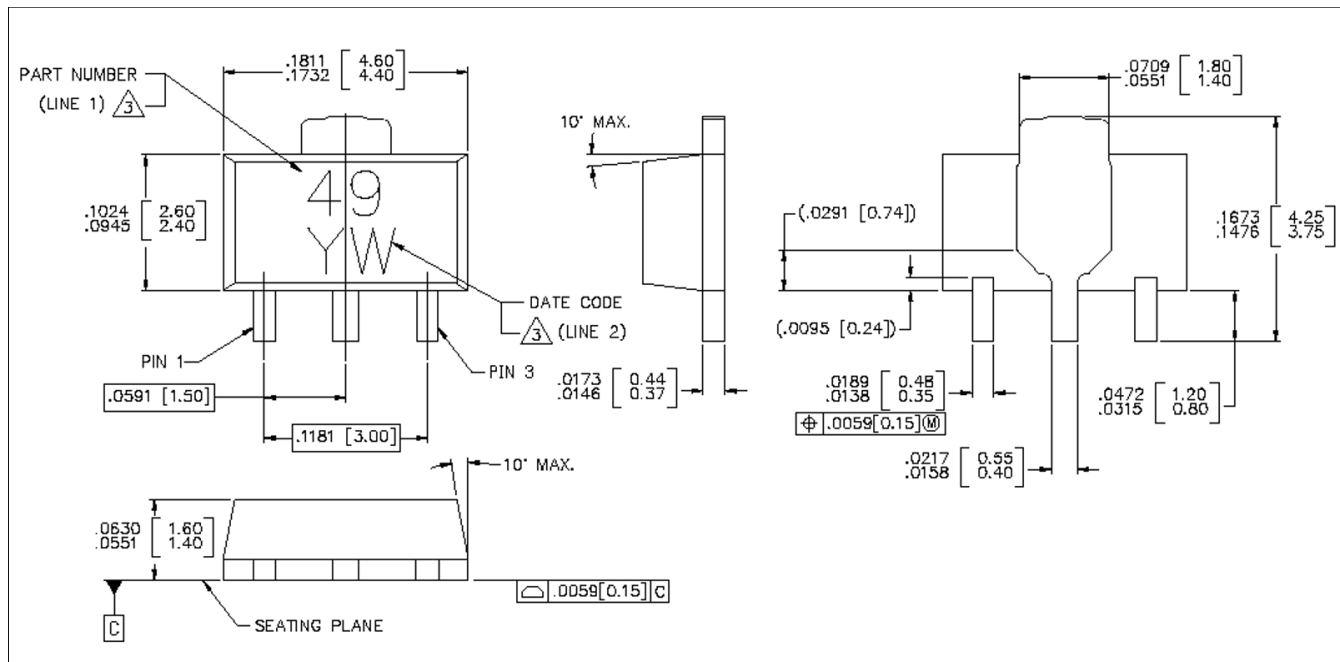

[†] Reference Application Note S2083 for lead-free solder reflow recommendations.
 Meets JEDEC moisture sensitivity level 1 requirements.
 Plating is 100% matte tin over copper.

M/A-COM Technology Solutions Inc. All rights reserved.

Information in this document is provided in connection with M/A-COM Technology Solutions Inc ("MACOM") products. These materials are provided by MACOM as a service to its customers and may be used for informational purposes only. Except as provided in MACOM's Terms and Conditions of Sale for such products or in any separate agreement related to this document, MACOM assumes no liability whatsoever. MACOM assumes no responsibility for errors or omissions in these materials. MACOM may make changes to specifications and product descriptions at any time, without notice. MACOM makes no commitment to update the information and shall have no responsibility whatsoever for conflicts or incompatibilities arising from future changes to its specifications and product descriptions. No license, express or implied, by estoppels or otherwise, to any intellectual property rights is granted by this document.

THESE MATERIALS ARE PROVIDED "AS IS" WITHOUT WARRANTY OF ANY KIND, EITHER EXPRESS OR IMPLIED, RELATING TO SALE AND/OR USE OF MACOM PRODUCTS INCLUDING LIABILITY OR WARRANTIES RELATING TO FITNESS FOR A PARTICULAR PURPOSE, CONSEQUENTIAL OR INCIDENTAL DAMAGES, MERCHANTABILITY, OR INFRINGEMENT OF ANY PATENT, COPYRIGHT OR OTHER INTELLECTUAL PROPERTY RIGHT. MACOM FURTHER DOES NOT WARRANT THE ACCURACY OR COMPLETENESS OF THE INFORMATION, TEXT, GRAPHICS OR OTHER ITEMS CONTAINED WITHIN THESE MATERIALS. MACOM SHALL NOT BE LIABLE FOR ANY SPECIAL, INDIRECT, INCIDENTAL, OR CONSEQUENTIAL DAMAGES, INCLUDING WITHOUT LIMITATION, LOST REVENUES OR LOST PROFITS, WHICH MAY RESULT FROM THE USE OF THESE MATERIALS.

MACOM products are not intended for use in medical, lifesaving or life sustaining applications. MACOM customers using or selling MACOM products for use in such applications do so at their own risk and agree to fully indemnify MACOM for any damages resulting from such improper use or sale.