

WNM3032
Single N-Channel, 30V, 9.6A , Power MOSFET
[Http://www.willsemi.com](http://www.willsemi.com)

V _{DS} (V)	R _{ds(on)} (mΩ)
30	8.5@ V _{GS} = 10V
	12@ V _{GS} = 4.5V
ESD Protected	

Descriptions

The WNM3032 is N-Channel enhancement MOS Field Effect Transistor. Uses advanced trench technology and design to provide excellent R_{DS (ON)} with low gate charge. This device is suitable for use in DC-DC conversion, power switch and charging circuit. Standard Product WNM3032 is Pb-free.

Features

- Trench Technology
- Supper high density cell design
- Excellent ON resistance for higher DC current
- Extremely Low Threshold Voltage
- Small package SOP-8L

Applications

- Driver for Relay, Solenoid, Motor, LED etc.
- DC-DC converter circuit
- Power Switch
- Load Switch
- Charging

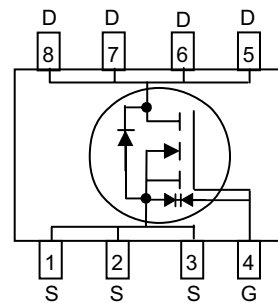
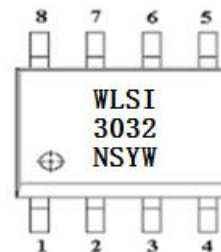
SOP-8L

Pin configuration (Top view)

WLSI = Company
 3032 = Device Code
 NS = Special Code
 YW = Date Code

Marking
Order information

Device	Package	Shipping
WNM3032-8/TR	SOP-8L	4000/Reel&Tape

Absolute Maximum ratings

Parameter	Symbol	10 s	Steady State	Unit	
Drain-Source Voltage	V_{DS}	30		V	
Gate-Source Voltage	V_{GS}	± 20			
Continuous Drain Current ^{a d}	I_D	$T_A=25^\circ\text{C}$	12.9	9.6	A
		$T_A=70^\circ\text{C}$	10.3	7.7	
Maximum Power Dissipation ^{a d}	P_D	$T_A=25^\circ\text{C}$	3.0	1.7	W
		$T_A=70^\circ\text{C}$	1.9	1.1	
Continuous Drain Current ^{b d}	I_D	$T_A=25^\circ\text{C}$	9.3	7.5	A
		$T_A=70^\circ\text{C}$	7.4	6.0	
Maximum Power Dissipation ^{b d}	P_D	$T_A=25^\circ\text{C}$	1.5	1.0	W
		$T_A=70^\circ\text{C}$	1.0	0.6	
Pulsed Drain Current ^c	I_{DM}	50		A	
Operating Junction Temperature	T_J	-55 to 150		$^\circ\text{C}$	
Lead Temperature	T_L	260		$^\circ\text{C}$	
Storage Temperature Range	T_{stg}	-55 to 150		$^\circ\text{C}$	

Thermal resistance ratings

Parameter	Symbol	Typical	Maximum	Unit	
Junction-to-Ambient Thermal Resistance ^a	$R_{\theta JA}$	$t \leq 10 \text{ s}$	32	42	$^\circ\text{C/W}$
		Steady State	59	75	
Junction-to-Ambient Thermal Resistance ^b	$R_{\theta JA}$	$t \leq 10 \text{ s}$	59	81	
		Steady State	95	125	
Junction-to-Case Thermal Resistance	$R_{\theta JC}$	35	45		

a Surface mounted on FR4 Board using 1 square inch pad size, 1oz copper

b Surface mounted on FR4 board using minimum pad size, 1oz copper

c Repetitive rating, pulse width limited by junction temperature, $t_p=10\mu\text{s}$, Duty Cycle=1%

d Repetitive rating, pulse width limited by junction temperature $T_J=150^\circ\text{C}$.

Electronics Characteristics (Ta=25°C, unless otherwise noted)

Parameter	Symbol	Test Conditions	Min	Typ	Max	Unit
OFF CHARACTERISTICS						
Drain-to-Source Breakdown Voltage	BV_{DSS}	$V_{GS} = 0\text{ V}, I_D = 250\mu\text{A}$	30			V
Zero Gate Voltage Drain Current	I_{DSS}	$V_{DS} = 24\text{ V}, V_{GS} = 0\text{ V}$			1	μA
Gate-to-source Leakage Current	I_{GSS}	$V_{DS} = 0\text{ V}, V_{GS} = \pm 20\text{ V}$			± 5	μA
ON CHARACTERISTICS						
Gate Threshold Voltage	$V_{GS(TH)}$	$V_{GS} = V_{DS}, I_D = 250\mu\text{A}$	1.0	1.4	2.0	V
Drain-to-source On-resistance	$R_{DS(on)}$	$V_{GS} = 10\text{ V}, I_D = 10\text{ A}$		8.5	12	m Ω
		$V_{GS} = 4.5\text{ V}, I_D = 8\text{ A}$		12	16	
CHARGES, CAPACITANCES AND GATE RESISTANCE						
Input Capacitance	C_{ISS}	$V_{GS} = 0\text{ V}, F = 1.0\text{ MHz}, V_{DS} = 15\text{ V}$		1375		pF
Output Capacitance	C_{OSS}			271		
Reverse Transfer Capacitance	C_{RSS}			233		
Total Gate Charge	$Q_{G(TOT)}$	$V_{GS} = 10\text{ V}, V_{DS} = 15\text{ V}, I_D = 10\text{ A}$		28.9		nC
Threshold Gate Charge	$Q_{G(TH)}$			1.3		
Gate-to-Source Charge	Q_{GS}			4.3		
Gate-to-Drain Charge	Q_{GD}			5.48		
SWITCHING CHARACTERISTICS						
Turn-On Delay Time	$t_d(ON)$	$V_{GS} = 10\text{ V}, V_{DS} = 15\text{ V}, R_G = 3\ \Omega, R_L = 0.75\ \Omega$		13.8		ns
Rise Time	t_r			10.2		
Turn-Off Delay Time	$t_d(OFF)$			63.2		
Fall Time	t_f			12.4		
BODY DIODE CHARACTERISTICS						
Forward Voltage	V_{SD}	$V_{GS} = 0\text{ V}, I_S = 1\text{ A}$	0.5	0.7	1.2	V

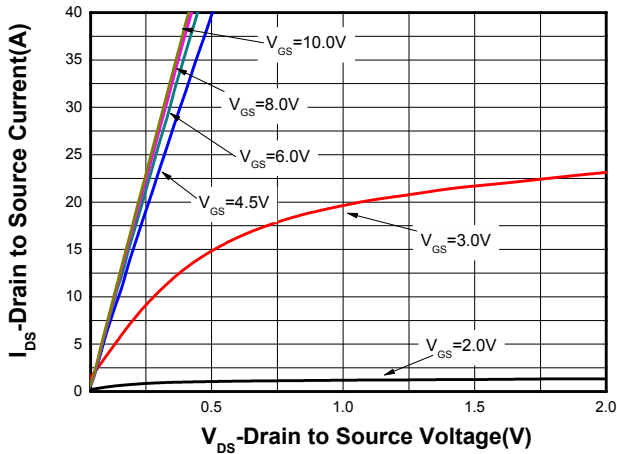
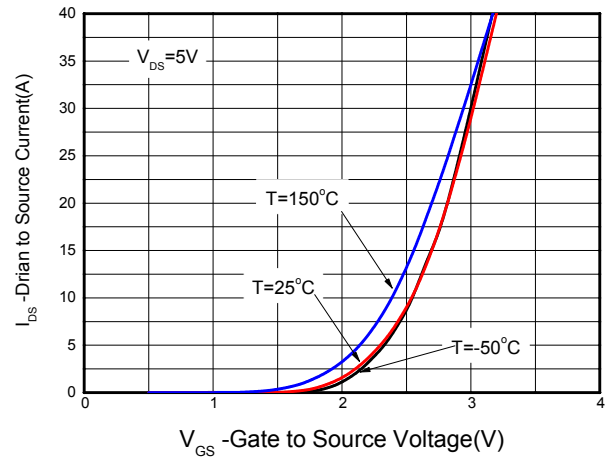
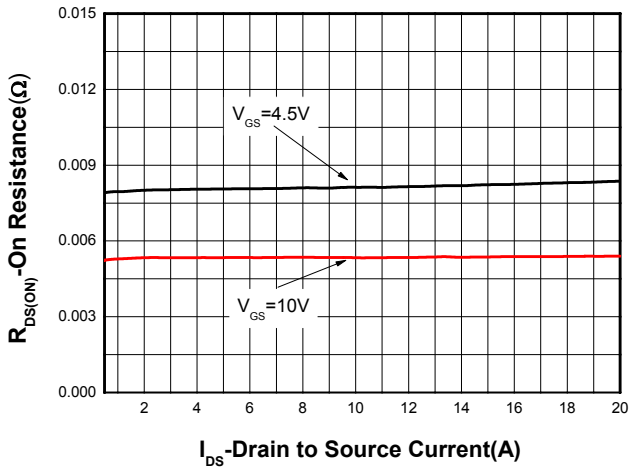
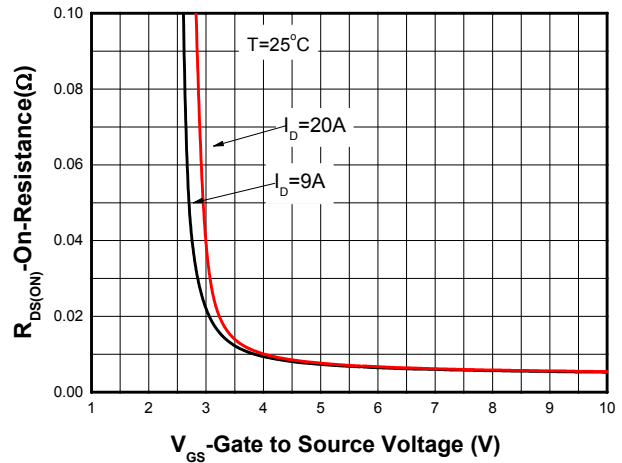
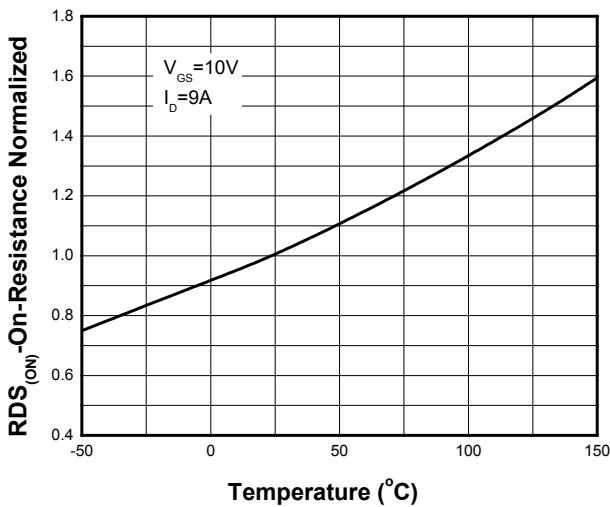
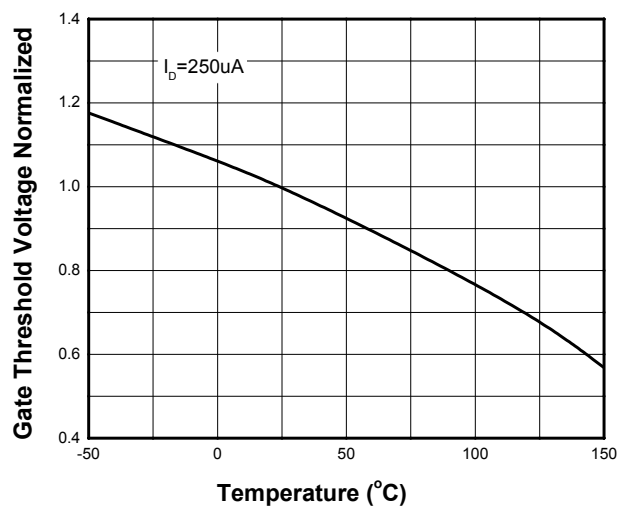
Typical Characteristics (Ta=25°C, unless otherwise noted)

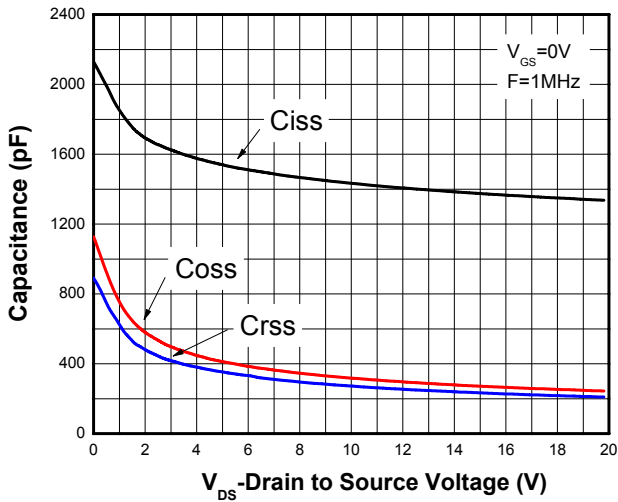
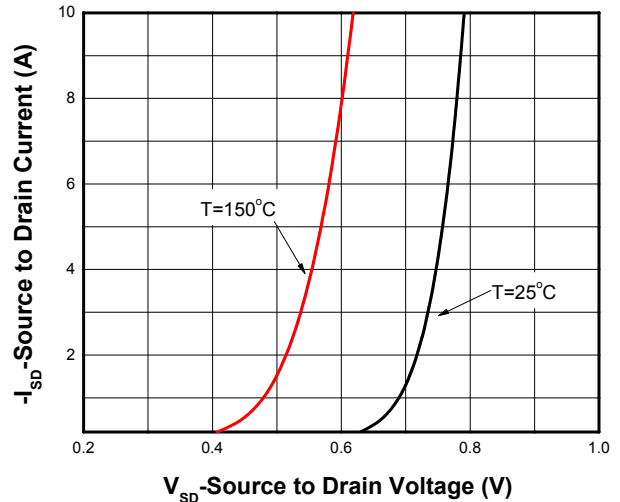
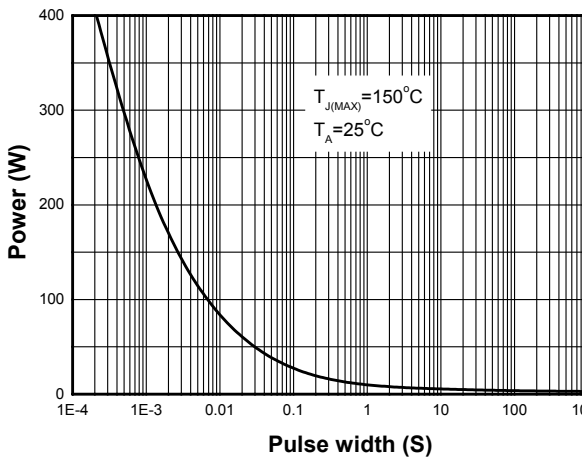
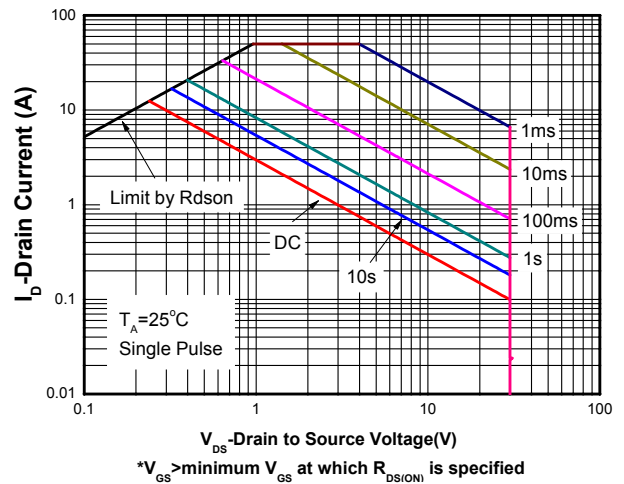
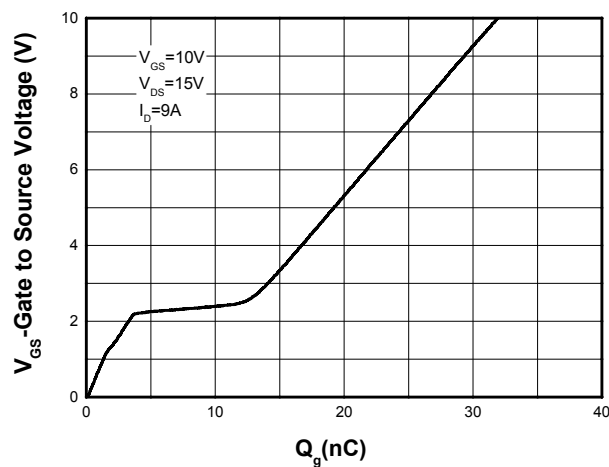
Output characteristics

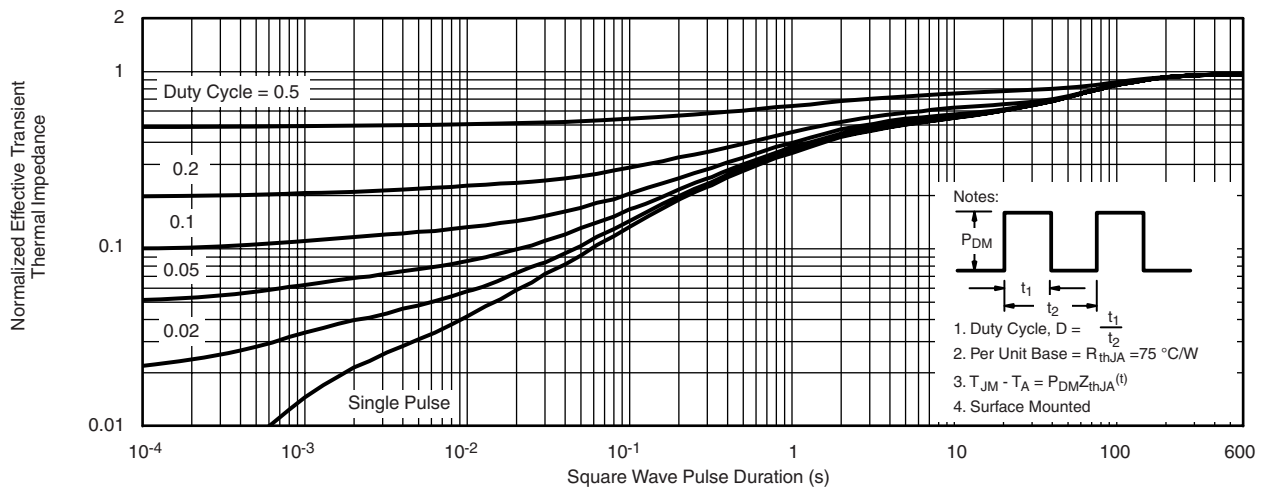
Transfer characteristics

On-Resistance vs. Drain current

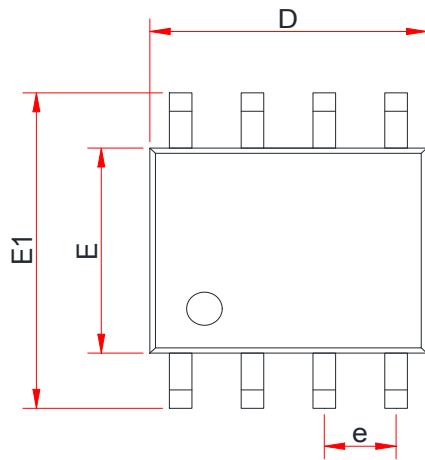
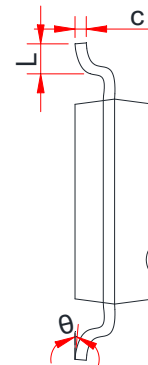
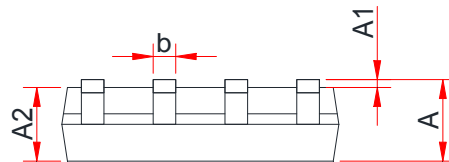
On-Resistance vs. Gate-to-source voltage

On-Resistance vs. Junction temperature

Threshold voltage vs. Temperature



Capacitance

Body diode forward voltage

Single pulse power

Safe operating power

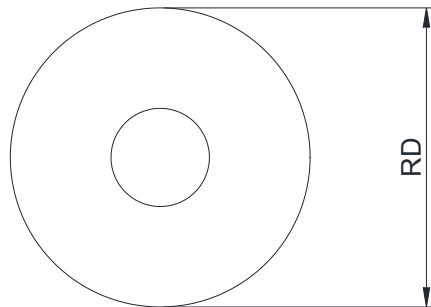
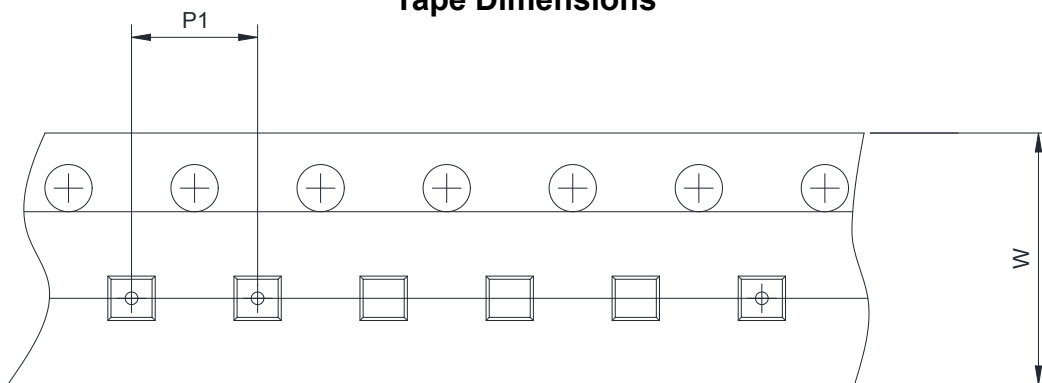
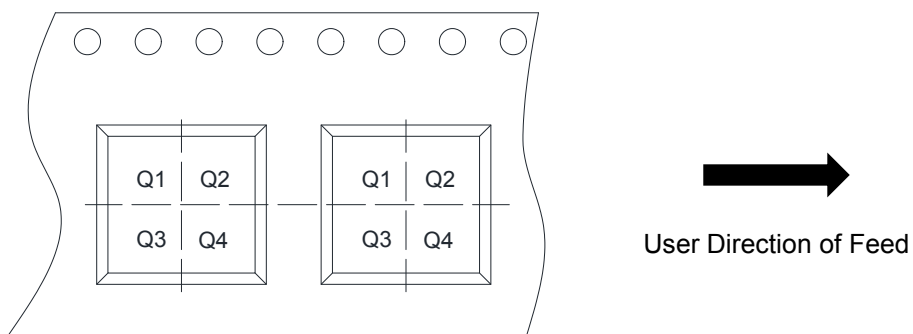
Gate Charge Characteristics



Normalized Thermal Transient Impedance, Junction-to-Ambient

Package outline dimensions
SOP-8L

TOP VIEW

SIDE VIEW

SIDE VIEW

Symbol	Dimensions In Millimeters (mm)		
	Min.	Typ.	Max.
A	1.35	1.55	1.75
A1	0.05	0.15	0.25
A2	1.25	1.40	1.65
b	0.33	-	0.51
c	0.15	-	0.26
D	4.70	4.90	5.10
E	3.70	3.90	4.10
E1	5.80	6.00	6.20
e	1.27BSC		
L	0.40	-	1.27
θ	0°	-	8°

TAPE AND REEL INFORMATION
Reel Dimensions

Tape Dimensions

Quadrant Assignments For PIN1 Orientation In Tape

RD	Reel Dimension	<input type="checkbox"/> 7inch	<input checked="" type="checkbox"/> 13inch		
W	Overall width of the carrier tape	<input type="checkbox"/> 8mm	<input checked="" type="checkbox"/> 12mm		
P1	Pitch between successive cavity centers	<input type="checkbox"/> 2mm	<input type="checkbox"/> 4mm	<input checked="" type="checkbox"/> 8mm	
Pin1	Pin1 Quadrant	<input checked="" type="checkbox"/> Q1	<input type="checkbox"/> Q2	<input type="checkbox"/> Q3	<input type="checkbox"/> Q4