

## CMOS LDO Regulators for Portable Equipments

## 1ch 150mA

## CMOS LDO Regulators



BH□□RB1WGUT series

No.11020ECT03

**●Description**

The BH□□RB1WGUT series is a line of 150 mA output CMOS regulators that deliver a highly stable precision ( $\pm 1\%$ ) output voltage. Proprietary ROHM technology enables a small load regulation of 2 mV and a dropout voltage of 100 mV.

At just 1.0 mm  $\times$  1.04 mm, the new VCSP60N1 package is extremely compact, and the IC's enhanced protection circuits contribute to improved end products characteristics.

**●Features**

- 1) High accuracy output voltage:  $\pm 1\%$
- 2) Dropout voltage: 100 mV (at 100 mA)
- 3) Stable with ceramic capacitors
- 4) Low bias current: 34  $\mu$ A
- 5) High ripple rejection ratio: 63 dB (Typ., 1 kHz)
- 6) Output voltage on/off control
- 7) Built-in overcurrent and thermal shutdown circuits
- 8) VCSP60N1 WL-CSP package : (1.0  $\times$  1.04  $\times$  0.6mm)

**●Applications**

Battery-driven portable devices, etc.

**●Product line**
**■150 mA BH□□RB1WGUT Series**

Product name	1.5	1.8	2.5	2.8	2.9	3.0	3.1	3.3	Package
BH□□RB1WGUT	√	√	√	√	√	√	√	√	VCSP60N1

Model name: BH□□RB1W□  
                   a      b

Symbol	Description			
a	Output voltage specification			
	□□	Output voltage (V)	□□	Output voltage (V)
	15	1.5 V (Typ.)	29	2.9 V (Typ.)
	18	1.8 V (Typ.)	30	3.0 V (Typ.)
	25	2.5 V (Typ.)	31	3.1 V (Typ.)
	28	2.8 V (Typ.)	33	3.3 V (Typ.)
b	Package GUT: VCSP60N1			

## ● Absolute maximum ratings

Parameter	Symbol	Ratings	Unit
Applied supply voltage	VMAX	-0.3 to +6.5	V
Power dissipation	Pd	530 <sup>*1</sup>	mW
Operating temperature range	Topr	-40 to +85	°C
Storage temperature range	Tstg	-55 to +125	°C

\*1: Reduce by 5.3 mW/°C over 25°C, when mounted on a glass epoxy PCB (7 mm × 7 mm × 0.8 mm).

## ● Recommended operating ranges (not to exceed Pd)

Parameter	Symbol	Ratings	Unit
Power supply voltage	VIN	2.5 to 5.5	V
Output current	IOUT	0 to 150	mA

## ● Recommended operating conditions

Parameter	Symbol	Ratings			Unit	Conditions
		Min.	Typ.	Max.		
Input capacitor	CIN	0.7 <sup>*2</sup>	1.0	—	μF	The use of ceramic capacitors is recommended.
Output capacitor	Co	0.7 <sup>*2</sup>	1.0	—	μF	The use of ceramic capacitors is recommended.

\*2: Make sure that the output capacitor value is not kept lower than this specified level across a variety of temperature, DC bias characteristic. And also make sure that the capacitor value cannot change as time progresses.

## ● Electrical characteristics

(Unless otherwise specified, Ta = 25°C, VIN = VOUT + 1.0 V<sup>\*5</sup>, STBY = 1.5 V, CIN = 1 μF, Co = 1 μF)

Parameter	Symbol	Limits			Unit	Conditions	
		Min.	Typ.	Max.			
Output voltage 1	VOUT1	VOUT × 0.99	VOUT	VOUT × 1.01	V	IOUT = 1 mA, Ta = 25°C, BH25RB1WGUT or higher	
		VOUT - 25 mV		VOUT + 25 mV		IOUT = 1 mA, Ta = 25°C, BH15, 18RB1WGUT	
Output voltage 2	VOUT2	VOUT × 0.97	VOUT	VOUT × 1.03	V	IOUT = 1 mA Ta = -40°C to 85°C <sup>*3</sup>	
Circuit current	IGND	—	34	72	μA	IOUT = 0 mA Ta = -40°C to 85°C <sup>*3</sup>	
Circuit current (STBY)	ICCST	—	—	1.0	μA	STBY = 0 V	
Ripple rejection ratio	RR	—	63	—	dB	VRR = -20 dBV, fRR = 1 kHz, IOUT = 10 mA	
Dropout voltage	VSAT	—	100	150	mV	VIN = 0.98 × VOUT, IOUT = 100 mA (Excluding BH15, 18RB1WGUT)	
Line regulation	VDLI	—	2	20	mV	IOUT = 10 mA VIN = VOUT + 0.5 V to 5.5 V <sup>*4</sup>	
Load regulation	VDLO	—	2	30	mV	IOUT = 1 mA to 100 mA	
Overcurrent protection limit current	ILMAX	—	300	—	mA	Vo = VOUT × 0.98	
Short current	ISHORT	—	40	—	mA	Vo = 0 V	
STBY pin current	ISTBY	0.5	1.3	3.6	μA	Ta = -40°C to 85°C <sup>*3</sup>	
STBY control voltage	ON	VSTBH	1.2	—	VIN	V	Ta = -40°C to 85°C <sup>*3</sup>
	OFF	VSTBL	-0.2	—	0.2	V	Ta = -40°C to 85°C <sup>*3</sup>

\* This IC is not designed to be radiation-resistant.

\*3: These specifications are guaranteed by design.

\*4: For BH15, 18RB1WGUT, VIN = 3.0 V to 5.5 V.

\*5: For BH15, 18RB1WGUT, VIN = 3.5 V.

● Typical characteristics

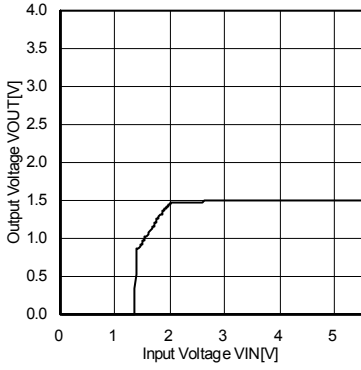

Fig. 1 Output Voltage vs Input Voltage (BH15RB1WGUT)

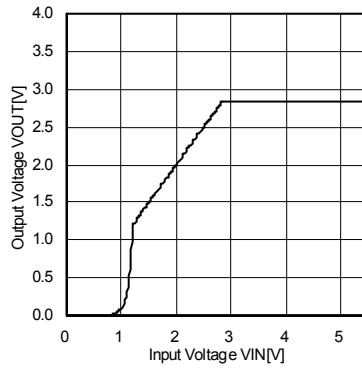

Fig. 2 Output Voltage vs Input Voltage (BH28RB1WGUT)

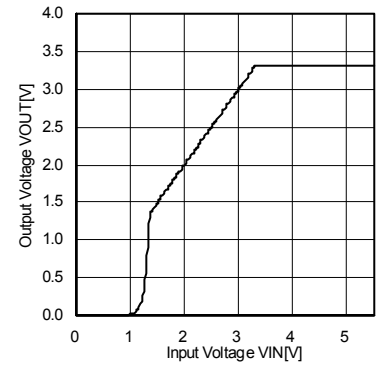

Fig. 3 Output Voltage vs Input Voltage (BH33RB1WGUT)

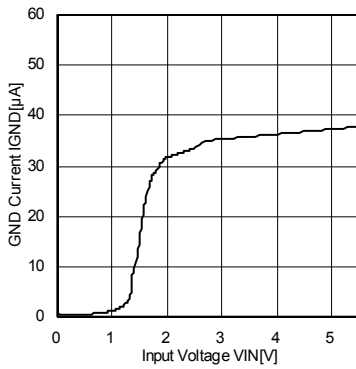

Fig. 4 GND Current vs Input Voltage (BH15RB1WGUT)

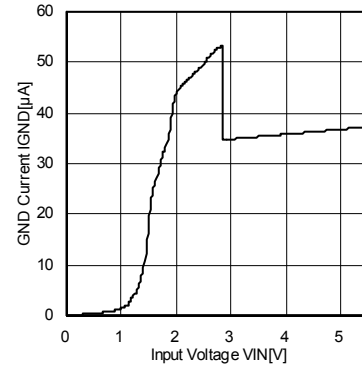

Fig. 5 GND Current vs Input Voltage (BH28RB1WGUT)

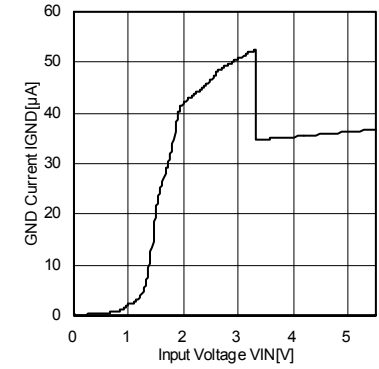

Fig. 6 GND Current vs Input Voltage (BH33RB1WGUT)

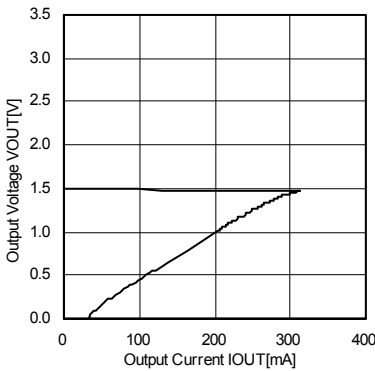

Fig. 7 Output Voltage vs Output Current (BH15RB1WGUT)

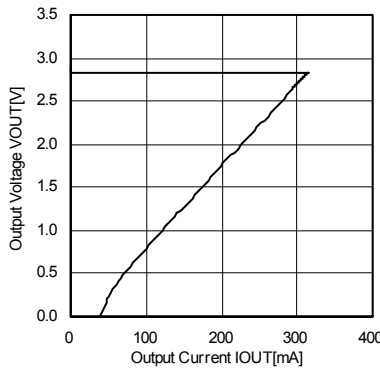

Fig. 8 Output Voltage vs Output Current (BH28RB1WGUT)

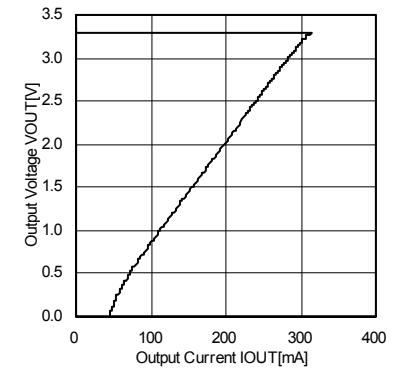

Fig. 9 Output Voltage vs Output Current (BH33RB1WGUT)

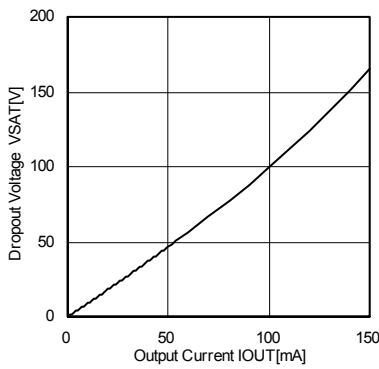

Fig. 10 Dropout Voltage vs Output Current (BH28RB1WGUT)

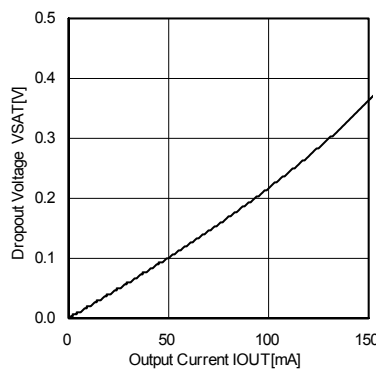

Fig. 11 Dropout Voltage vs Output Current (BH33RB1WGUT)

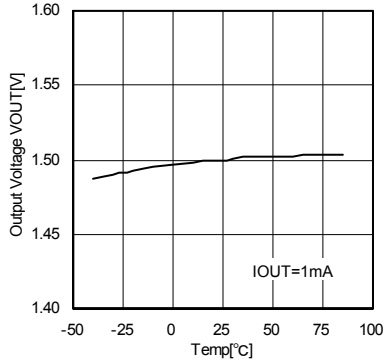

Fig. 12 Output Voltage vs Temperature (BH15RB1WGUT)

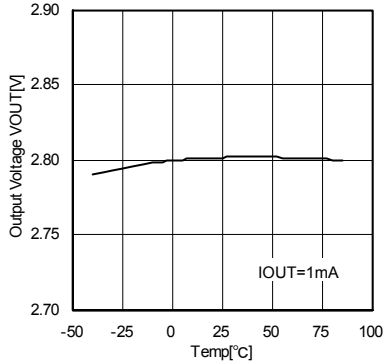

Fig. 13 Output Voltage vs Temperature (BH28RB1WGUT)

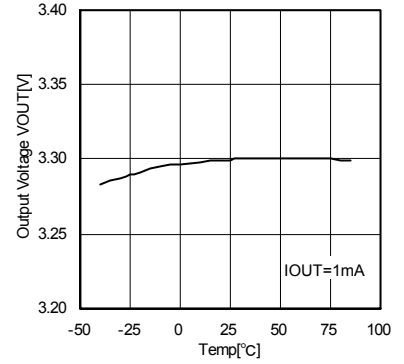

Fig. 14 Output Voltage vs Temperature (BH33RB1WGUT)

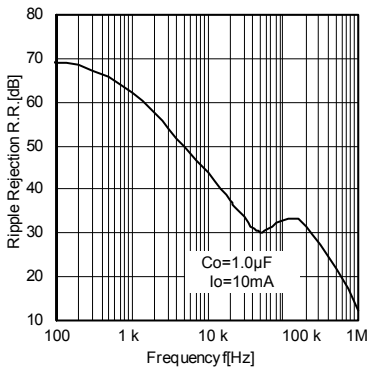

Fig. 15 Ripple Rejection (BH15RB1WGUT)

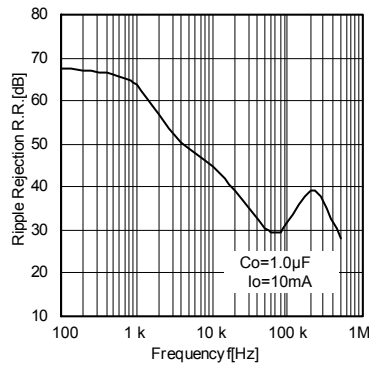

Fig. 16 Ripple Rejection (BH28RB1WGUT)

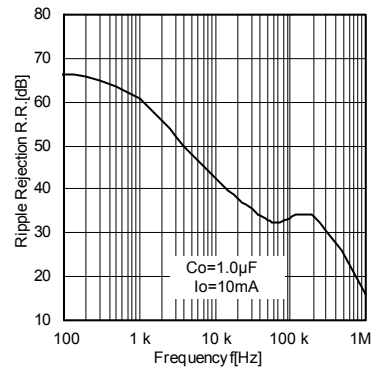

Fig. 17 Ripple Rejection (BH33RB1WGUT)

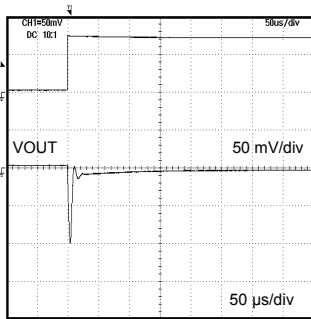

Fig. 18 Load Response (Co = 1.0 µF) (BH15RB1WGUT)

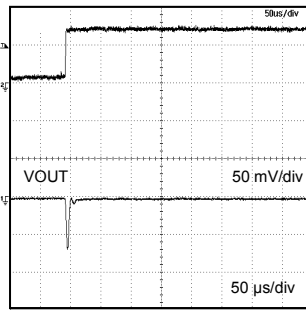

Fig. 19 Load Response (Co = 1.0 µF) (BH28RB1WGUT)

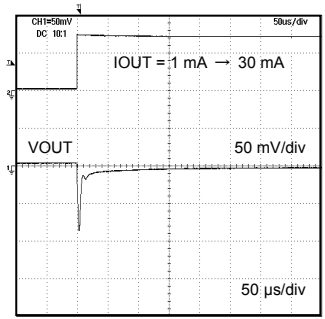

Fig. 20 Load Response (Co = 1.0 µF) (BH33RB1WGUT)

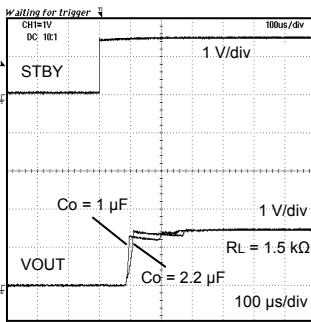

Fig. 21 Output Voltage Rise Time (BH15RB1WGUT)

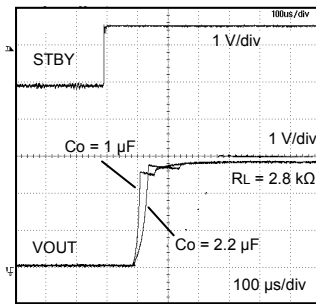

Fig. 22 Output Voltage Rise Time (BH28RB1WGUT)

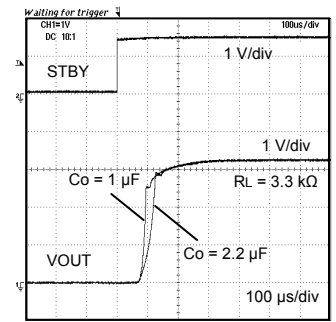
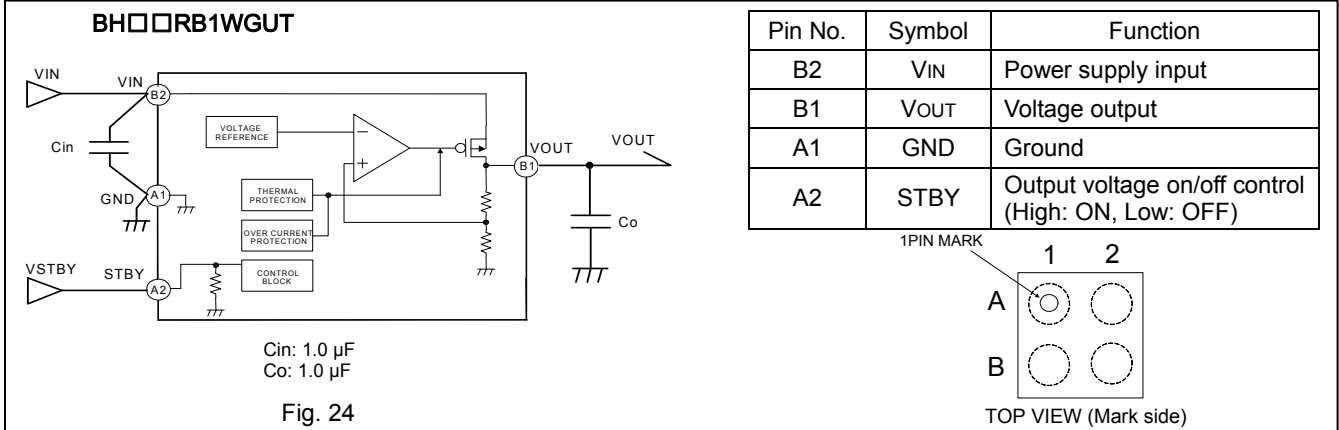

Fig. 23 Output Voltage Rise Time (BH33RB1WGUT)

●Block Diagram, Recommended Circuit Diagram, and Pin Assignment Diagram



●Power Dissipation (Pd)

1. Power dissipation (Pd)

Power dissipation calculations include output power dissipation characteristics and internal IC power consumption. In the event that the IC is used in an environment where this power dissipation is exceeded, the attendant rise in the junction temperature will trigger the thermal shutdown circuit, reducing the current capacity and otherwise degrading the IC's design performance. Allow for sufficient margins so that this power dissipation is not exceeded during IC operation.

Calculating the maximum internal IC power consumption (P<sub>MAX</sub>)

$$P_{MAX} = (V_{IN} - V_{OUT}) \times I_{OUT} (MAX.)$$

V<sub>IN</sub>: Input voltage  
V<sub>OUT</sub>: Output voltage  
I<sub>OUT</sub> (MAX): Output current

2. Power dissipation/power dissipation reduction (Pd)

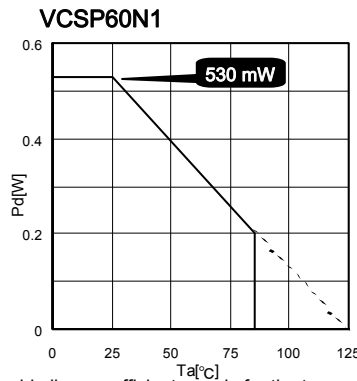

Board: 7 mm × 7 mm × 0.8 mm  
Material: Glass epoxy PCB

\*Circuit design should allow a sufficient margin for the temperature range for P<sub>MAX</sub> < Pd.

Fig. 25 VCSP60N1 Power Dissipation/Power Dissipation Reduction (Example)

●Input Output Capacitors

It is recommended to insert bypass capacitors between input and GND pins, positioning them as close to the pins as possible. These capacitors are used when the power supply impedance increases or when long wiring paths are used, so they should be checked once the IC has been mounted. Ceramic capacitors generally have temperature and DC bias characteristics. Use X5R or X7R ceramic capacitors, which offer good temperature and DC bias characteristics as well as stable high voltages.

Typical ceramic capacitor characteristics

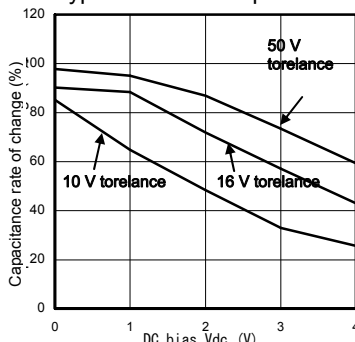

Fig. 26 Capacitance vs Bias (Y5V)

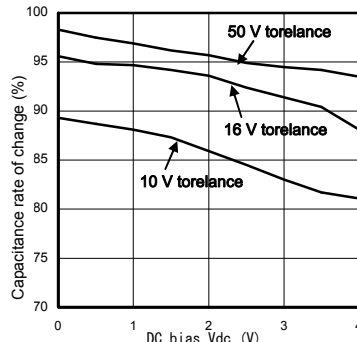

Fig.27 Capacitance vs Bias (X5R, X7R)

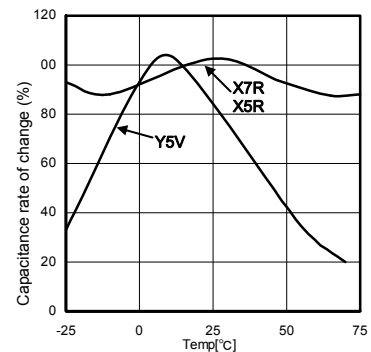

Fig. 28 Capacitance vs Temperature (X5R, X7R, Y5V)

### ●Output capacitors

Mounting input capacitor between input pin and GND (as close to pin as possible), and also output capacitor between output pin and GND(as close to pin as possible) is recommended. The input capacitor reduces the output impedance of the voltage supply source connected to the VCC. The higher value the output capacitor goes the more stable the whole operation becomes. This leads to high load transient response. Please confirm the whole operation on actual application board. Generally, ceramic capacitor has wide range of tolerance, temperature coefficient, and DC bias characteristic. And also its value goes lower as time progresses. Please choose ceramic capacitors after obtaining more detailed data by asking capacitor makers.

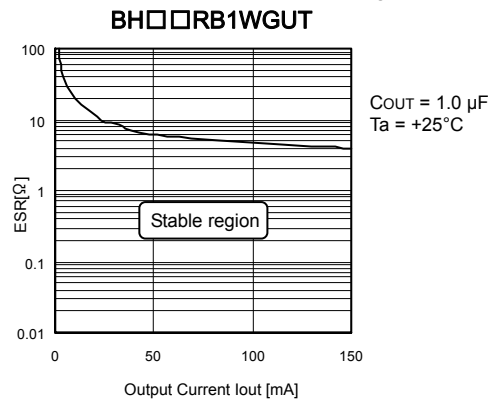

Fig. 29 Stable Operating Region Characteristics (Example)

### ●Operation Notes

#### 1. Absolute maximum ratings

An excess in the absolute maximum ratings, such as supply voltage, temperature range of operating conditions, etc., can break down the devices, thus making impossible to identify breaking mode, such as a short circuit or an open circuit. If any over rated values will expect to exceed the absolute maximum ratings, consider adding circuit protection devices, such as fuses.

#### 2. Thermal design

Use a thermal design that allows for a sufficient margin in light of the power dissipation (Pd) in actual operating conditions.

#### 3. Inter-pin shorts and mounting errors

Use caution when positioning the IC for mounting on printed circuit boards. The IC may be damaged if there is any connection error or if pins are shorted together.

#### 4. Thermal shutdown circuit (TSD)

The IC incorporates a built-in thermal shutdown circuit (TSD circuit). The thermal shutdown circuit is designed only to shut the IC off to prevent runaway thermal operation. It is not designed to protect the IC or guarantee its operation. Do not continue to use the IC after operating this circuit or use the IC in an environment where the operation of this circuit is assumed.

#### 5. Overcurrent protection circuit

The IC incorporates a built-in overcurrent protection circuit that operates according to the output current capacity. This circuit serves to protect the IC from damage when the load is shorted. The protection circuit is designed to limit current flow by not latching in the event of a large and instantaneous current flow originating from a large capacitor or other component. These protection circuits are effective in preventing damage due to sudden and unexpected accidents. However, the IC should not be used in applications characterized by the continuous operation or transitioning of the protection circuits. At the time of thermal designing, keep in mind that the current capability has negative characteristics to temperatures.

#### 6. Actions in strong electromagnetic field

Use caution when using the IC in the presence of a strong electromagnetic field as doing so may cause the IC to malfunction.

#### 7. Ground wiring patterns

When using both small signal and large current GND patterns, it is recommended to isolate the two ground patterns, placing a single ground point at the ground potential of application so that the pattern wiring resistance and voltage variations caused by large currents do not cause variations in the small signal ground voltage. Be careful not to change the GND wiring pattern of any external components, either.

#### 8. Influence of strong light

Exposure of the IC to strong light sources such as infrared light from a halogen lamp may cause the IC to malfunction. When it is necessary to use the IC in such environments, implement measures to block exposure to light from the light source. During testing, exposure to neither fluorescent lighting nor white LEDs had a significant effect on the IC.

9. GND voltage

The potential of GND pin must be minimum potential in all operating conditions.

10. Back Current

In applications where the IC may be exposed to back current flow, it is recommended to create a path to dissipate this current by inserting a bypass diode between the VIN and VOUT pins.

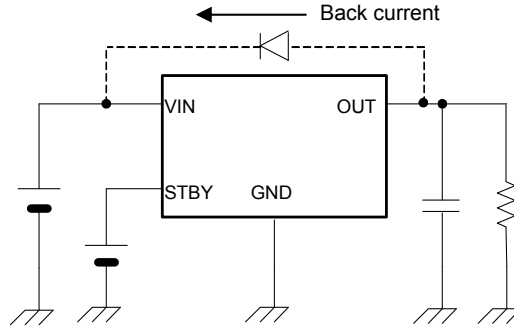

Fig. 30 Example Bypass Diode Connection

11. Testing on application boards

When testing the IC on an application board, connecting a capacitor to a pin with low impedance subjects the IC to stress. Always discharge capacitors after each process or step. Always turn the IC's power supply off before connecting it to or removing it from a jig or fixture during the inspection process. Ground the IC during assembly steps as an antistatic measure. Use similar precaution when transporting or storing the IC.

12. Regarding Input Pin of the IC (Fig.31)

This monolithic IC contains P+ isolation and P substrate layers between adjacent elements in order to keep them isolated. P-N junctions are formed at the intersection of these P layers with the N layers of other elements, creating a parasitic diode or transistor. For example, the relation between each potential is as follows:

When  $GND > Pin A$  and  $GND > Pin B$ , the P-N junction operates as a parasitic diode.

When  $GND > Pin B$ , the P-N junction operates as a parasitic transistor.

Parasitic diodes can occur inevitable in the structure of the IC. The operation of parasitic diodes can result in mutual interference among circuits, operational faults, or physical damage. Accordingly, methods by which parasitic diodes operate, such as applying a voltage that is lower than the GND (P substrate) voltage to an input pin, should not be used.

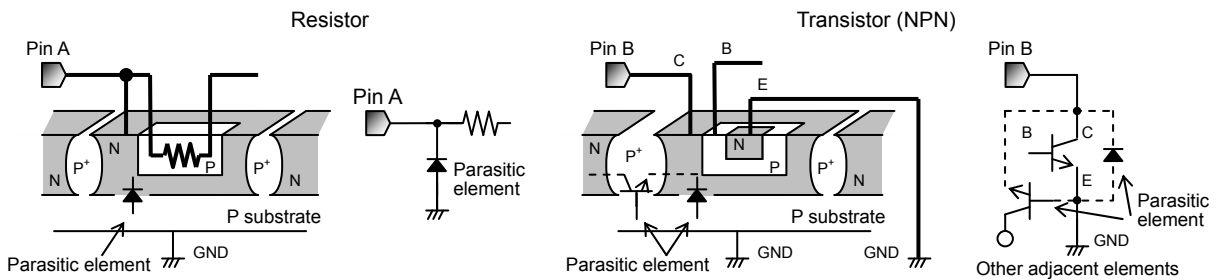
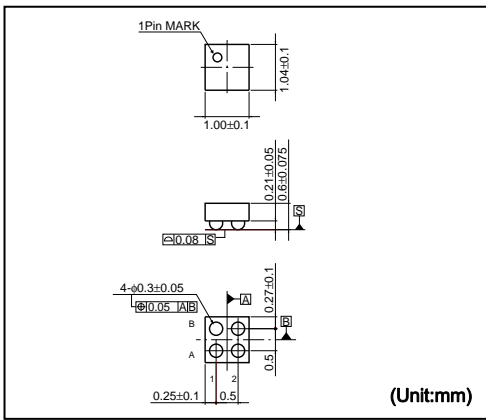

Fig. 31 Example of IC structure

●Ordering part number

B	H	1	5	R	B	1	W	G	U	T	-	E	2
Part No.		Output voltage 15: 1.5 V 18: 1.8 V 25: 2.5 V 28: 2.8 V 29: 2.9 V 30: 3.0 V 31: 3.1 V 33: 3.3 V		Series RB1 : High ripple rejection			Shutdown switch W : Includes switch	Package GUT: VCSP60N1			Packaging and forming specification E2: Embossed tape and reel		

VCSP60N1



<Tape and Reel information>

Tape	Embossed carrier tape
Quantity	3000pcs
Direction of feed	E2 (The direction is the 1pin of product is at the upper left when you hold reel on the left hand and you pull out the tape on the right hand.)

※When you order , please order in times the amount of package quantity.



## Notes

No copying or reproduction of this document, in part or in whole, is permitted without the consent of ROHM Co.,Ltd.

The content specified herein is subject to change for improvement without notice.

The content specified herein is for the purpose of introducing ROHM's products (hereinafter "Products"). If you wish to use any such Product, please be sure to refer to the specifications, which can be obtained from ROHM upon request.

Examples of application circuits, circuit constants and any other information contained herein illustrate the standard usage and operations of the Products. The peripheral conditions must be taken into account when designing circuits for mass production.

Great care was taken in ensuring the accuracy of the information specified in this document. However, should you incur any damage arising from any inaccuracy or misprint of such information, ROHM shall bear no responsibility for such damage.

The technical information specified herein is intended only to show the typical functions of and examples of application circuits for the Products. ROHM does not grant you, explicitly or implicitly, any license to use or exercise intellectual property or other rights held by ROHM and other parties. ROHM shall bear no responsibility whatsoever for any dispute arising from the use of such technical information.

The Products specified in this document are intended to be used with general-use electronic equipment or devices (such as audio visual equipment, office-automation equipment, communication devices, electronic appliances and amusement devices).

The Products specified in this document are not designed to be radiation tolerant.

While ROHM always makes efforts to enhance the quality and reliability of its Products, a Product may fail or malfunction for a variety of reasons.

Please be sure to implement in your equipment using the Products safety measures to guard against the possibility of physical injury, fire or any other damage caused in the event of the failure of any Product, such as derating, redundancy, fire control and fail-safe designs. ROHM shall bear no responsibility whatsoever for your use of any Product outside of the prescribed scope or not in accordance with the instruction manual.

The Products are not designed or manufactured to be used with any equipment, device or system which requires an extremely high level of reliability the failure or malfunction of which may result in a direct threat to human life or create a risk of human injury (such as a medical instrument, transportation equipment, aerospace machinery, nuclear-reactor controller, fuel-controller or other safety device). ROHM shall bear no responsibility in any way for use of any of the Products for the above special purposes. If a Product is intended to be used for any such special purpose, please contact a ROHM sales representative before purchasing.

If you intend to export or ship overseas any Product or technology specified herein that may be controlled under the Foreign Exchange and the Foreign Trade Law, you will be required to obtain a license or permit under the Law.



Thank you for your accessing to ROHM product informations.  
More detail product informations and catalogs are available, please contact us.

## ROHM Customer Support System

<http://www.rohm.com/contact/>