

NON-ISOLATED DC/DC CONVERTERS

12V Input / 0.9V – 5.0V Output / 2A



BP05xRAH-02A

SRAH-02A / VRAH-02A Series

- Nonisolated
- Compact, low profile surface mount package
- Fixed frequency
- High efficiency means less power dissipation
- Excellent thermal performance
- Optimized for cost
- Remote on/off
- Undervoltage lockout (UVLO)
- Over current and short circuit protection
- Industrial temperature range

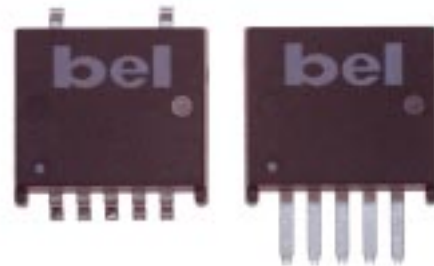

Description

The Bel SRAH-02A and VRAH-02A modules are a series of non-isolated, step down DC/DC power converters that operate from a nominal 12V source. These converters are available in a range of output voltages from 0.9V to 5.0V. They are packaged in a compact, overmolded package rated at 2A. Optional lead forming provides a vertical mount product for minimal footprint or a surface mount option for a very low profile. Standard features include remote on/off, over current and short circuit protection, output voltage adjust and industrial temperature ranges (-40° to +85° C). The output is closely regulated and the efficiency is typically 89% at full load. These products may be used almost anywhere low voltage silicon is employed and a 12V source is available. Typical applications include file servers, routers, line cards and other computing and communications equipment.

Applications

- Distributed power architectures
- Data networking equipment
- Telecommunications
- Computers and peripherals

Part Number Selection

Output Voltage	Input Voltage	Max. Output Current	Max. Output Power	Typical Efficiency	Part Number Surface Mount	Part Number Vertical Mount
5.0V	12V	2A	10W	89%	SRAH-02A500	VRAH-02A500
5.0V	12V	2A	10W	89%	SRAH-02A50F*	VRAH-02A50F*
3.3V	12V	2A	6.6W	88%	SRAH-02A330	VRAH-02A330
2.5V	12V	2A	5.0W	86%	SRAH-02A250	VRAH-02A250
1.8V	12V	2A	3.6W	82%	SRAH-02A180	VRAH-02A180
1.5V	12V	2A	3.0W	78%	SRAH-02A150	VRAH-02A150
1.2V	12V	2A	2.4W	74%	SRAH-02A120	VRAH-02A120
0.9V	12V	2A	1.8W	70%	SRAH-02A090	VRAH-02A090
0.9 ~ 3.63V	12V	2A	7.3W	70%	SRAH-02A1A0	VRAH-02A1A0
0.9 ~ 3.63V	12V	2A	7.3W	70%	SRAH-02A1AF*	VRAH-02A1AF*

* F indicates fast start up.

BP05xRAH-02A

Absolute Maximum Ratings

Parameter	Symbol	Min	Typical	Max	Unit
Continuous Input Voltage	Vin	-0.3		15	V
Output Enable Terminal Voltage	Vouten	-0.3		15	V
Ambient Temperature	Tamb	-40		85	°C
Storage Temperature	Tstor	-55		125	°C

Note: Use beyond the maximum ratings may cause a reliability degradation of the DC/DC converter or may permanently damage the device.

Input Specifications

Parameter	Module	Symbol	Min	Typical	Max	Units
Operating Input Voltage	All	Vin	10.8		13.2	V
Input Current	5.0V 3.3V 2.5V 1.8V 1.5V 1.2V 0.9V	lin			1.2 0.85 0.7 0.5 0.45 0.4 0.35	A
No Load Input Current	All				50	mA
Remote Off Input Current	All			3	10	mA
Input Reflected Ripple Current ¹	All			100		mA _{rms}
Input Reflected Ripple Current (P-P) ¹	All			300		mApk
I ² t Inrush Current Transient	All			0.01	0.02	A ² s
Turn On Voltage Threshold	All			9.6		V
Turn Off Voltage Threshold	All		8.8		9.8	V

Note: 1. Use a 47uF/25V tan capacitor at the input.

NON-ISOLATED DC/DC CONVERTERS

12V Input / 0.9V – 5.0V Output / 2A



BP05xRAH-02A

Output Specifications

Parameter	Module	Symbol	Min	Typical	Max	Units
Output Voltage Set Point ¹	5.0V	Vout	4.9	5.0	5.1	V
	3.3V		3.247	3.3	3.353	
	2.5V		2.460	2.5	2.540	
	1.8V		1.771	1.8	1.829	
	1.5V		1.476	1.5	1.524	
	1.2V		1.181	1.2	1.219	
	0.9V		0.886	0.9	0.914	
Load Regulation	5.0V			15	30	mV
	3.3V			10	30	
	2.5V			8	20	
	1.8V			5	10	
	1.5V			5	10	
	1.2V			4	10	
	0.9V			3	10	
Line Regulation	5.0V			2	5	mV
	3.3V			2	5	
	2.5V			2	5	
	1.8V			1	5	
	1.5V			1	5	
	1.2V			1	5	
	0.9V			1	5	
Regulation Over Temperature (-40° to 85° C)	5.0V			35	45	mV
	3.3V			35	45	
	2.5V			20	30	
	1.8V			15	25	
	1.5V			10	20	
	1.2V			8	15	
	0.9V			2	5	
Total Output Voltage Regulation (-40° to 85° C)	5.0V			52	80	mV
	3.3V			47	80	
	2.5V			30	55	
	1.8V			21	40	
	1.5V			16	35	
	1.2V			13	30	
	0.9V			6	20	

Note: All specifications are typical at nominal input, full load at 25° C unless otherwise stated.

1. Vin=12V, Iout=half load, Ta=25° C.

BP05xRAH-02A

Output Specifications

Parameter	Module	Symbol	Min	Typical	Max	Units
Output Ripple and Noise ²	5.0V			60	80	mVp-p
	3.3V			60	80	
	2.5V			50	70	
	1.8V			40	60	
	1.5V			35	60	
	1.2V			35	60	
	0.9V			35	60	
Output Ripple and Noise ²	5.0V			25	35	mVrms
	3.3V			20	35	
	2.5V			15	25	
	1.8V			15	25	
	1.5V			15	25	
	1.2V			10	20	
	0.9V			10	20	
Output Current Range	All	I _{out}	0		2	A
Output DC Current Limit	All	I _{outlim}	2.5		6	A
Short Circuit Surge	5.0V	I _{outsurge}		0.4	0.8	A ² s
	3.3V			0.4	0.8	
	2.5V			0.4	0.8	
	1.8V			0.5	1.0	
	1.5V			0.5	1.0	
	1.2V			0.5	1.0	
	0.9V			0.55	1.1	
Turn on Time	0.9V - 3.63V	T _{on}		70	100	ms
	5.0V			20	40	
Turn on Time ³		T _{on}		10	20	ms
Overshoot at Turn On	All			0	3	%
Overshoot at Turn On ³	1.5V - 5.0V			0	3	%
	0.9V - 1.2V			0	10	
Output Capacitance	All	C _{out}	100		1000	μF

Note: All specifications are typical at nominal input, full load at 25° C unless otherwise stated.

2. 0 - 20MHz BW with 100uF tan cap and 1uF ceramic cap.

3. For fast startup modules.

NON-ISOLATED DC/DC CONVERTERS

12V Input / 0.9V – 5.0V Output / 2A



BP05xRAH-02A

Output Specifications

Parameter	Module	Symbol	Min	Typical	Max	Units
Transient Response ³						
ΔV 50% to 100% of Max Load	5.0V			150	200	mV
Settling Time		Ts		100	140	μs
ΔV 100% to 50% of Max Load				150	200	mV
Settling Time		Ts		100	140	μs
Transient Response ³						
ΔV 50% to 100% of Max Load	3.3V			120	150	mV
Settling Time		Ts		40	60	μs
ΔV 100% to 50% of Max Load				120	150	mV
Settling Time		Ts		40	60	μs
Transient Response ³						
ΔV 50% to 100% of Max Load	2.5V			100	130	mV
Settling Time		Ts		40	60	μs
ΔV 100% to 50% of Max Load				100	130	mV
Settling Time		Ts		40	60	μs
Transient Response ³						
ΔV 50% to 100% of Max Load	1.8V			90	120	mV
Settling Time		Ts		40	60	μs
ΔV 100% to 50% of Max Load				90	120	mV
Settling Time		Ts		40	60	μs

Note: All specifications are typical at nominal input, full load at 25° C unless otherwise stated.

3. di/dt=0.1A/uS, Ta=25° C with 220uF/10V Tan cap.

BP05xRAH-02A

Output Specifications

Parameter	Module	Symbol	Min	Typical	Max	Units
Transient Response ³						
ΔV 50% to 100% of Max Load	1.5V			80	110	mV
Settling Time		Ts		40	60	μs
ΔV 100% to 50% of Max Load				80	110	mV
Settling Time		Ts		40	60	μs
Transient Response ³						
ΔV 50% to 100% of Max Load	1.2V			70	100	mV
Settling Time		Ts		40	60	μs
ΔV 100% to 50% of Max Load				70	100	mV
Settling Time		Ts		40	60	μs
Transient Response ³						
ΔV 50% to 100% of Max Load	0.9V			60	90	mV
Settling Time		Ts		40	60	μs
ΔV 100% to 50% of Max Load				60	90	mV
Settling Time		Ts		40	60	μs

Note: All specifications are typical at nominal input, full load at 25° C unless otherwise stated.
 3. di/dt=0.1A/uS, Ta=25° C with 220uF/10V Tan cap.

NON-ISOLATED DC/DC CONVERTERS

12V Input / 0.9V – 5.0V Output / 2A



BP05xRAH-02A

General Specifications

Parameter	Module	Symbol	Min	Typical	Max	Units
Efficiency ¹	5.0V	η	86	89		%
	3.3V		85	88		
	2.5V		83	86		
	1.8V		79	82		
	1.5V		75	78		
	1.2V		71	74		
	0.9V		67	70		
Switching Frequency	0.9V ~ 3.3V	Fsw	210	250	290	kHz
	5.0V		280	320	360	
Output Voltage Trim Range (Wide Trim) ²	0.9V				403	%
Output Voltage Trim Range (Narrow Trim) ²	5.0V		90		110	%
	3.3V		90		110	
	2.5V		90		110	
	1.8V		90		110	
	1.5V		90		110	
	1.2V		90		110	
	0.9V		--		110	
Weight	All			4.9		g

1. Efficiency is measured at Vin=12V, full load and Ta=25° C.
2. See graphs on pages 17-25.

Control Specifications

Parameter	Module	Symbol	Min	Typical	Max	Units
Remote On/Off ³	All	Vouten				V
Signal Low (Unit Off)	All		-0.3		1	V
Signal High (Unit On)	All		2.8		13.2	V

3. With remote on/off pin 1 open, unit on.

BP05xRAH-02A

Efficiency Data

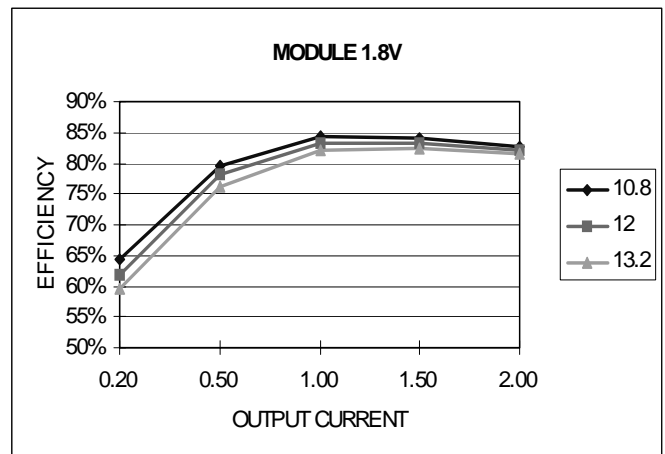
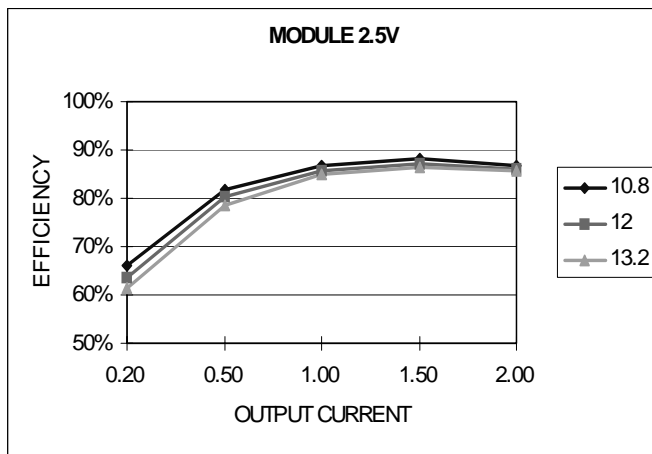
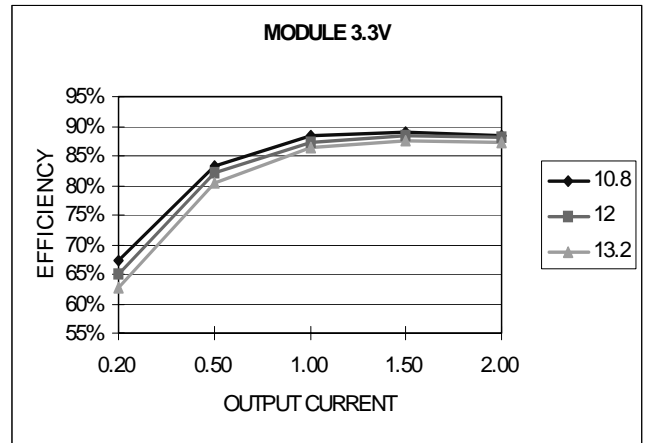
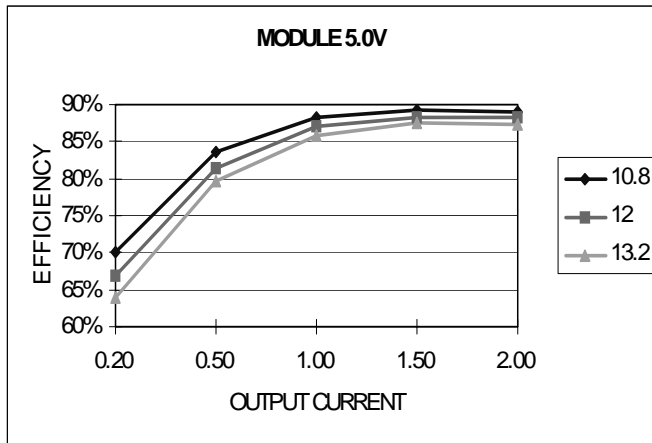

NON-ISOLATED DC/DC CONVERTERS

12V Input / 0.9V – 5.0V Output / 2A



BP05xRAH-02A

Efficiency Data

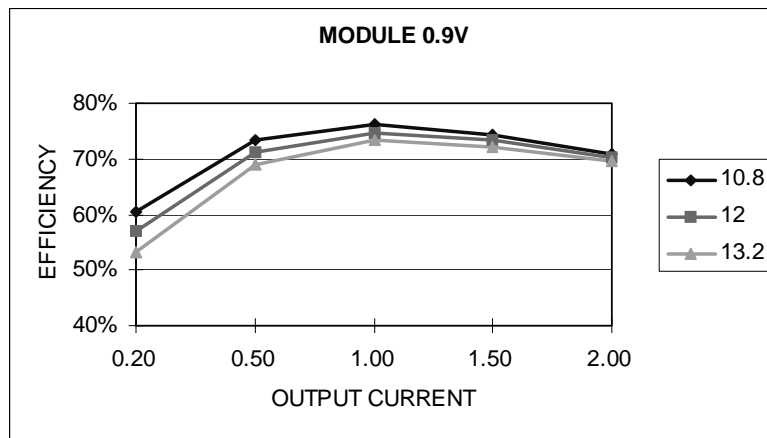
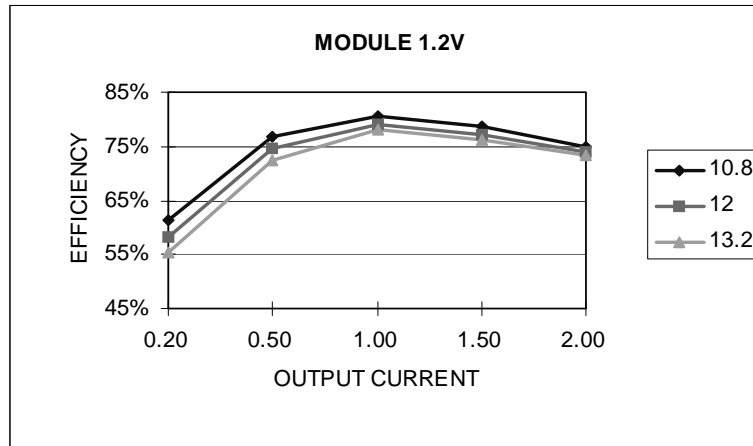
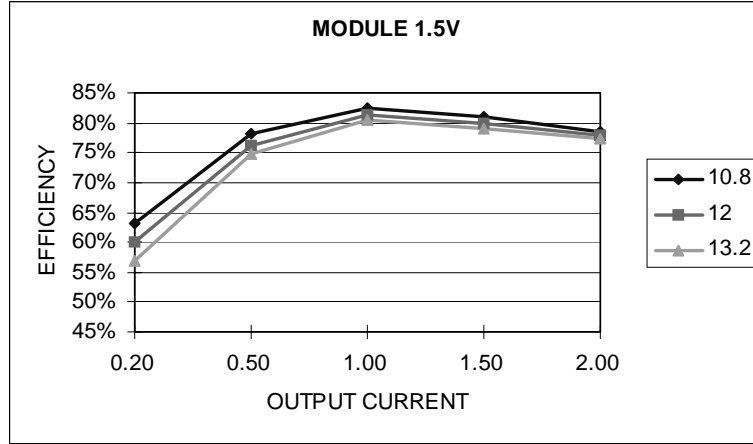

BP05xRAH-02A

Ripple and Noise

With 100µF tan cap and 1µF ceramic cap at the output.

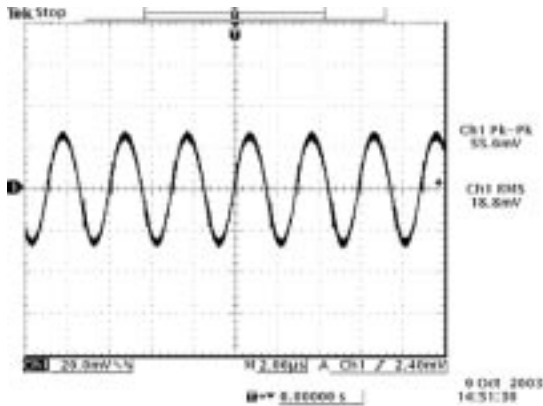

Ripple and noise at full load and 12Vdc input, 5.0Vdc output and Ta=25° C

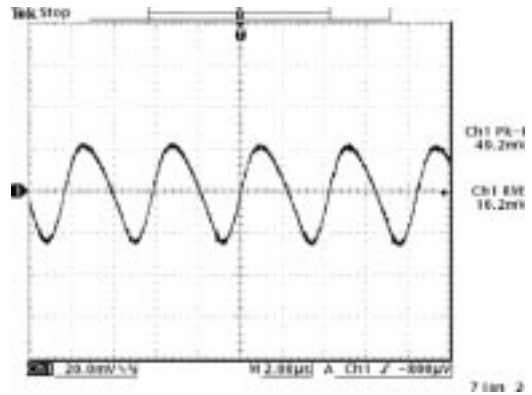

Ripple and noise at full load and 12Vdc input, 3.3Vdc output and Ta=25° C

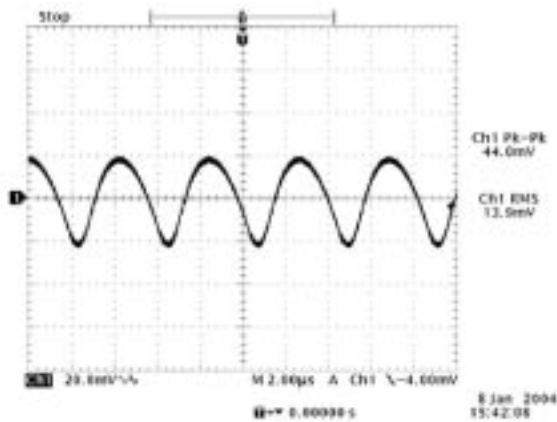

Ripple and noise at full load and 12Vdc input, 2.5Vdc output and Ta=25° C

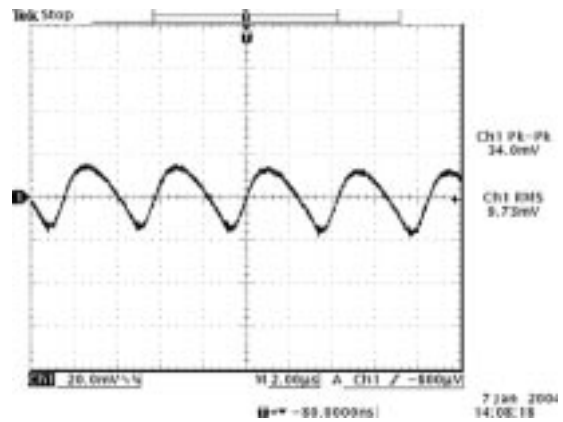

Ripple and noise at full load and 12Vdc input, 1.8Vdc output and Ta=25° C

NON-ISOLATED DC/DC CONVERTERS

12V Input / 0.9V – 5.0V Output / 2A

Ripple and Noise

With 100 μ F tan cap and 1 μ F ceramic cap at the output.

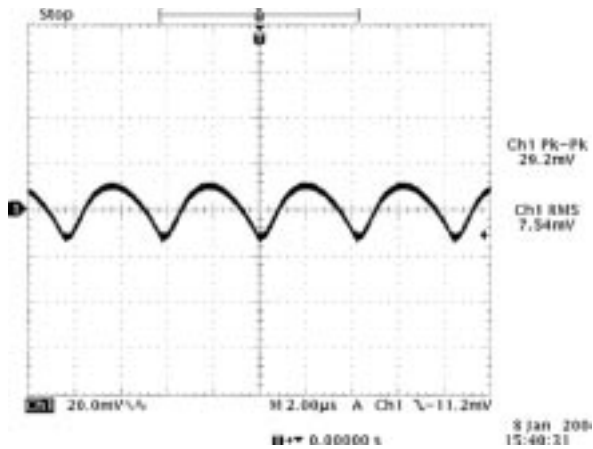

Ripple and noise at full load and 12Vdc input, 1.5Vdc output and Ta=25° C

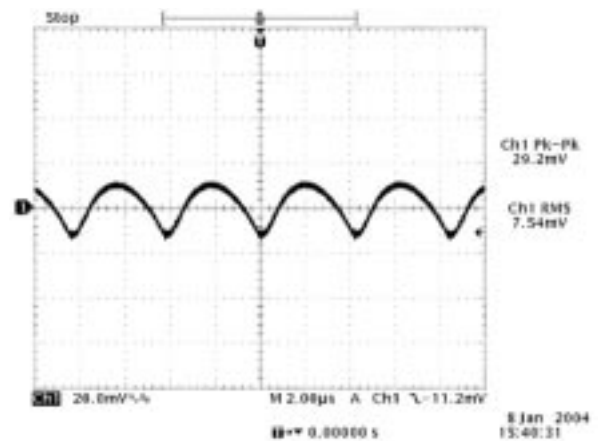

Ripple and noise at full load and 12Vdc input, 1.2Vdc output and Ta=25° C

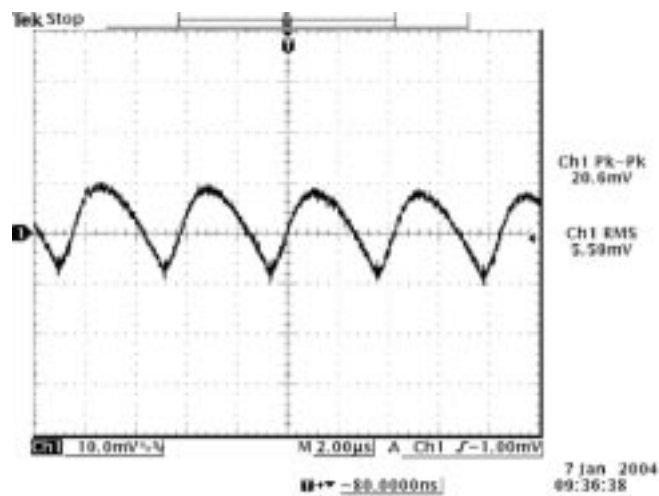

Ripple and noise at full load and 12Vdc input, 0.9Vdc output and Ta=25° C

BP05xRAH-02A

Transient Response

Transient response: $di/dt = 0.1A/\mu S$, with 220 μF Tan capacitor.

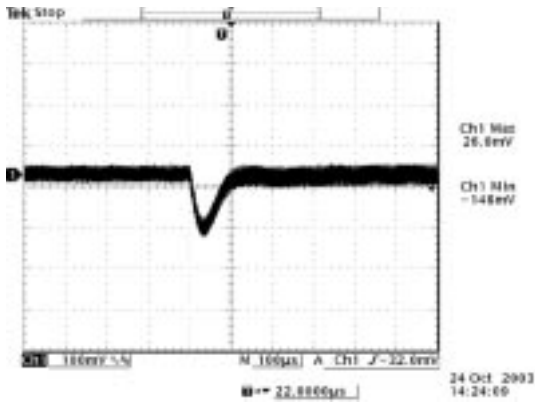

Vout=5.0V
50% to 100% load transients at 12V input and Ta=25° C

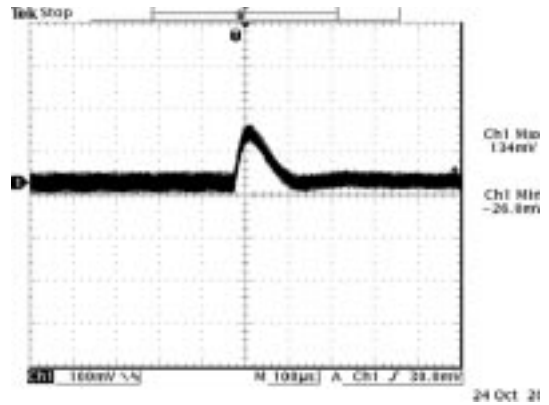

Vout=5.0V
100% to 50% load transients at 12V input and Ta=25° C

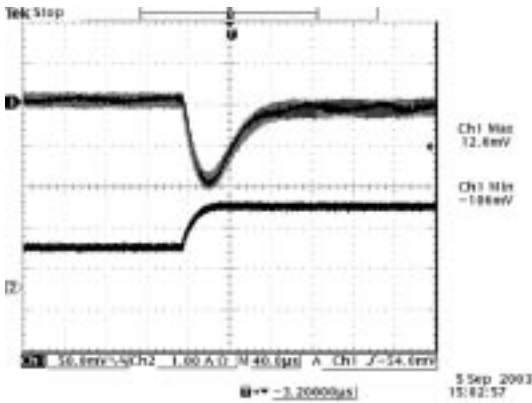

Vout=3.3V
50% to 100% load transients at 12V input and Ta=25° C

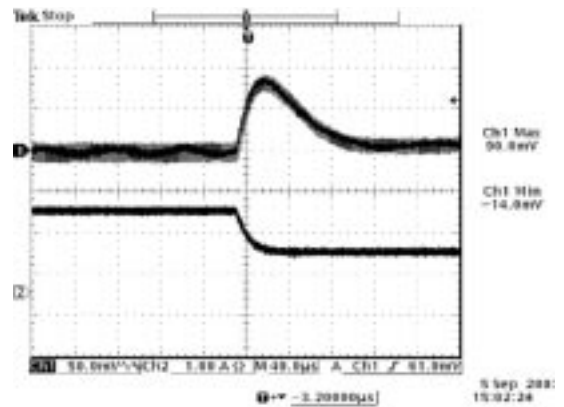

Vout=3.3V
100% to 50% load transients at 12V input and Ta=25° C

NON-ISOLATED DC/DC CONVERTERS

12V Input / 0.9V – 5.0V Output / 2A



BP05xRAH-02A

Transient Response

Transient response: $di/dt = 0.1A/\mu S$, with 220 μF Tan capacitor..

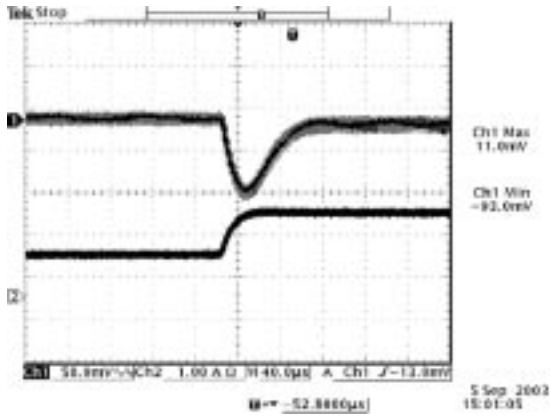

Vout=2.5V
50% to 100% load transients at 12V input and Ta=25° C

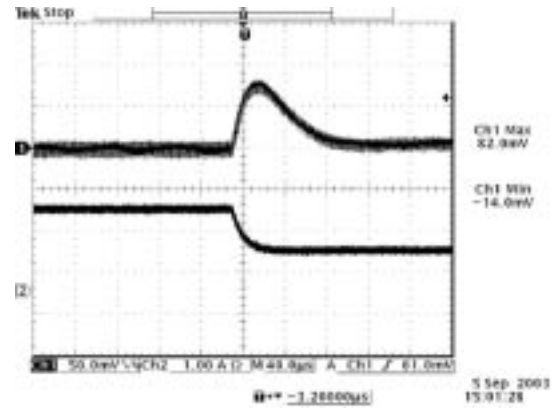

Vout=2.5V
100% to 50% load transients at 12V input and Ta=25° C

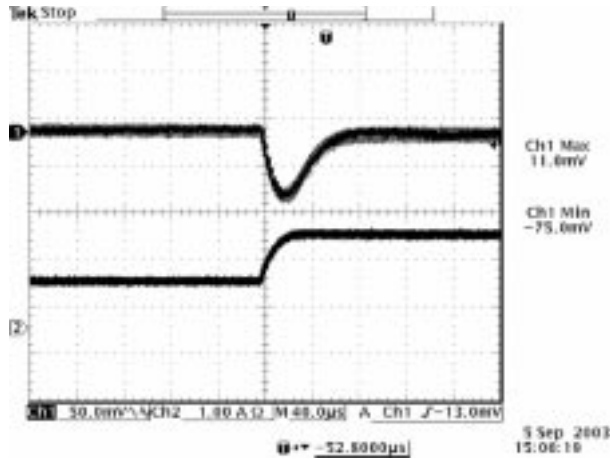

Vout=1.8V
50% to 100% load transients at 12V input and Ta=25° C

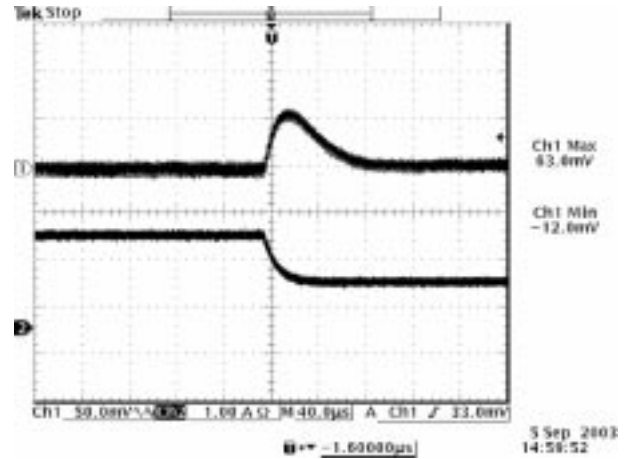

Vout=1.8V
100% to 50% load transients at 12V input and Ta=25° C

BP05xRAH-02A

Transient Response

Transient response: $di/dt = 0.1A/\mu S$, with 220 μF Tan capacitor..

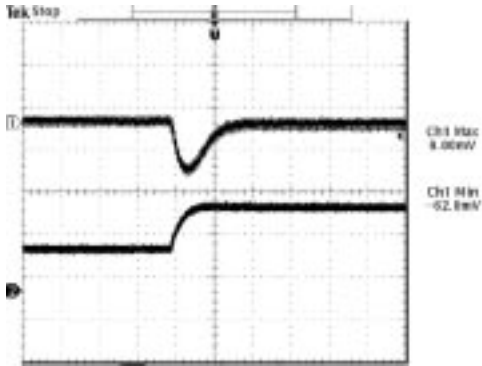

Vout=1.5V
50% to 100% load transients at 12V input and Ta=25° C

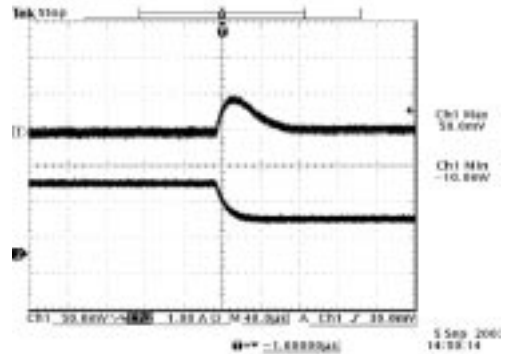

Vout=1.5V
100% to 50% load transients at 12V input and Ta=25° C

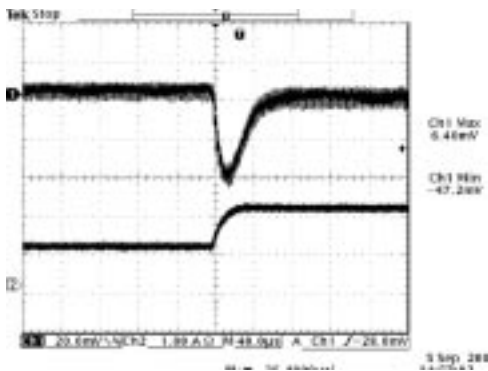

Vout=1.2V
50% to 100% load transients at 12V input and Ta=25° C

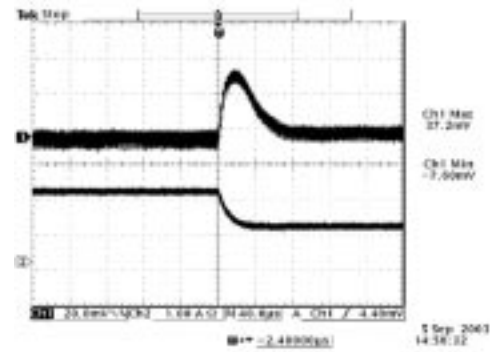

Vout=1.2V
100% to 50% load transients at 12V input and Ta=25° C

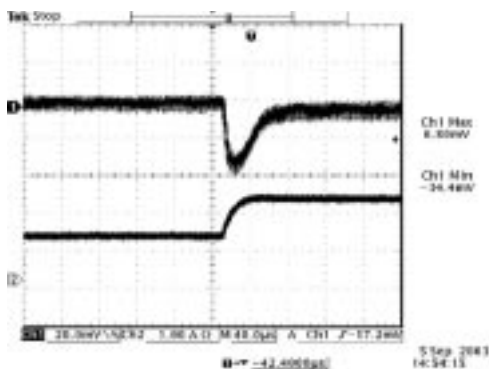

Vout=0.9V
50% to 100% load transients at 12V input and Ta=25° C

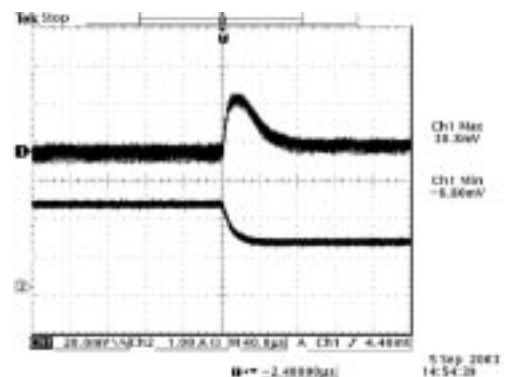

Vout=0.9V
100% to 50% load transients at 12V input and Ta=25° C

NON-ISOLATED DC/DC CONVERTERS

12V Input / 0.9V – 5.0V Output / 2A



BP05xRAH-02A

Thermal Considerations

Vin = 12V

xRAH-02A1Ax
0.9 ~ 3.3V

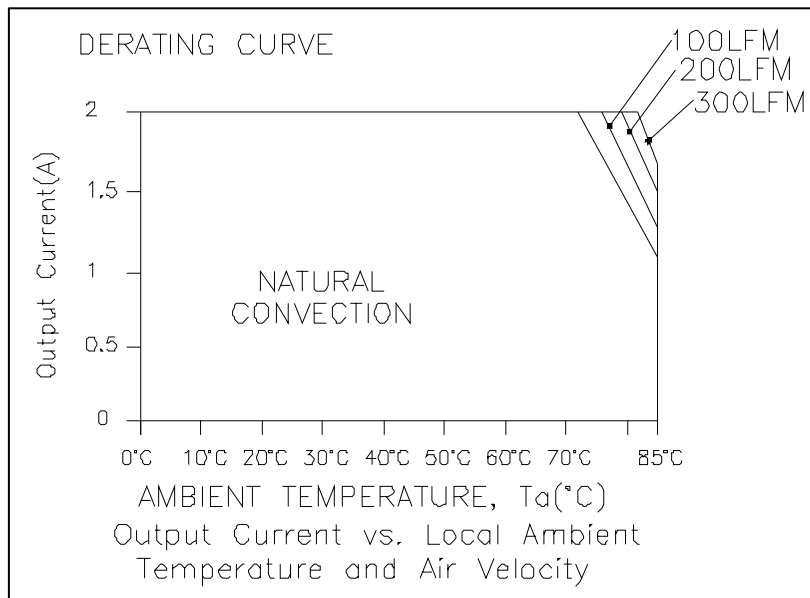

xRAH-02A50x

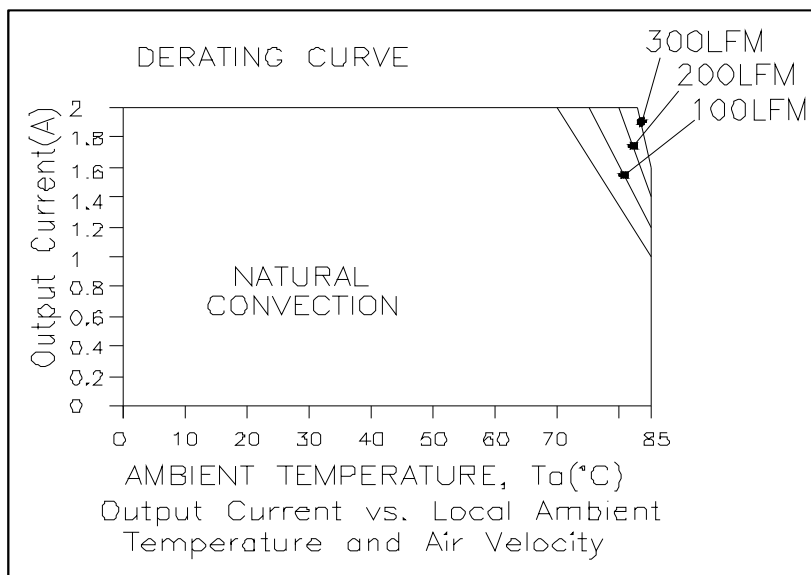

BP05xRAH-02A

Output Voltage Set-Point Adjustment

xRAH-02A1Ax Trim Resistor Calculation

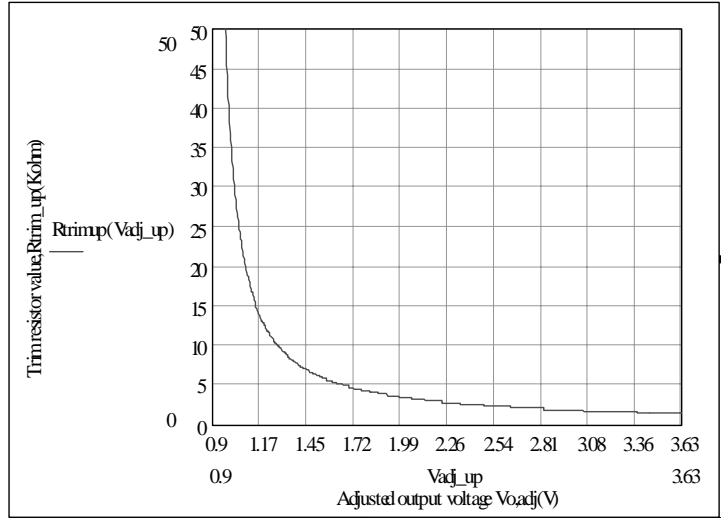
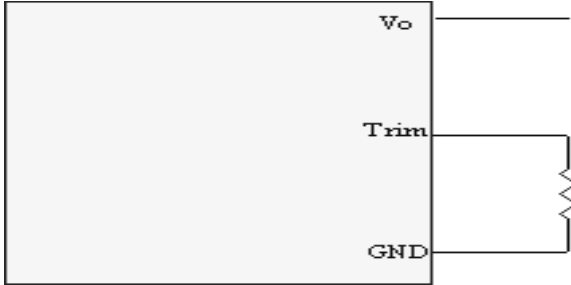

$$R_{trim\ up} = \left(\frac{3.712}{V_{o, adj} - V_o} \right) \text{ Kohm}$$

Note: Output voltage $V_o=0.90$ 3V when trim pin is not connected.

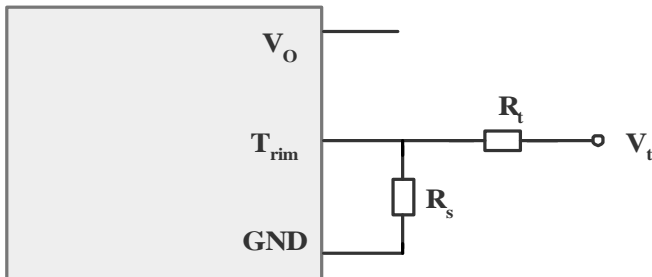

$$R_t \text{ (Kohm)} = \left(\frac{R_s (4.64V_t - 3.712)}{3.712 - R_s(V_{out} - 0.903)} \right) \text{ Kohm}$$

Note: Output voltage $V_o=0.90$ 3V when trim pin is not connected.

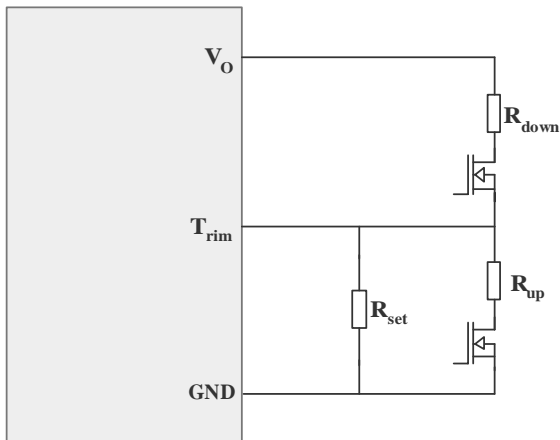

$$R_{set} = \left(\frac{3.712}{V_{out} - 0.903} \right) \text{ Kohm}$$

V_{out} is desired output voltage.

$$R_{up} = \left(\frac{3.712 R_{set}}{R_{set} \cdot V_{m\ up} - 0.903 R_{set} - 3.712} \right) \text{ Kohm}$$

Margin up value after output voltage is set with R_{set}

$$R_{down} = \left(\frac{4.64 R_{set} \cdot V_{m\ down} - 3.712 R_{set}}{0.903 R_{set} + 3.712 - R_{set} \cdot V_{m\ down}} \right) \text{ Kohm}$$

Margin down value after output voltage is set with R_{set}

$V_{m\ down} \geq 90\% V_{out}$

Note: Output voltage $V_o=0.90$ 3V when trim pin is not connected.

NON-ISOLATED DC/DC CONVERTERS

12V Input / 0.9V – 5.0V Output / 2A



BP05xRAH-02A

Output Voltage Set-Point Adjustment

Trim Up Test Circuit

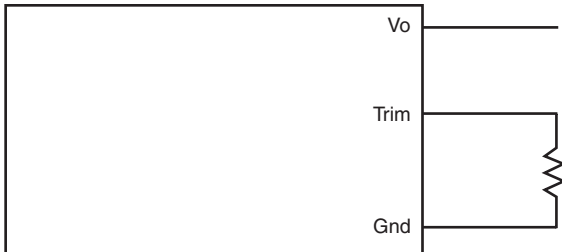

xRAH-02A090 Trim Resistor Calculation

$$R_{trim_up} = \frac{3.712}{V_{o,adj} - V_o} \text{ Kohm}$$

where,

V_o is the nominal output voltage setpoint when trim pin is open, $V_o=0.903V$

$V_{o,adj}$ is the adjusted output voltage.

$R_{trim-up}$ is the resistance required between TRIM and GND.

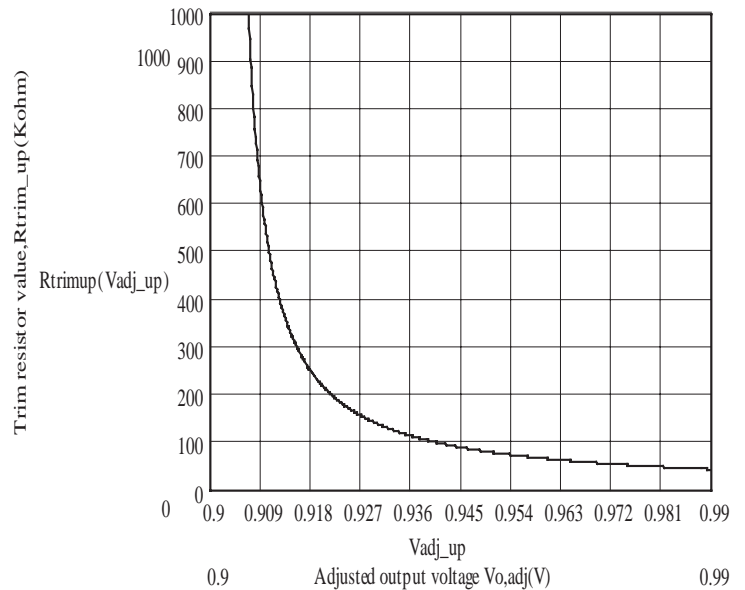

BP05xRAH-02A

Output Voltage Set-Point Adjustment

Trim Down Test Circuit

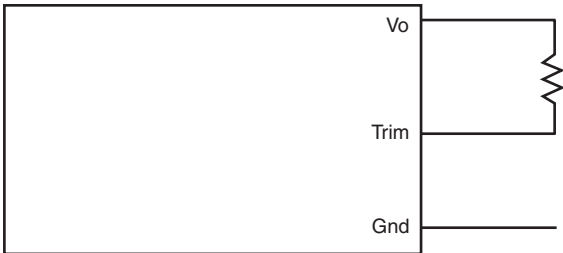

Trim Up Test Circuit

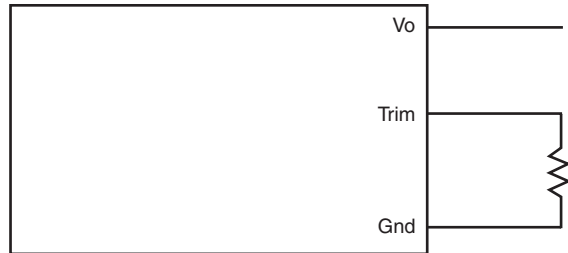

xRAH-02A120 Trim Resistor Calculation

$$R_{trim_down} = \frac{1.87}{V_o - V_{o,adj}} - 4.64 \text{ Kohm}$$

where,

V_o is the nominal output voltage setpoint when trim pin is open, $V_o=1.203V$
 $V_{o,adj}$ is the adjusted output voltage.
 $R_{trim-down}$ is the resistance required between TRIM and V_o .

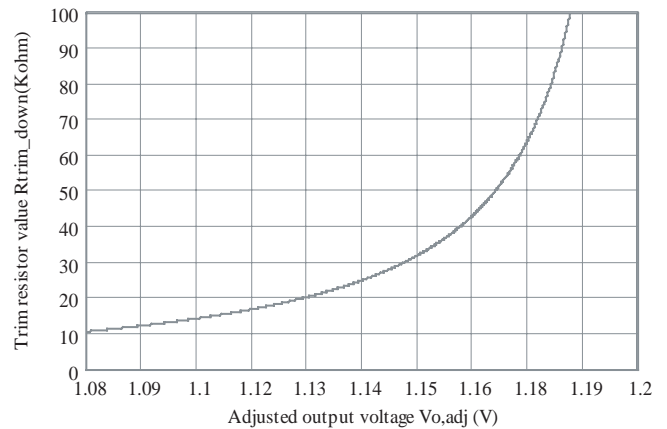

$$R_{trim_up} = \frac{3.712}{V_{o,adj} - V_o} \text{ Kohm}$$

where,

V_o is the nominal output voltage setpoint when trim pin is open, $V_o=1.203V$
 $V_{o,adj}$ is the adjusted output voltage.
 $R_{trim-up}$ is the resistance required between TRIM and GND.

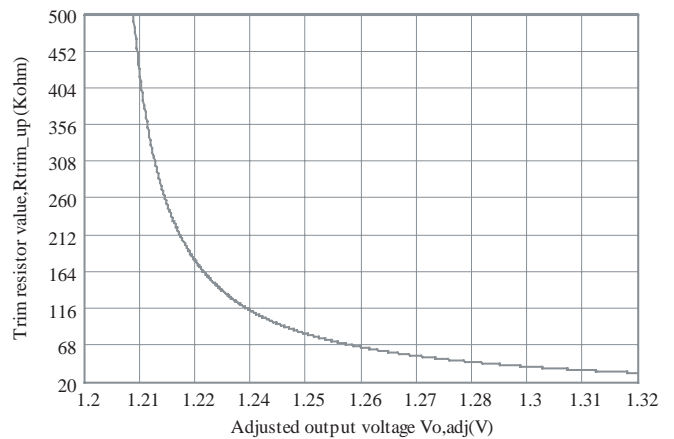

NON-ISOLATED DC/DC CONVERTERS

12V Input / 0.9V – 5.0V Output / 2A



BP05xRAH-02A

Output Voltage Set-Point Adjustment

xRAH-02A150 Trim Resistor Calculation

$$R_{trim_down} = \frac{3.2633}{V_o - V_{o,adj}} - 4.64 \text{ Kohm}$$

where,

V_o is the nominal output voltage setpoint when trim pin is open, $V_o=1.503V$

$V_{o,adj}$ is the adjusted output voltage.

$R_{trim-down}$ is the resistance required between TRIM and V_o .

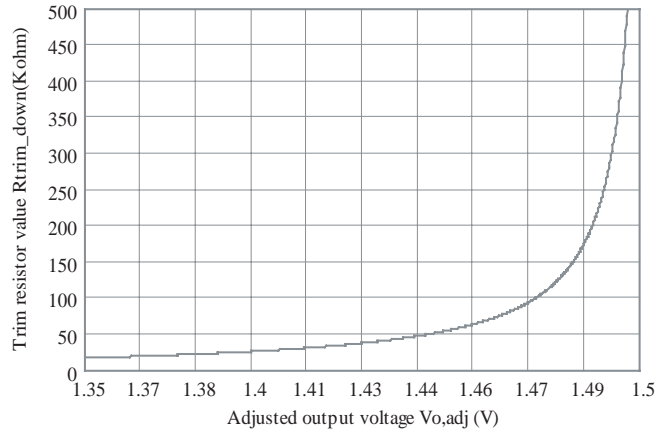

$$R_{trim_up} = \frac{3.712}{V_{o,adj} - V_o} \text{ Kohm}$$

where,

V_o is the nominal output voltage setpoint when trim pin is open, $V_o=1.503V$

$V_{o,adj}$ is the adjusted output voltage.

$R_{trim-up}$ is the resistance required between TRIM and GND.

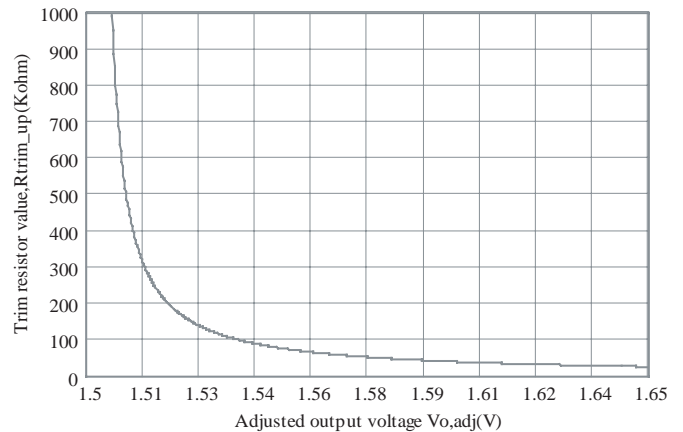

BP05xRAH-02A

Output Voltage Set-Point Adjustment

xRAH-02A180 Trim Resistor Calculation

$$R_{trim_down} = \frac{4.6538}{V_o - V_{o,adj}} - 4.64 \text{ Kohm}$$

where,

V_o is the nominal output voltage setpoint when trim pin is open, $V_o=1.803V$

$V_{o,adj}$ is the adjusted output voltage.

$R_{trim-down}$ is the resistance required between TRIM and V_o .

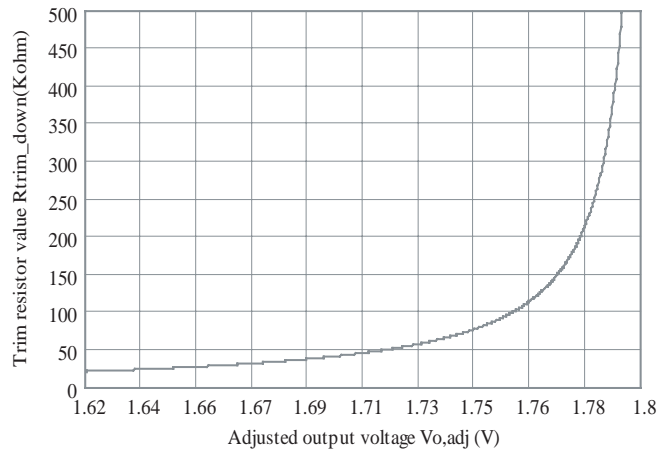

$$R_{trim_up} = \frac{3.712}{V_{o,adj} - V_o} \text{ Kohm}$$

where,

V_o is the nominal output voltage setpoint when trim pin is open, $V_o=1.803V$

$V_{o,adj}$ is the adjusted output voltage.

$R_{trim-up}$ is the resistance required between TRIM and GND.

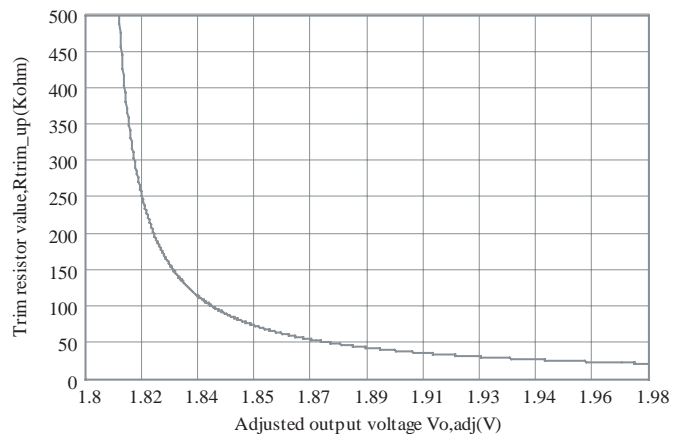

NON-ISOLATED DC/DC CONVERTERS

12V Input / 0.9V – 5.0V Output / 2A



BP05xRAH-02A

Output Voltage Set-Point Adjustment

xRAH-02A250 Trim Resistor Calculation

$$R_{trim_down} = \frac{7.9117}{V_o - V_{o,adj}} - 4.64 \text{ Kohm}$$

where,

V_o is the nominal output voltage setpoint when trim pin is open, $V_o=2.503V$

$V_{o,adj}$ is the adjusted output voltage.

$R_{trim-down}$ is the resistance required between TRIM and V_o .

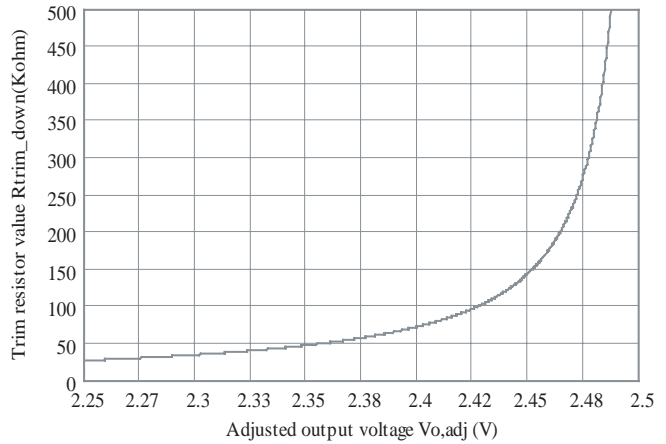

$$R_{trim_up} = \frac{3.712}{V_{o,adj} - V_o} \text{ Kohm}$$

where,

V_o is the nominal output voltage setpoint when trim pin is open, $V_o=2.503V$

$V_{o,adj}$ is the adjusted output voltage.

$R_{trim-up}$ is the resistance required between TRIM and GND.

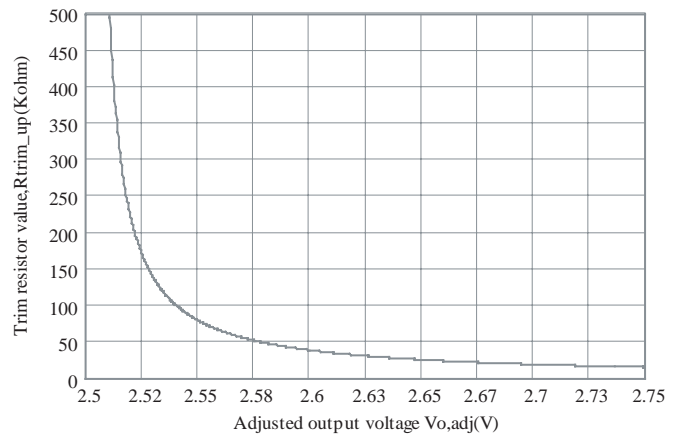

BP05xRAH-02A

Output Voltage Set-Point Adjustment

xRAH-02A330 Trim Resistor Calculation

$$R_{trim_down} = \frac{11.614}{V_o - V_{o,adj}} - 4.64 \text{ Kohm}$$

where,

V_o is the nominal output voltage setpoint when trim pin is open, $V_o=3.303V$

$V_{o,adj}$ is the adjusted output voltage.

$R_{trim-down}$ is the resistance required between TRIM and V_o .

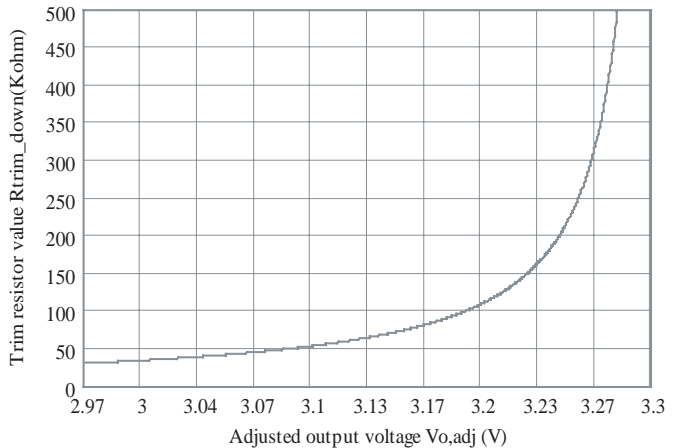

$$R_{trim_up} = \frac{3.712}{V_{o,adj} - V_o} \text{ Kohm}$$

where,

V_o is the nominal output voltage setpoint when trim pin is open, $V_o=3.303V$

$V_{o,adj}$ is the adjusted output voltage.

$R_{trim-up}$ is the resistance required between TRIM and GND.

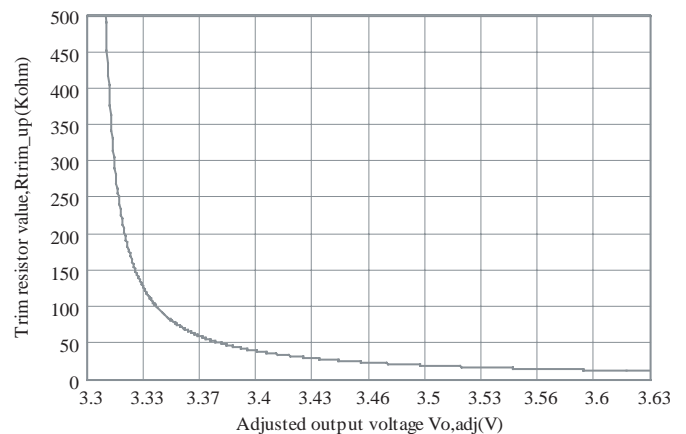

NON-ISOLATED DC/DC CONVERTERS

12V Input / 0.9V – 5.0V Output / 2A



BP05xRAH-02A

Output Voltage Set-Point Adjustment

xRAH-02A50x Trim Resistor Calculation

$$R_{trim_down} = \frac{26.02}{V_o - V_{o,adj}} - 13.69 \text{ Kohm}$$

where,

V_o is the nominal output voltage setpoint when trim pin is open, $V_o=5.003V$

$V_{o,adj}$ is the adjusted output voltage.

$R_{trim-down}$ is the resistance required between TRIM and V_o .

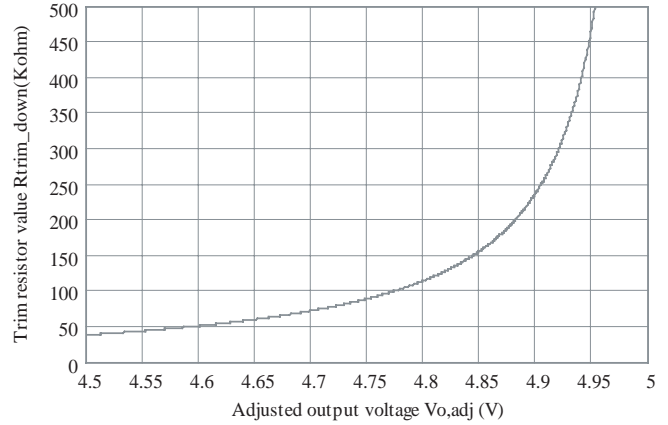

$$R_{trim_up} = \frac{4.952}{V_{o,adj} - V_o} - 7.5 \text{ Kohm}$$

where,

V_o is the nominal output voltage setpoint when trim pin is open, $V_o=5.003V$

$V_{o,adj}$ is the adjusted output voltage.

$R_{trim-up}$ is the resistance required between TRIM and GND.

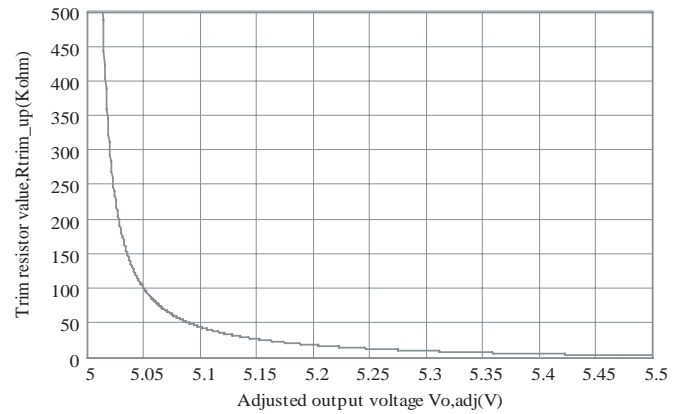

BP05xRAH-02A

Mechanical

SRAH-02A

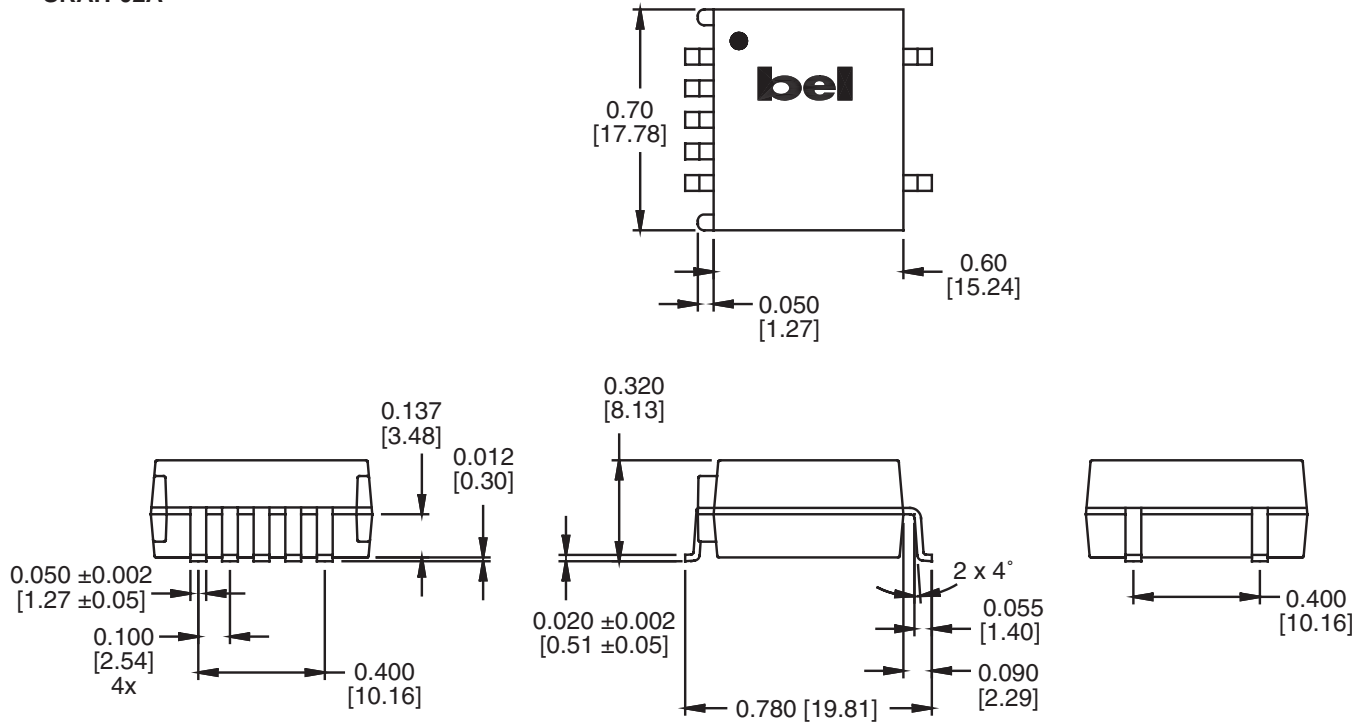

Dimensions are in inches [millimeters].
Standard dimension tolerance is ±0.005 [0.13] unless otherwise noted.

Pin	Function
1	Remote On/Off
2	+Vin
3	Ground
4	+Vo
5	Trim
6	No Connection
7	No Connection

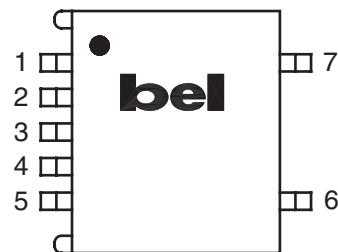

NON-ISOLATED DC/DC CONVERTERS

12V Input / 0.9V – 5.0V Output / 2A



BP05xRAH-02A

Mechanical

VRAH-02A

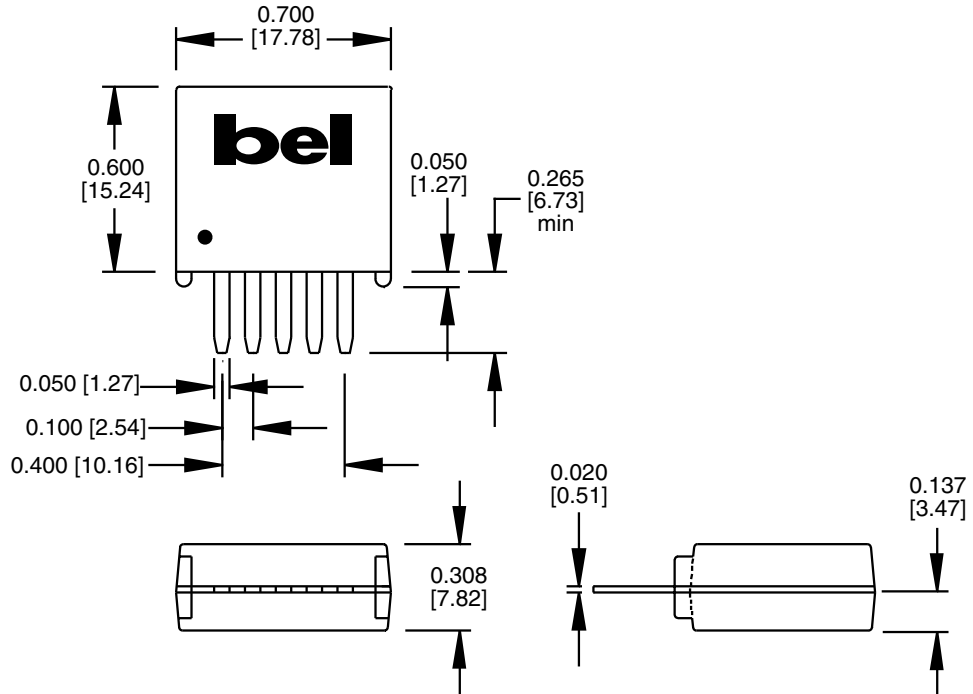

Dimensions are in inches [millimeters].
 Standard dimension tolerance is ± 0.005 [0.13] unless otherwise noted.

Pin	Function
1	Remote On/Off
2	+Vin
3	Ground
4	+Vo
5	Trim

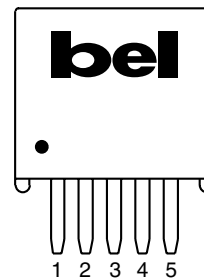

RoHS Compliance

Complies with the European Directive 2002/95/EC, calling for the elimination of lead and other hazardous substances from electronic products. These parts are not however compatible with the higher temperatures associated with lead free solder processes and must be soldered using a reflow profile with a peak temperature of no more than 240°C.



©2005 Bel Fuse Inc. Specifications subject to change without notice. 03.05

CORPORATE

Bel Fuse Inc.
 206 Van Vorst Street
 Jersey City, NJ 07302
 Tel 201-432-0463
 Fax 201-432-9542
 www.belfuse.com

FAR EAST

Bel Fuse Ltd.
 8F / 8 Luk Hop Street
 San Po Kong
 Kowloon, Hong Kong
 Tel 852-2328-5515
 Fax 852-2352-3706
 www.belfuse.com

EUROPE

Bel Fuse Europe Ltd.
 Preston Technology Management Centre
 Marsh Lane, Suite G7, Preston
 Lancashire, PR1 8UD, U.K.
 Tel 44-1772-556601
 Fax 44-1772-888366
 www.belfuse.com