

# DeviceNet Micro-Style Connectors

## CM02 Series



Conforming Standard  
DeviceNet

Waterproof  
IP 67

Lock Type  
Threaded Coupling



### ◆ OUTLINE

The CM02 series is a Micro-style connector for use in a DeviceNet communication network.

These products provide connections between simple industrial devices such as sensor, actuators and higher-level devices such as controllers.

This connector system is also recommended for CCLink network and can be used in harsh environmental conditions, having IP67 rated for protection against moisture, oil and dust.

### ◆ FEATURES

- Crimp termination for the cable mount plugs and jacks
- Receptacle : Soldering
- Protection from wiring errors by color-coding the contact holder with red, white, blue and black
- Available style are cable mount plug with socket contacts, cable mount jack with pin contacts, T tap, panel mount receptacle with pin contacts, panel mount plug receptacle with socket contacts, terminating resistor and dust cap

### ◆ SPECIFICATIONS

Rated Current	3A/contact
Rated Voltage	24V DC
Dielectric Withstanding Voltage	500V AC(r.m.s) for 1 minute
Insulation Resistance	1000M Ω min. at 250V DC
Operating Temperature Range	- 40°C to +85°C
Waterproof	IP67 when mated
No. of Contacts	5

### Physical Configuration of Cables For Example

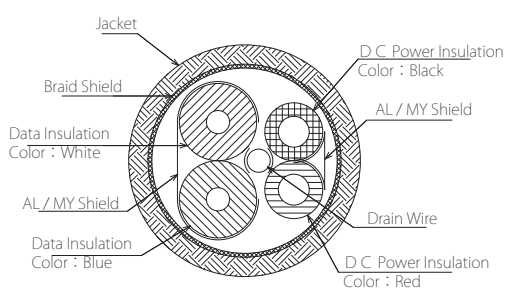

DeviceNet Thick Cable

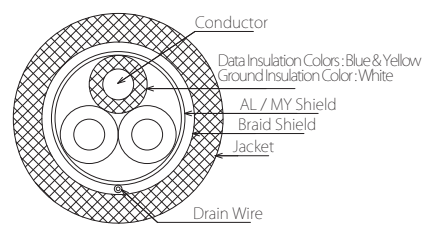

CC-Link Cable

© Specifications and/or dimensions in this catalog are subject to change without notice.  
Your checking the latest specifications with our drawings would be highly appreciated.



## MATERIAL/FINISH

Item	Plug (With Socket Contacts)	Jack (With Pin Contacts)	Resistor (With Pin or Socket Contacts)
Insulator	Plastic(UL94V-0)/Black	Plastic(UL94V-0)/Black	Plastic(UL94V-0)/Black
Contact	Copper Alloy/Gold Plating	Copper Alloy/Gold Plating	Copper Alloy/Gold Plating
Coupling Ring	Copper Alloy/Nickel Plating	Copper Alloy/Gold Plating	Copper Alloy/Gold Plating
Backshell Nut	Aluminum Alloy/Black	Aluminum Alloy/Black	Aluminum Alloy/Black
Contact Holder	Plastic(UL94V-0)/Black	Plastic(UL94V-0)/Black	Plastic(UL94V-0)/Black
Backshell	Plastic(UL94V-0)/Black	Plastic(UL94V-0)/Black	Plastic(UL94V-0)/Black
Clamp Nut	Plastic(UL94V-0)/Black	Plastic(UL94V-0)/Black	
O-Ring	Synthetic Rubber/Black	Synthetic Rubber/Black	Synthetic Rubber/Black
Gasket	Synthetic Rubber/Black		Synthetic Rubber/Black for Socket
Bushing	Synthetic Rubber/Black	Synthetic Rubber/Black	

Item	"T" Tap	Receptacle (With Pin Contacts)	Plug Receptacle (With Socket Contacts)
Insulator	Plastic(UL94V-0)/Black	Plastic(UL94V-0)/Black	Plastic(UL94V-0)/Black
Contact	Copper Alloy/Gold Plating	Copper Alloy/Gold Plating	Copper Alloy/Gold Plating
Coupling Ring	Zinc Alloy/Nickel Plating		
Shell		Copper Alloy/Nickel Plating	Zinc Alloy/Nickel Plating
Nut Washer		Copper Alloy/Nickel Plating	Copper Alloy/Nickel Plating
Gasket(Mating Side)	Synthetic Rubber/Black		Synthetic Rubber/Black
Gasket(Mounting Side)		Synthetic Rubber/Black	Synthetic Rubber/Black
Overmolding Resin	Plastic(UL94V-0)/Black		

## CRIMP TOOL

### • For DeviceNet Plug and Jack

Highly reliable crimp termination can be made for the straight plug and the straight jack. Two kinds of crimp tools are needed since a connector has a straight contact and angle contacts of which style are different. However the locator can be removed and you can use one hand tool for termination if you have two locators each for the straight contact and the angle contacts.



Item	Conductor Size	
	AWG 22 - AWG 24	AWG 18 - AWG 20
A set of crimp tool for straight contacts	357J-19811	357J-17917
Contents	Hand Tool	357J-12610
	Locator	357J-18918
	Inspection Gauge 2	357J-19779-2
A set of crimp tool for angle contacts	357J-19812	357J-17898
Contents	Hand Tool	357J-12610
	Locator	357J-17899
	Inspection Gauge 1	357J-19779-1
	Inspection Gauge 2	357J-19779-2

### • For CC-Link Plug and Jack

The connectors for CC-Link network will have four (4) angle contacts and the style of contact is only one. It is feasible for you to terminate the cable to the contacts by one kind of the crimp tool for angle contacts.

Item	Conductor Size
	AWG 18-AWG 20
A set of crimp tool for angle contacts	357J-21598
Contents	Hand Tool
	Locator
	Inspection Gauge 2

## ◆ CONFIGURATION OF CONTACTS

Straight Pin Contact

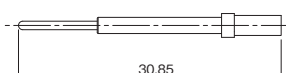

Angle Pin Contact

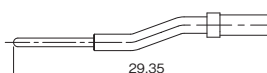

Straight Socket Contact

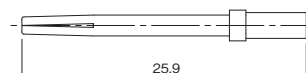

Angle Socket Contact



© Specifications and/or dimensions in this catalog are subject to change without notice.  
Your checking the latest specifications with our drawings would be highly appreciated.

## ▶ Straight Plug With Socket Contacts

### • DeviceNet Plug

A set of plug consists of 1 body, 1 straight contact and 4 angle contacts

P/N		Applicable Cable	
		Conductor Size	Outside Dia.
A set of plug : CM02A-8DP5S-D(02)		AWG22 - AWG24	$\phi$ 6.5mm - $\phi$ 7.2mm
Contents	Body : CM02A-8DP5S-D(02)-0		
	Straight Contact : CM02A-SSC-2224		
	Angle Contact : CM02A-ASC-2224		
A set of plug : CM02A-8DP5S-D(04)		AWG22 - AWG24	$\phi$ 8.8mm - $\phi$ 9.8mm
Contents	Body : CM02A-8DP5S-D(04)-0		
	Straight Contact : CM02A-SSC-2224		
	Angle Contact : CM02A-ASC-2224		
A set of plug : CM02A-8DP5S-D(02)(D9)		AWG18 - AWG20	$\phi$ 6.5mm - $\phi$ 7.2mm
Contents	Body : CM02A-8DP5S(02)(D9)-0		
	Straight Contact : CM02A-SSC-1820		
	Angle Contact : CM02A-ASC-1820		
A set of plug : CM02A-8DP5S-D		AWG18 - AWG20	$\phi$ 8.2mm - $\phi$ 8.9mm
Contents	Body : CM02A-8DP5S-D-0		
	Straight Contact : CM02A-SSC-1820		
	Angle Contact : CM02A-ASC-1820		
A set of plug : CM02A-8DP5S-D(01)		AWG18 - AWG20	$\phi$ 9.4mm - $\phi$ 9.9mm
Contents	Body : CM02A-8DP5S-D(01)-0		
	Straight Contact : CM02A-SSC-1820		
	Angle Contact : CM02A-ASC-1820		

A soldering style is also available. **P/N : CM02A-8DP5S-D(02)(D4)**

Applicable Cable : AWG16 max. conductor size  $\phi$  6.5mm -  $\phi$  7.2mm outside dia.

### • CC-Link Plug

A set of plug consists of 1 body and 4 angle contacts

P/N		Applicable Cable	
		Conductor Size	Outside Dia.
A set of plug : CM02A-8DP5S-D(03)		AWG18 - AWG20	$\phi$ 7.2mm - $\phi$ 7.9mm
Contents	Body : CM02A-8DP5S-D(03)-0		
	Angle Contact : CM02A-ASC-1820		

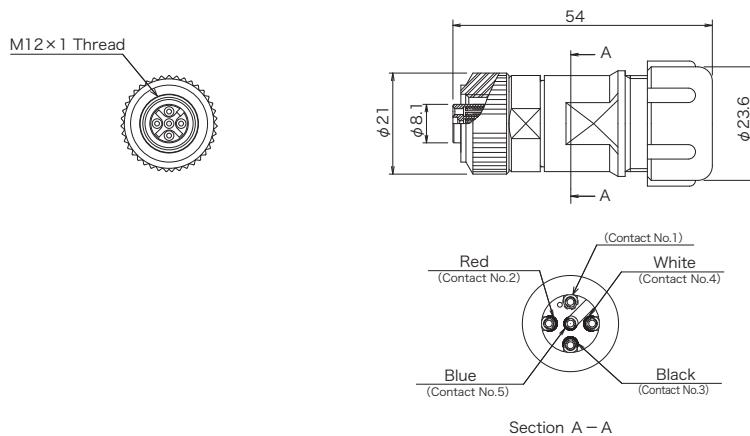

## ▶ Straight Jack With Pin Contacts

### • DeviceNet Jack

A set of Jack consists of 1 body, 1 straight contact and 4 angle contacts

P/N		Applicable Cable	
		Conductor Size	Outside Dia.
A set of Jack : CM02A-8DJ5P-D(02)		AWG22 - AWG24	φ 6.5mm - φ 7.2mm
Contents	Body : CM02A-8DJ5P-D(02)-0		
	Straight Contact : CM02A-SPC-2224		
	Angle Contact : CM02A-APC-2224		
A set of Jack : CM02A-8DJ5P-D(04)		AWG22 - AWG24	φ 8.8mm - φ 9.8mm
Contents	Body : CM02A-8DJ5P-D(04)-0		
	Straight Contact : CM02A-SPC-2224		
	Angle Contact : CM02A-APC-2224		
A set of Jack : CM02A-8DJ5P-D(02)(D9)		AWG18 - AWG20	φ 6.5mm - φ 7.2mm
Contents	Body : CM02A-8DJ5P-D(02)(D9)-0		
	Straight Contact : CM02A-SPC-1820		
	Angle Contact : CM02A-APC-1820		
A set of Jack : CM02A-8DJ5P-D		AWG18 - AWG20	φ 8.2mm - φ 8.9mm
Contents	Body : CM02A-8DJ5P-D-0		
	Straight Contact : CM02A-SPC-1820		
	Angle Contact : CM02A-APC-1820		
A set of Jack : CM02A-8DJ5P-D(01)		AWG18 - AWG20	φ 9.4mm - φ 9.9mm
Contents	Body : CM02A-8DJ5P-D(01)-0		
	Straight Contact : CM02A-SPC-1820		
	Angle Contact : CM02A-APC-1820		

A soldering style is also available. **P/N : CM02A-8DJ5P-D(02)(D4)**

Applicable Cable : AWG16 max. conductor size. φ 6.5mm - φ 7.2mm outside dia.

### • CC-Link Jack

A set of Jack consists of 1 body and 4 angle contacts

P/N		Applicable Cable	
		Conductor Size	Outside Dia.
A set of plug : CM02A-8DJ5P-D(03)		AWG 18 - AWG 20	φ 7.2mm - φ 7.9mm
Contents	Body : CM02A-8DJ5P-D(03)-0		
	Angle Contact : CM02A-APC-1820		

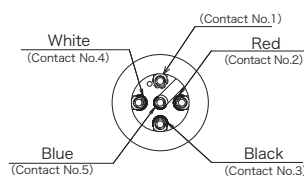
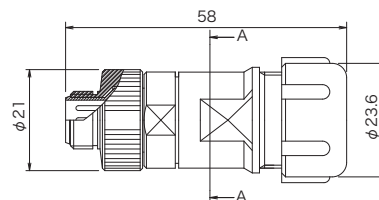
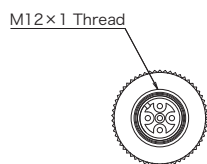

Section A - A

## ▶ “ T ” Tap

P/N : CM02-8D2TA5-CF

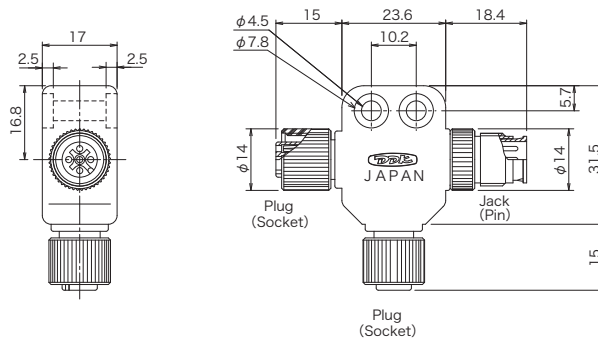

## ▶ Terminating Resistor With Pin Contacts

- Terminated between No. 4 and No. 5 with resistor, 121 ohm, 1/4 watt.

P/N : CM02B-8DER5P

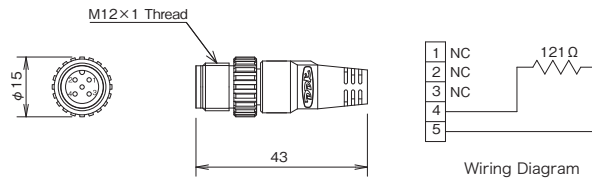

## ▶ Terminating Resistor With Socket Contacts

- Terminated between No. 4 and No. 5 with resistor, 121 ohm, 1/4 watt.

P/N : CM02B-8DER5S

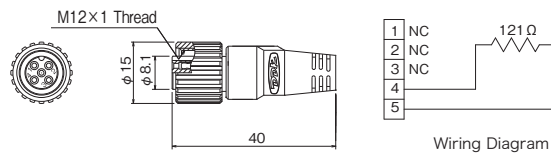

## ▶ Receptacle with Plastic Shell and Pin Contacts, Type 1

P/N : CM02-8DR5P-CF

- P C B Contacts
- Rear-mount configuration
- Applicable wire size : AWG22 max.

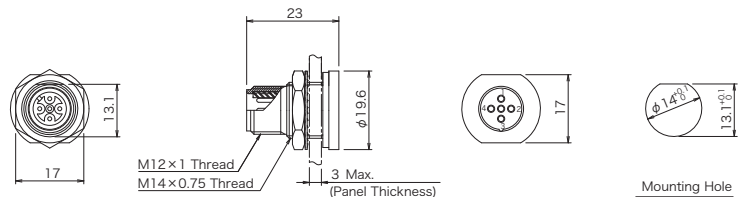

## ▶ Receptacle with Plastic Shell and Pin Contacts, Type 2

P/N : CM02-8DR5P-CF(D5)

- P C B Contacts
- Rear-mount configuration
- Applicable wire size : AWG22 max.

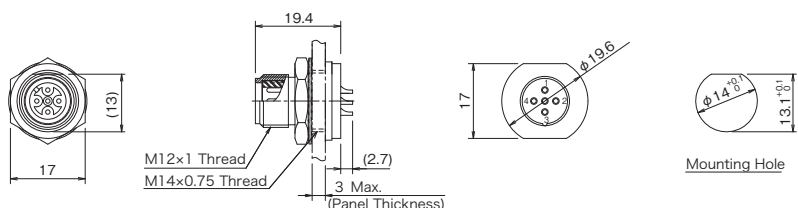

© Specifications and/or dimensions in this catalog are subject to change without notice.  
Your checking the latest specifications with our drawings would be highly appreciated.

<http://www.ddknet.co.jp>

