

修订 REV	标记 MARK	修改摘要 REVISION DESCRIPTION	签名 SIGNATURE	日期 DATE
A0		NEW DWG		2013-07-05

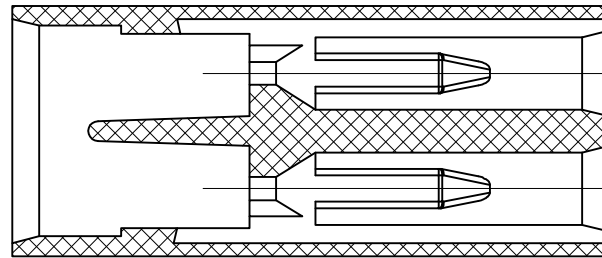

B-B

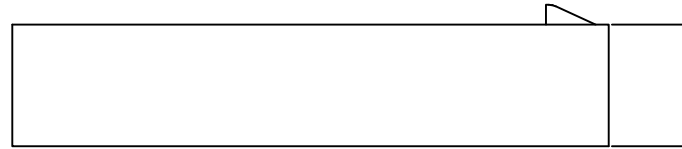
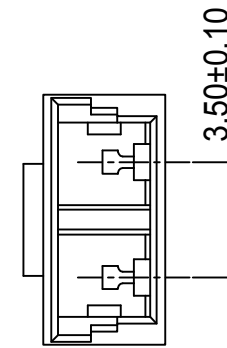
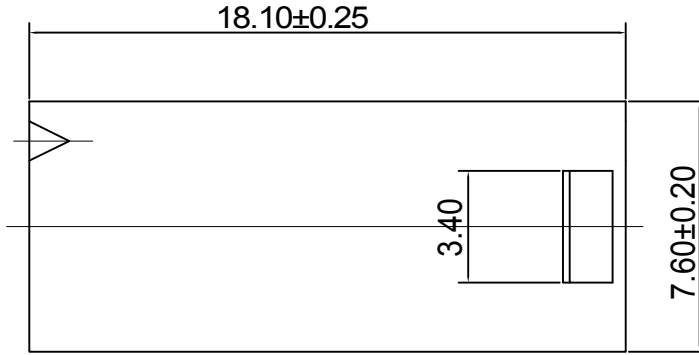
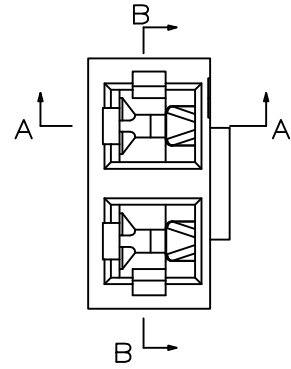
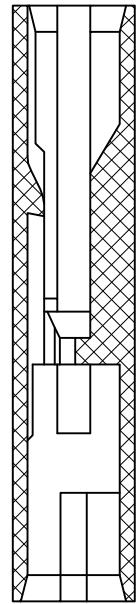

A-A

材质: PA66 UL94-V0;

		深圳市华德共创科技有限公司 Shenzhen Huade co-create Technology Co.,LTD 电话: 0755-27129737 传真: 0755-29940187						
		-TOLERANCES- UNLESS OTHERWISE SPECIFIED 公差参数表				TITLE: 产品名称: BH3.5 (带扣) 母胶壳		
X.X	±0.30	X.X'	±3'	APPD: 核准: 谢亮	PART NO: 产品编号: HDGC3500HMA-2P			
X.XX	±0.30	X.XX'	±2'	CHECK: 校对: 王建国	DATE	SCALE	UNIT	CODE NUMBER
X.XXX	±0.10	X.XXX'	±1'	DRAW: 绘图: 黄艳兰	2013-07-05	1:1	mm	A001

修订 REV	标记 MARK	修改摘要 REVISION DESCRIPTION	签名 SIGNATURE	日期 DATE
AO		NEW DWG		2014-05-07

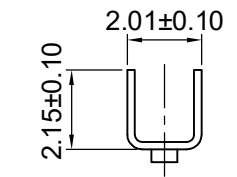
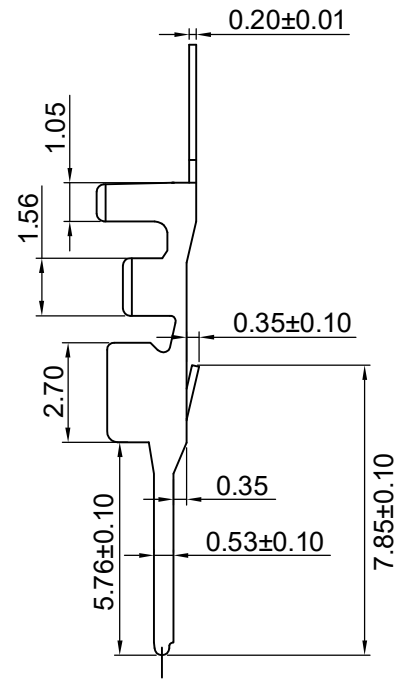
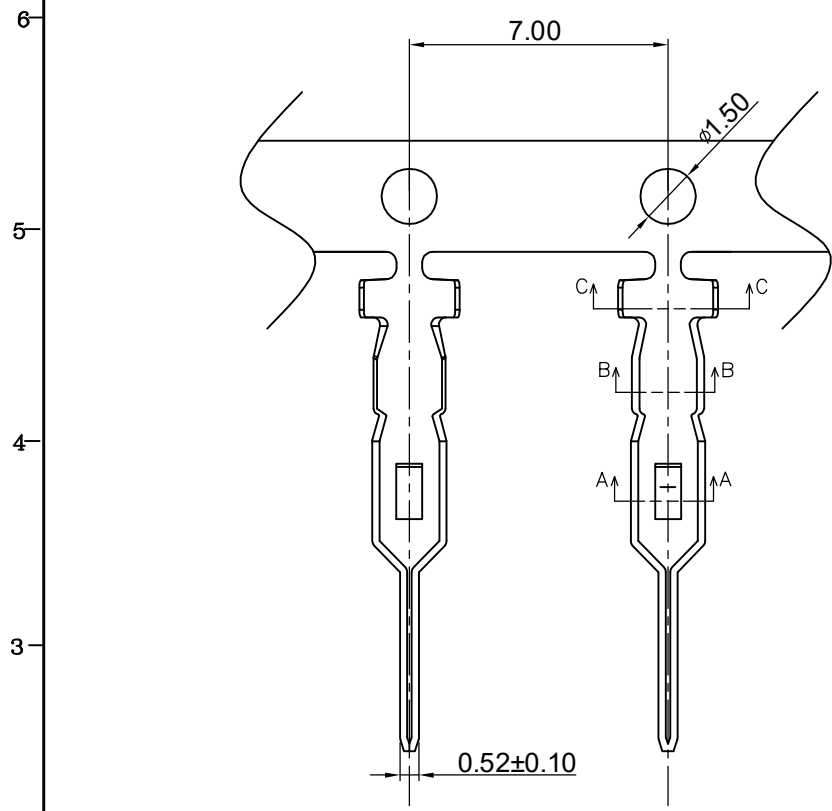

SECTION A-A

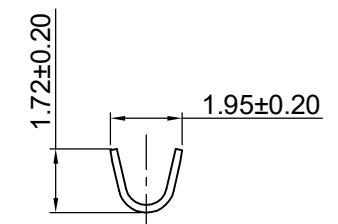

SECTION B-B

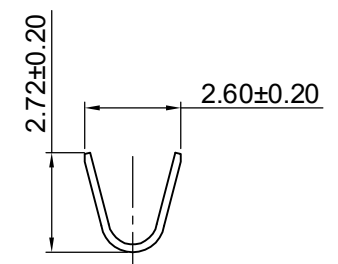

SECTION C-C

技术要求:

- 1、表面无垫伤、毛刺、变形，无明显划痕、斑点、花纹;
3. 材质: 黄铜 H65, T=0.20±0.01MM.



深圳市华德共创科技有限公司
Shenzhen Huade co-create Technology Co.,LTD
电话: 0755-27129737 传真: 0755-29940187

-TOLERANCES- UNLESS OTHERWISE SPECIFIED 公差参数表				TITLE: 产品名称: BH3.5(公)-TER					
X.X ±0.30	X.X' ±3'	APPD: 核准: 谢亮	PART NO: 产品编号: HDGC3500M-T		DATE		SCALE	UNIT	CODE NUMBER
X.XX ±0.30	X.XX' ±2'	CHECK: 校对: 王建业	DRAW: 绘图: 黄艳兰		2014-05-07	1:1	mm	A001	