

SMD INDUCTOR DR353-4 SERIES

Features

- Low Profile Surface Mount Design
- Flat Top for Pick and Place
- Inductance Range from 1.0 μ H to 33.0 μ H
- Operating Temp. -25°C to + 85°C
- Tinned Leads with Leaded Solder is Available (note 6)



ELECTRICAL SPECIFICATIONS AT 25°C

Part No.	Inductance (μ H)		DCR (Ω) Max.	I_{rated} (mA) Max.	SRF (MHz) Min.
DR353-4-102	1.0 \pm 20%	@1MHz	0.08	1080	100
DR353-4-152	1.5 \pm 20%	@1MHz	0.09	1000	85
DR353-4-222	2.2 \pm 20%	@1MHz	0.11	900	60
DR353-4-332	3.3 \pm 20%	@1MHz	0.13	800	47
DR353-4-472	4.7 \pm 20%	@1MHz	0.15	750	35
DR353-4-682	6.8 \pm 20%	@1MHz	0.20	720	30
DR353-4-103	10 \pm 10%	@1MHz	0.24	650	23
DR353-4-153	15 \pm 10%	@1MHz	0.32	570	20
DR353-4-223	22 \pm 10%	@1MHz	0.60	420	15
DR353-4-333	33 \pm 10%	@1MHz	1.00	310	12

MECHANICAL OUTLINES

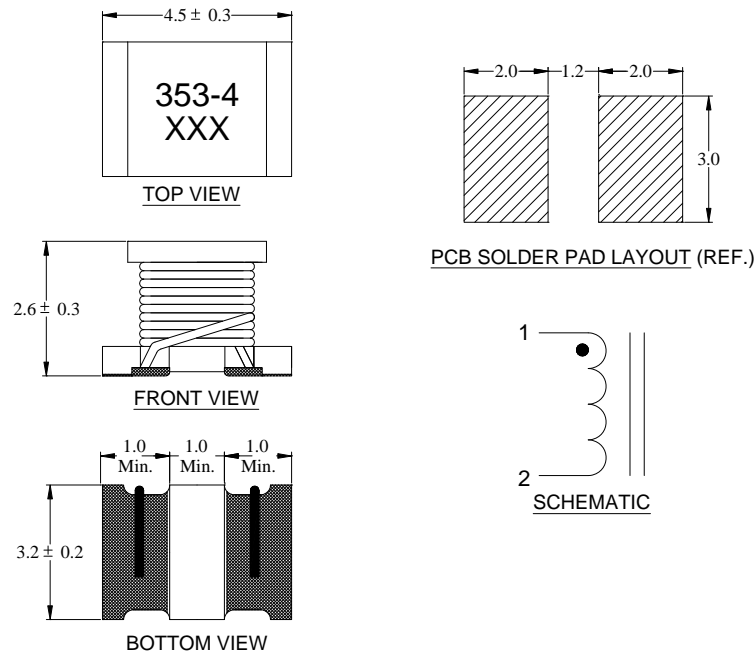

Notes:

1. All dimensions are shown in millimeter "mm"
2. General tolerance \pm 0.2mm, unless other specified
3. I_{rated} for an approximate 40°C temperature rise
4. I_{rated} for an approximate 20% drop maximum of the initial value
5. Tape and reel quantity, 500 pcs/reel
6. For non-RoHS parts replace DR prefix with 42- (e.g. DR353-4 becomes 42-353-4)
7. Terminal finish is compliant to RoHS requirements. Solder in accordance with J-STD-020D