

Applicable for automotive interior light

801 Series Bluish White

MSBT801G-B / STSBA12GE



Product Brief

Description

- This White Colored surface-mount LED comes in standard package dimension. Package Size: 3.5x2.8x1.9mm
- It has a substrate made up of a molded plastic reflector sitting on top of a lead frame.
- The die is attached within the reflector cavity and the cavity is encapsulated by silicone.
- The package design coupled with careful selection of component materials allow these products to perform with high reliability.

Features and Benefits

- White PLCC2 Sky Blue Color
- ESD min 2kV
- MSL 2a Level
- Viewing angle 120°
- AEC-Q101 Qualified
- RoHS compliant

Key Applications

- Interior automotive
- Electronic sign and signals
- Electrical Equipment, Home appliance

Table of Contents

| Index | |
|---------------------------------------|----|
| • Product Brief | 1 |
| • Table of Contents | 2 |
| • Performance Characteristics | 3 |
| • Characteristics Graph | 5 |
| • Color Bin Structure | 12 |
| • Reliability Test | 14 |
| • Mechanical Dimensions | 15 |
| • Material Structure | 16 |
| • Recommended Solder Pad | 17 |
| • Reflow Soldering Characteristics | 18 |
| • Emitter Tape & Reel Packaging | 19 |
| • Product Nomenclature | 21 |
| • Handling of Silicone Resin for LEDs | 22 |
| • Precaution For Use | 23 |
| • Company Information | 26 |

Performance Characteristics

Table 1. Electro Optical Characteristics, $I_F = 10\text{mA}$, $T_j = 25^\circ\text{C}$, RH30%

| Parameter | Symbol | Value | | | Unit |
|---|-------------------------------|-------|-------|-----|-----------------------------|
| | | Min | Typ | Max | |
| Forward Voltage ^[1] | V_F | 2.4 | 3.1 | 3.8 | V |
| Reverse Voltage | V_R ($I_R=5\text{mA}$) | | 0.9 | 1.2 | V |
| Luminous Intensity ^{[2] [1]} | I_V | 80 | 100 | 210 | mcd |
| Luminous Flux | Φ_V | | 300 | | mlm |
| Color Coordinate ^{[3] [1]} | X | | 0.158 | | - |
| | Y | | 0.090 | | - |
| Viewing Angle ^[4] | $2\theta_{1/2}$ | | 120 | | deg. |
| Optical Efficiency | η_{op} | | 9.68 | | lm/W |
| Thermal resistance ^[5] | $R_{th JA}$ | | 360 | | $^\circ\text{C} / \text{W}$ |
| | $R_{th JS}$ | | 180 | | $^\circ\text{C} / \text{W}$ |
| Temperature coefficient of V_F $-10^\circ\text{C} \leq T \leq 100^\circ\text{C}$ | TC_V | | -3.4 | | mV/ $^\circ\text{C}$ |
| Temperature coefficient of X $-10^\circ\text{C} \leq T \leq 100^\circ\text{C}$ | TC_x | | -0.16 | | $10^{-3}/^\circ\text{C}$ |
| Temperature coefficient of Y $-10^\circ\text{C} \leq T \leq 100^\circ\text{C}$ | TC_y | | -0.06 | | $10^{-3}/^\circ\text{C}$ |
| Luminous Intensity Phi V / IV | ∂_Ω | 3.0 | | 3.1 | lm/cd |

Notes :

- (1) Tolerance : $V_F : \pm 0.1\text{V}$, $I_V : \pm 10\%$, $x, y : \pm 0.005$
- (2) The luminous intensity I_V was measured at the peak of the spatial pattern which may not be aligned with the mechanical axis of the LED package.
- (3) Correlated Color is derived from the CIE 1931 Chromaticity diagram.
- (4) $\Theta_{1/2}$ is the off-axis where the luminous intensity is 1/2 of the peak intensity
- (5) Thermal resistance = $R_{th JA}$: Junction/ambient , $R_{th JS}$: Junction/solder point
Pad design for improved heat dissipation : Cu-area > Cu 16mm² per pad, FR4, t=1.6mm
- (6) Not designed for reverse operation

Performance Characteristics

Table 2. Absolute Maximum Ratings

| Parameter | Symbol | Value | Unit |
|---|-----------|---|------------------|
| Power Dissipation ($T_a=25^\circ\text{C}$) | P_d | 114 | mW |
| Forward Current ($T_a=25^\circ\text{C}$) | I_F | 30 | mA |
| Peak Forward Current ($t \leq 10\mu\text{sec}, D \leq 5/1000, T_a=25^\circ\text{C}$) | I_{FM} | 300 | mA |
| Operating Temperature | T_{opr} | -40 ~ +110 | $^\circ\text{C}$ |
| Storage Temperature | T_{stg} | -40 ~ +110 | $^\circ\text{C}$ |
| Junction Temperature | T_j | 125 | $^\circ\text{C}$ |
| Soldering Temperature | T_{sld} | Reflow Soldering : 260 $^\circ\text{C}$ for 10sec. Hand Soldering : 315 $^\circ\text{C}$ for 4sec. | |
| ESD (R=1.5k Ω , C= 100pF) ^[1] | | Min 2 | kV |

Notes :

(1) A zener diode is included for ESD Protection.

- LED's properties might be different from suggested values like above and below tables if operation condition will be exceeded our parameter range. Care is to be taken that power dissipation does not exceed the absolute maximum rating of the product.
- All measurements were made under the standardized environment of Seoul Semiconductor.

Characteristics Graph

Fig 1. Color Spectrum, $I_F = 10\text{mA}$, $T_j = 25^\circ\text{C}$, RH30%

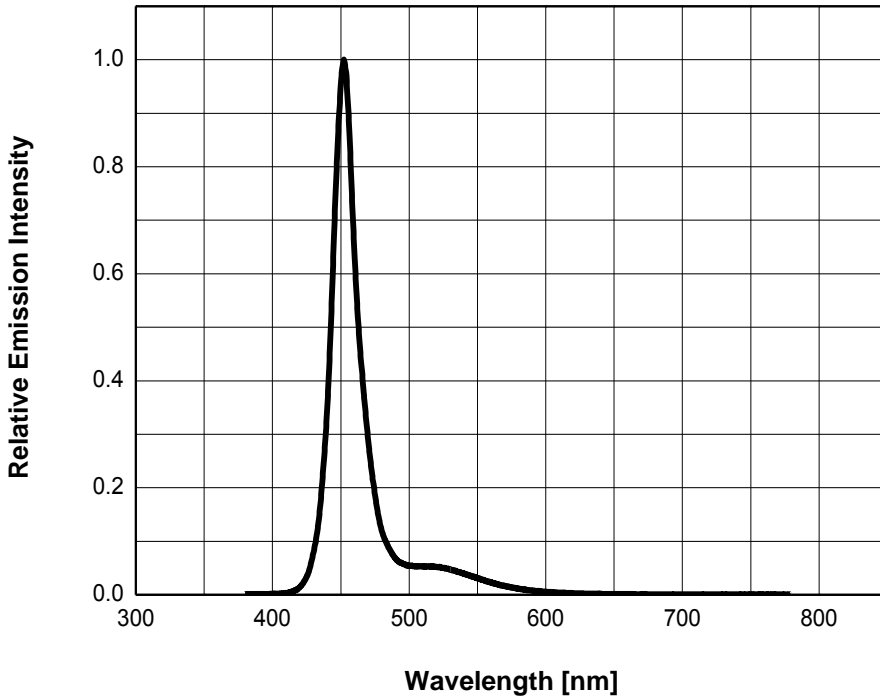
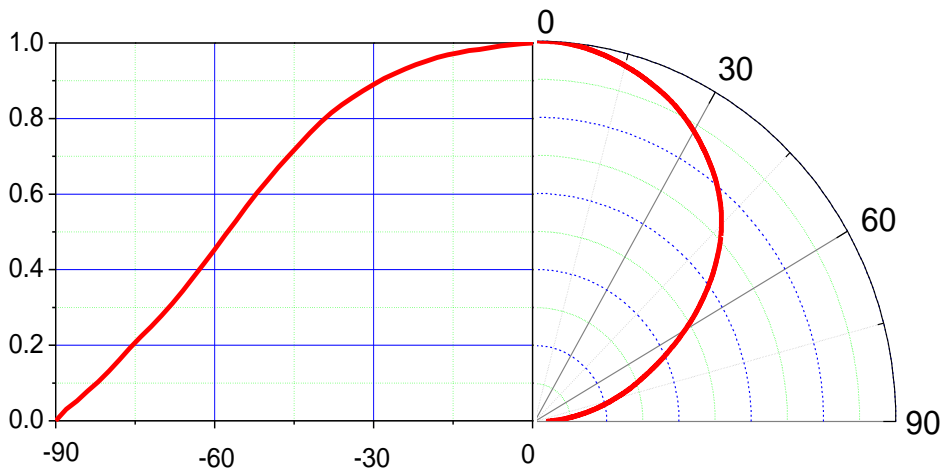

Fig 2. Viewing Angle Distribution, $I_F = 10\text{mA}$



Characteristics Graph

Fig 3. Forward Voltage vs. Forward Current , $T_j = 25^\circ\text{C}$

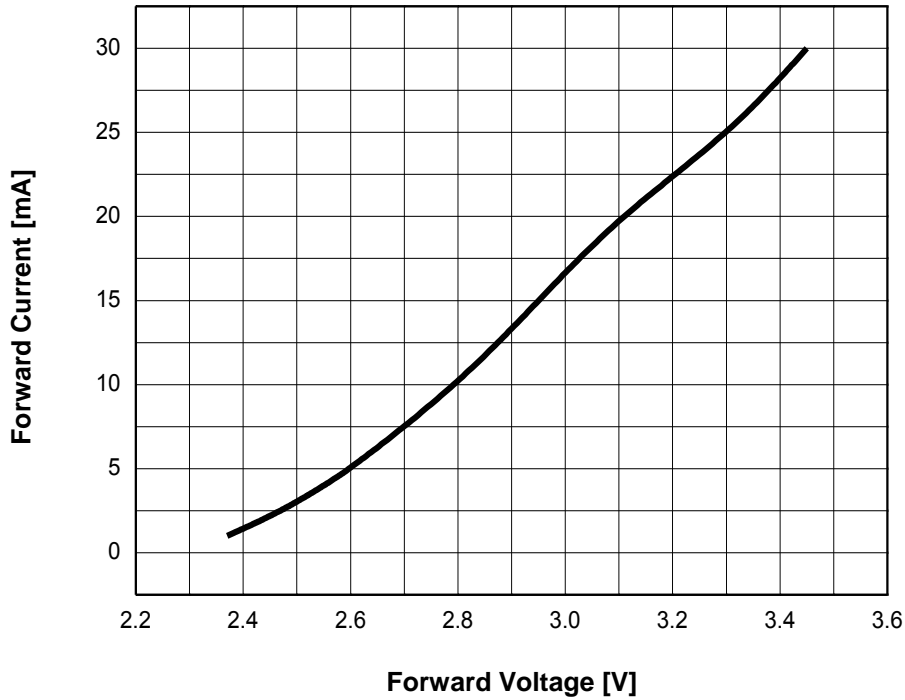
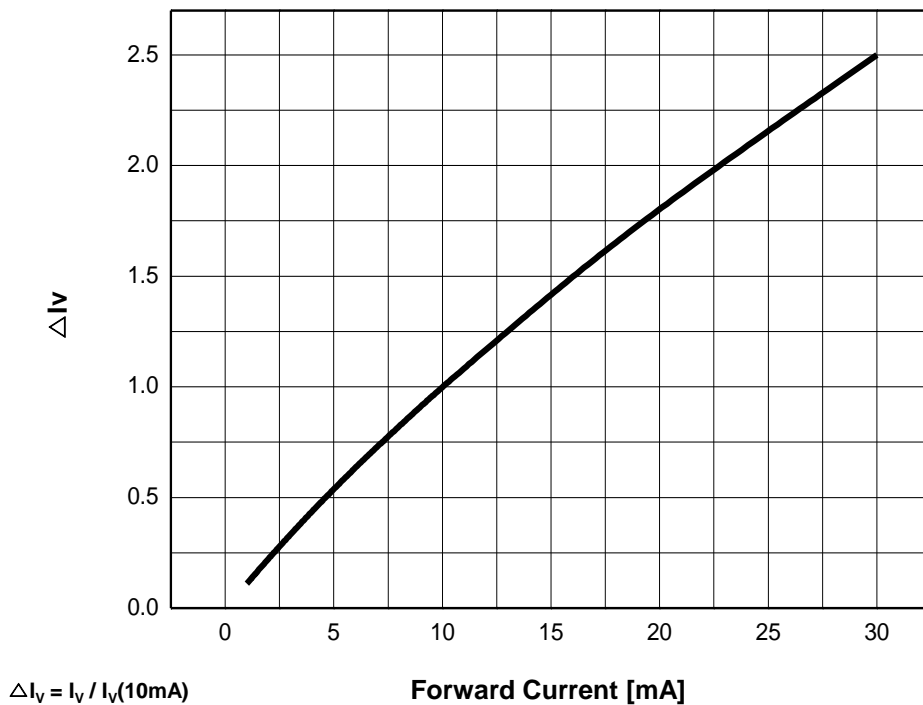
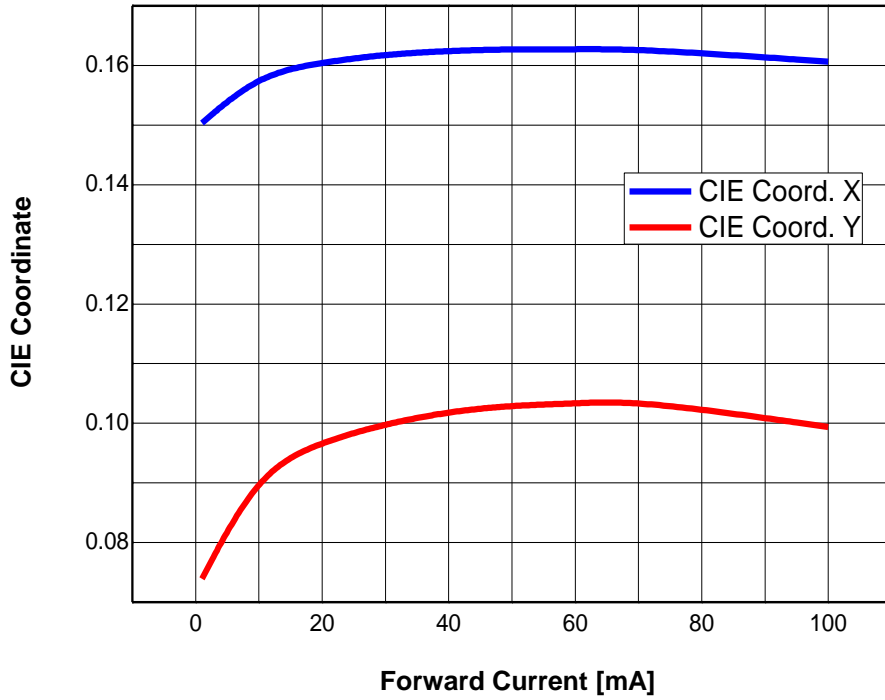

Fig 4. Forward Current vs. Relative Luminous Intensity, $T_j = 25^\circ\text{C}$



Characteristics Graph

Fig 5. Forward Current vs. CIE X, Y Shift, $T_j = 25^\circ\text{C}$



Characteristics Graph

Fig 6. Relative Light Output vs. Junction Temperature, $I_F = 10\text{mA}$

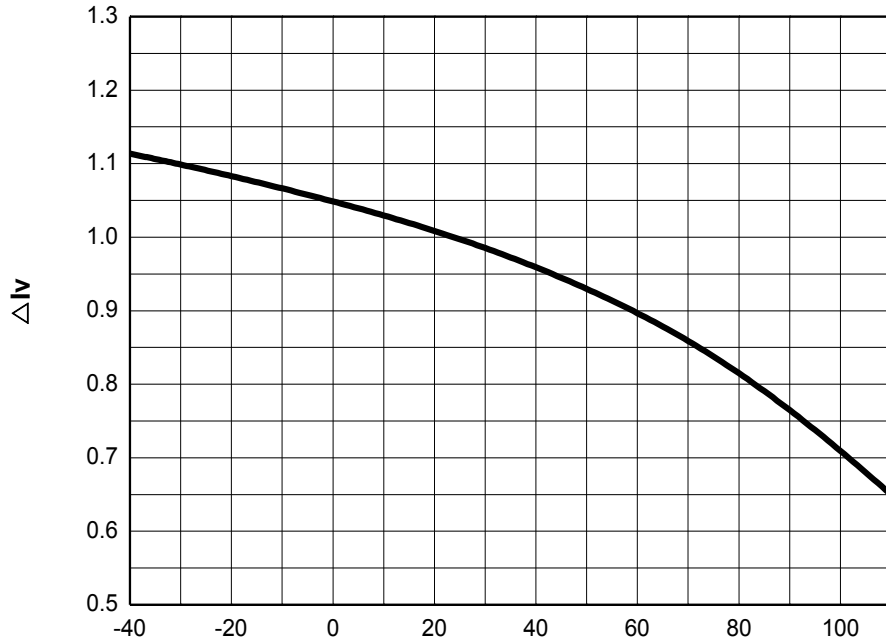

$$\Delta I_V = I_V / I_V(25^\circ\text{C})$$

Junction Temperature [°C]

Fig 7. Junction Temperature vs. Forward Voltage shift, $I_F = 10\text{mA}$

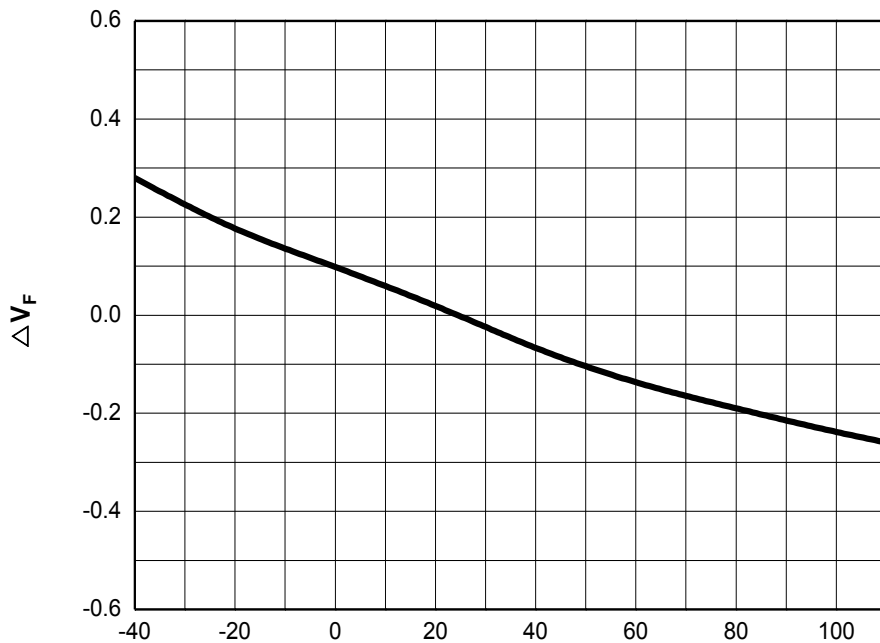

$$\Delta V_F = V_F - V_F(25^\circ\text{C})$$

Junction Temperature [°C]

Characteristics Graph

Fig 8. Chromaticity Coordinate vs. Junction Temperature, $I_f = 10\text{mA}$

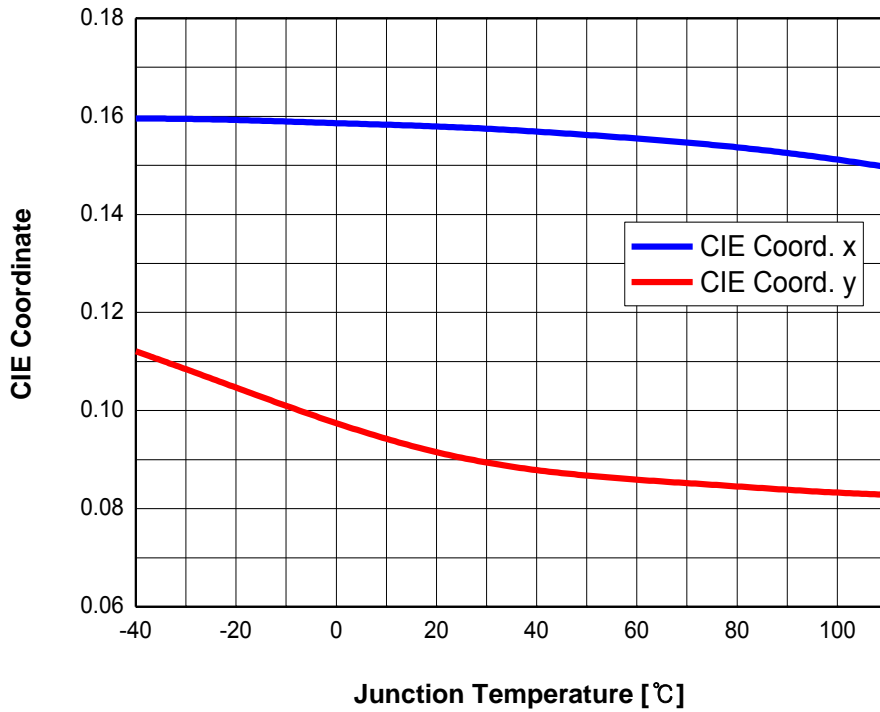

Characteristics Graph

Fig 9. Maximum Forward Current vs. Temperature

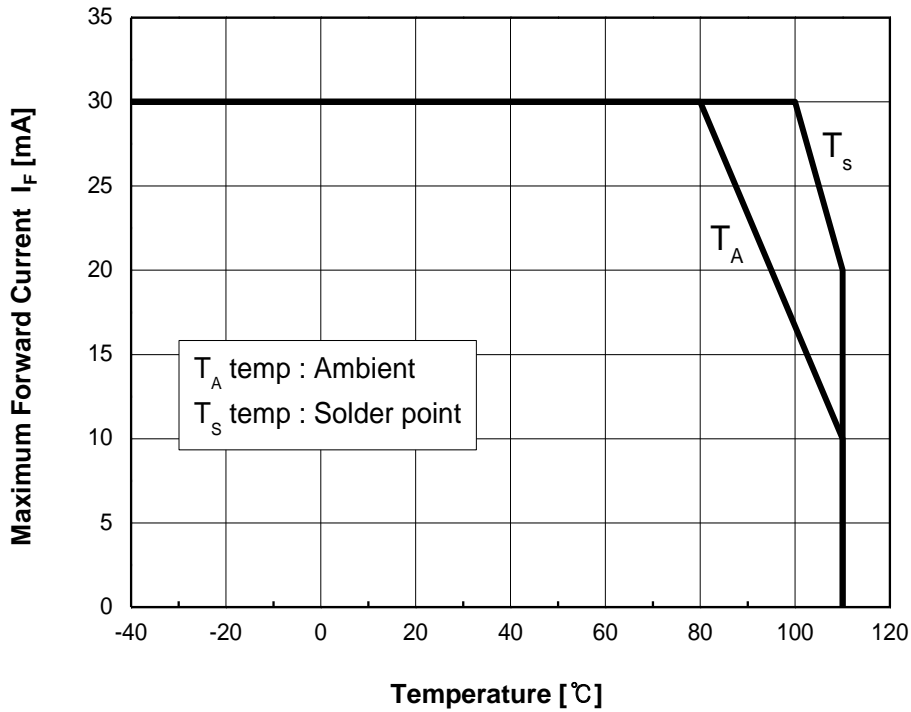
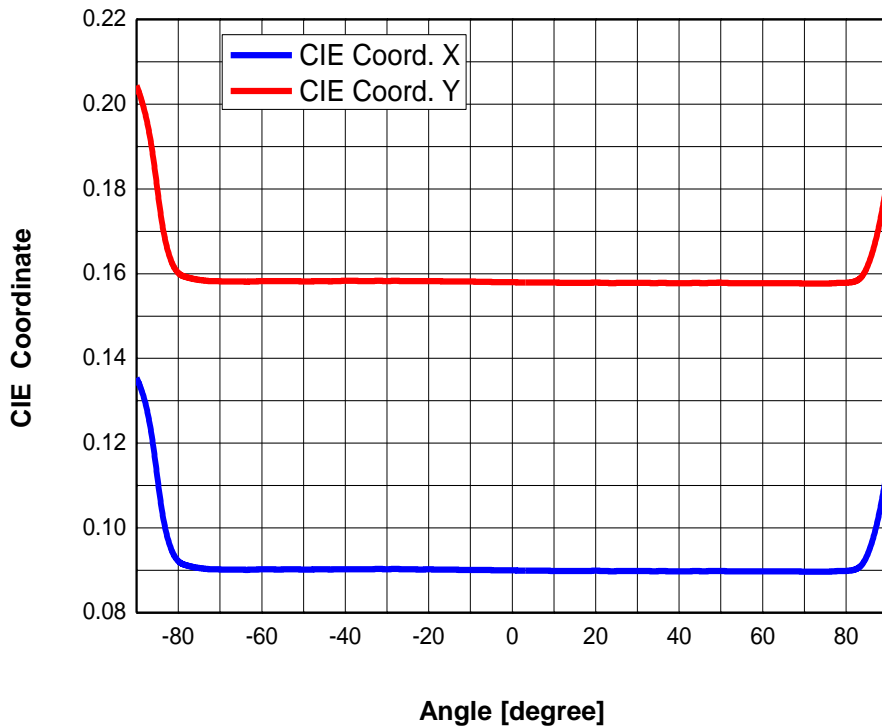

Fig 10. Color. vs. Viewing Angle, $T_j = 25^\circ\text{C}$, $I_F = 10\text{mA}$



Characteristics Graph

Fig 11. Maximum Forward Current vs. Duty Ratio, $T_j = 25^\circ\text{C}$

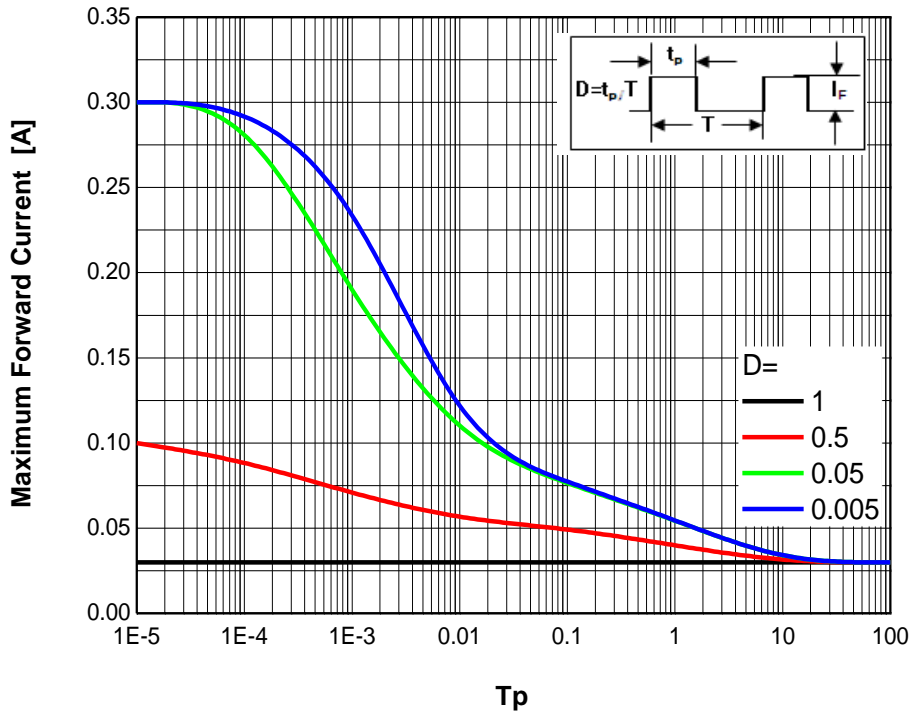
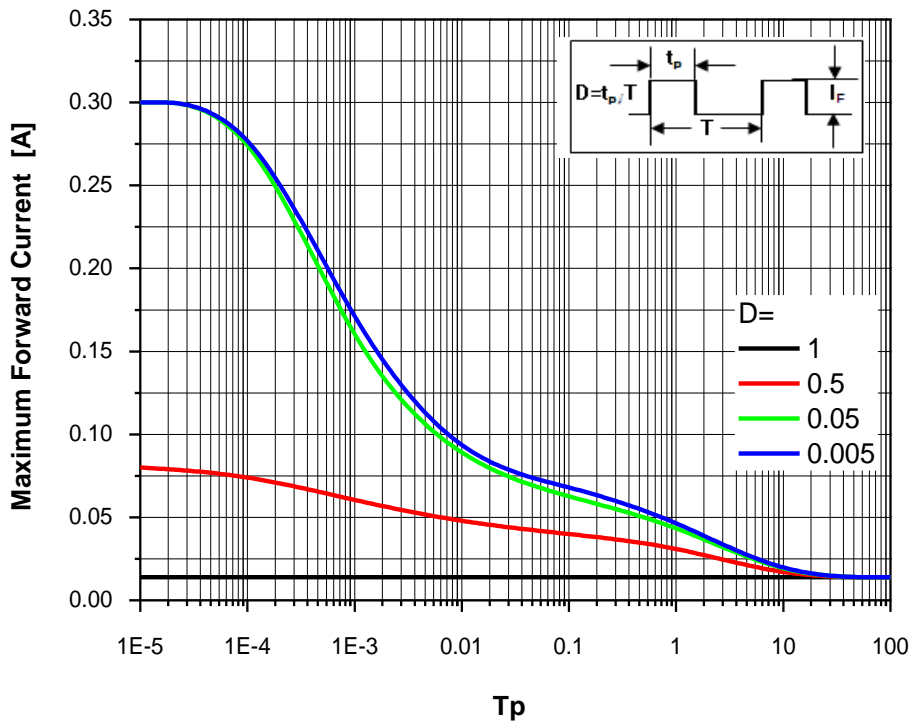

Fig 12. Maximum Forward Current vs. Duty Ratio, $T_j = 85^\circ\text{C}$



Color Bin Structure

Table 3. Bin Code description, $I_F = 10\text{mA}$, $T_j = 25^\circ\text{C}$

| Part Number | Luminous Intensity (mcd) | | | Color Chromaticity Coordinate | Forward Voltage (V) | | |
|-------------|--------------------------|------|------|-------------------------------|---------------------|------|------|
| | Bin Code | Min. | Max. | | Bin Code | Min. | Max. |
| MSBT801G-B | n | 80 | 150 | Refer to page.13 | A | 2.4 | 3.1 |
| | o | 150 | 210 | | B | 3.1 | 3.8 |

Available ranks

***Notes :**

(1) All measurements were made under the standardized environment of Seoul Semiconductor
In order to ensure availability, single color rank will not be orderable.

Color Bin Structure

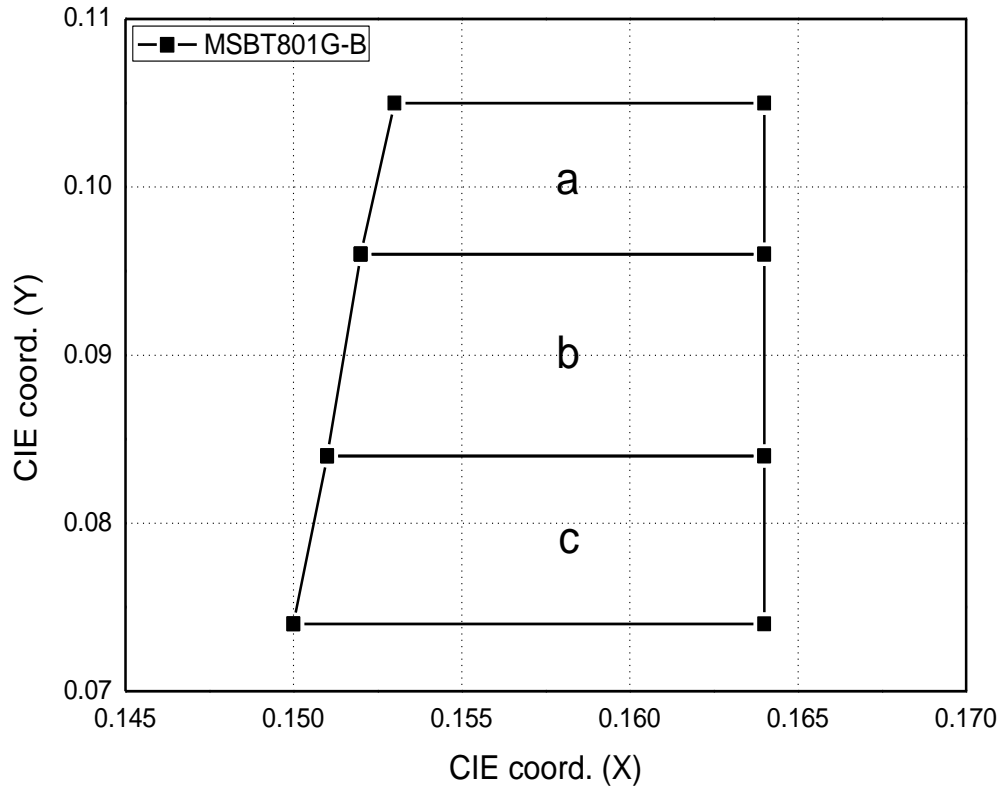
CIE Chromaticity Diagram, $I_F = 10\text{mA}$, $T_j = 25^\circ\text{C}$

| a | | b | | c | |
|--------|--------|--------|--------|--------|--------|
| CIE X | CIE Y | CIE X | CIE Y | CIE X | CIE Y |
| 0.1520 | 0.0960 | 0.1510 | 0.0840 | 0.1500 | 0.0740 |
| 0.1640 | 0.0960 | 0.1640 | 0.0840 | 0.1640 | 0.0740 |
| 0.1640 | 0.1050 | 0.1640 | 0.0960 | 0.1640 | 0.0840 |
| 0.1530 | 0.1050 | 0.1520 | 0.0960 | 0.1510 | 0.0840 |

***Notes :**

 •Measurement Uncertainty of the Color Coordinates : ± 0.005

Reliability Test

| Test Item | Standard Test Method | Test Condition | Duration / Cycle | Number Of Test |
|--|----------------------|--|----------------------------------|----------------|
| External Visual | JESD22 B-101 | Visual inspection | - | 77 |
| D.P.A | AEC-Q101-004 | Random Sample H3TRB,HAST,TC | - | 5 |
| Vibration | JESD22 B-103 | 0.06 inch displacement, 20 to 100 Hz, 50 g 100 Hz to 2kHz, | 4 times | 30 |
| ESD | JESD22 A-114 | Human-body mode, R=1.5k Ω , C = 100pF | 3 times Negative/ Positive | 30 |
| Physical Dimension | JESD22 B-100 | Verify physical dimensions against device mechanical drawing | 3 times | 30 |
| Mechanical Shock | JESD22 B-104 | 1500 g's for 0.5 ms, 5 blows, 3 orientations | 3 times | 30 |
| Parametric Verification | JESD22 A-108 | 25°C, 1000 hours @30mA | 1000hrs | 77 |
| Temperature cycling | JESD22 A-104 | T _c = -40° ~ 100°C, 30 min. dwell, 5 min transfer, 1000 cycles | 1000hrs | 77 |
| Power Temperature Cycle | JESD22 A-105 | T _a =-40°C ~85°C, I _f =25mA, 20 min dwell / 20 min transition (1 hour cycle), 2 min ON / 2 min OFF | 1000hrs | 77 |
| High Humidity High Temp. Operating Life | JESD22 A-101 | 85°C/85% RH, @ 25mA | 1000hrs | 77 |
| High Temperature Operating Life | JESD22 A-108C | T _a = 100°C, I _f =17mA | 1000hrs | 77 |
| Low Temperature Operating Life | JESD22 A-108C | T _a = -40°C, I _f = 30mA | 1000hrs | 77 |
| Low Temperature Storage Life | JESD22 A-119 | T _a =-40°C, non-operating | 1000hrs | 77 |
| High Temperature Storage Life | JESD22 A-103B | T _a =100°C, non-operating | 1000hrs | 77 |
| Thermal Shock | JESD22 A-104 | -40°C ~ 100°C, 20 min. dwell, <10 second transfer, 1000 cycles | 1000hrs | 77 |

Criteria for Judging the Damage

| Item | Symbol | Condition | Criteria for Judgment | |
|--------------------|----------------|----------------------|-----------------------|---------------|
| | | | MIN | MAX |
| Forward Voltage | V _F | I _F =10mA | - | Initial × 1.2 |
| Luminous Intensity | I _V | I _F =10mA | Initial × 0.8 | - |

Mechanical Dimensions

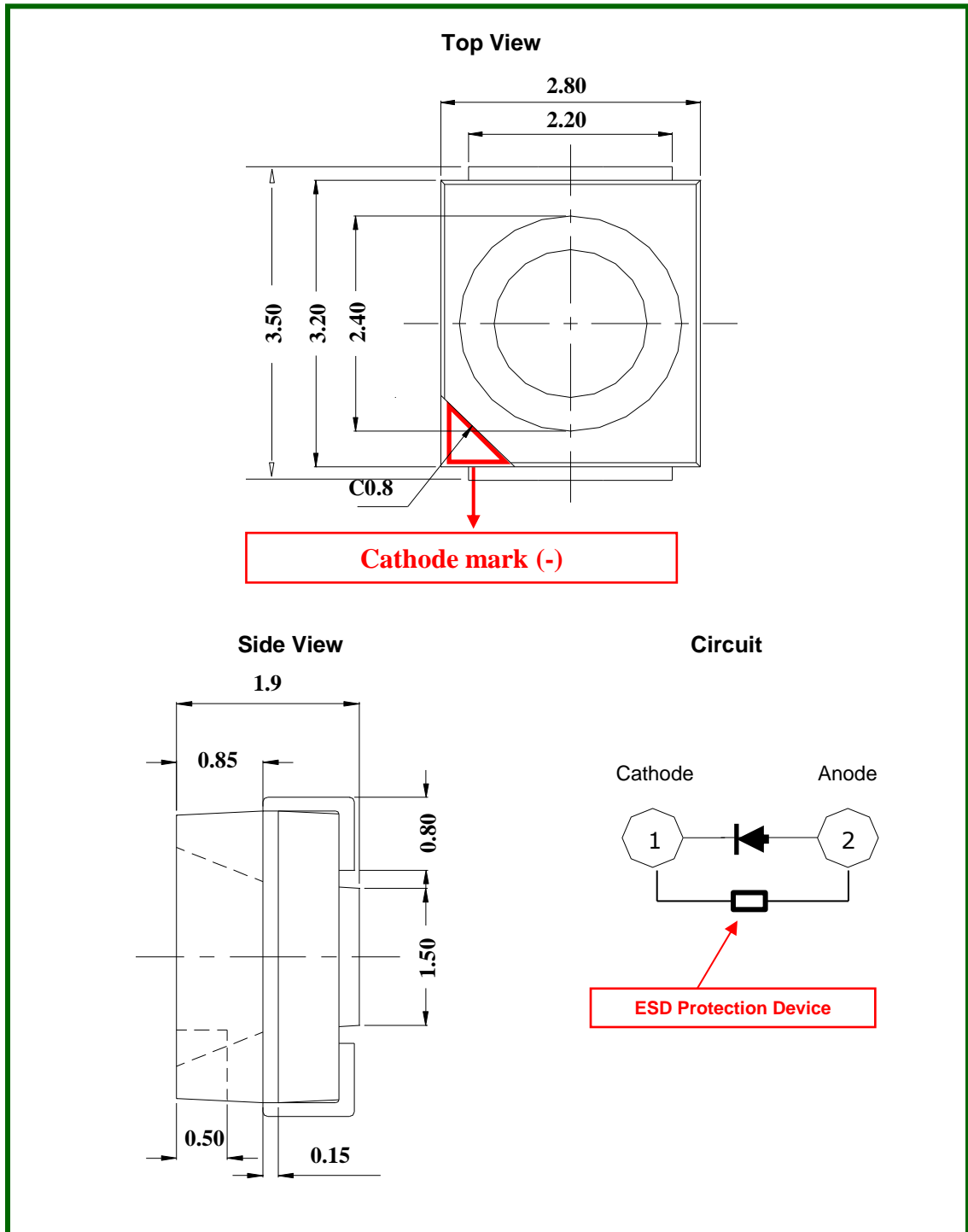

- (1) All dimensions are in millimeters.
- (2) Scale : none
- (3) Undefined tolerance is $\pm 0.1\text{mm}$

Material Structure

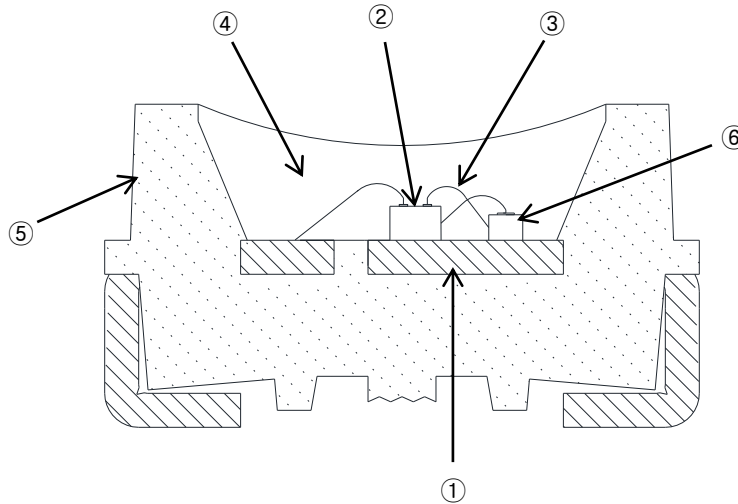

| Parts No. | Name | Description | Materials |
|-----------|-----------------------|-------------|-------------------------------|
| ① | LEAD FRAME | Metal | Copper Alloy (Gold Plated) |
| ② | Chip Source | Blue LED | GaN on Sapphire |
| ③ | Wire | Metal | Gold Wire |
| ④ | Encapsulation | Silicone | +Phosphor |
| ⑤ | Body | PPA | Heat-resistant Polymer |
| ⑥ | ESD Protection Device | Si | - |

Recommended Solder Pad

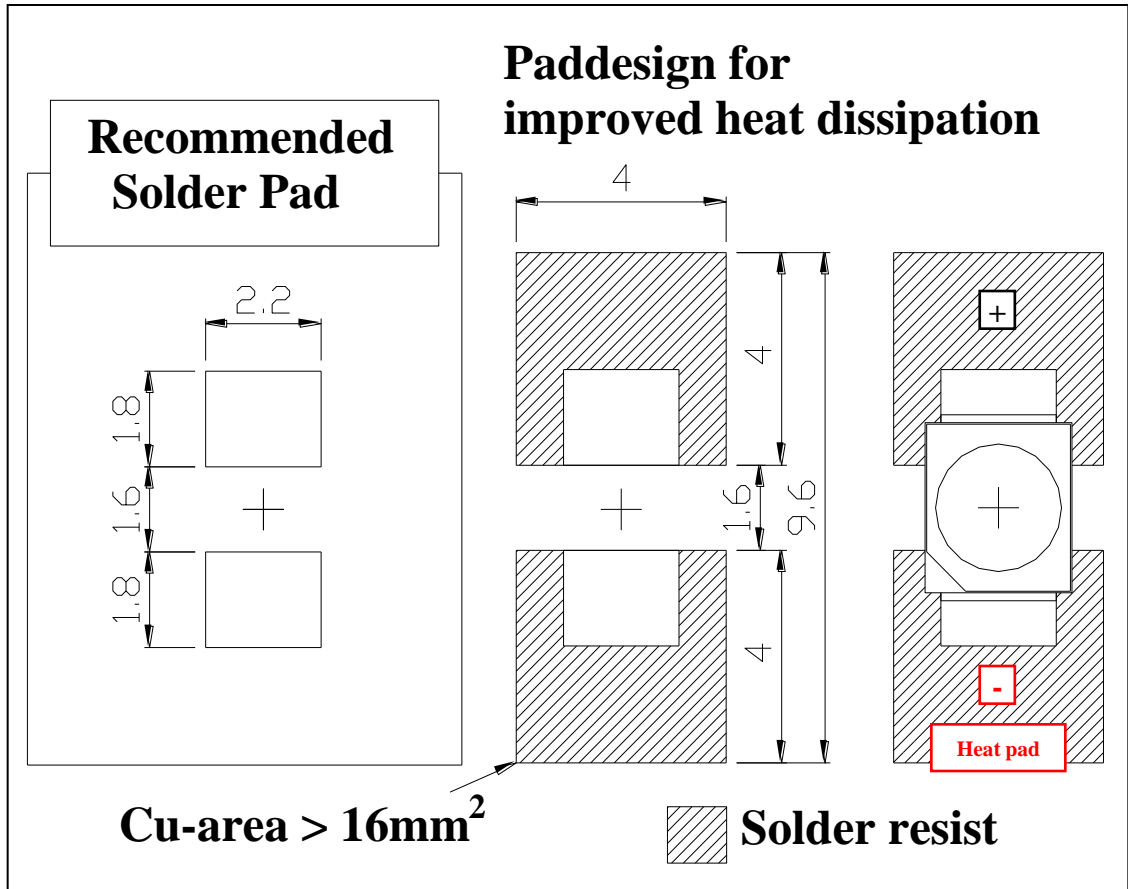
Notes :

- (1) All dimensions are in millimeters.
- (2) Scale : none
- (3) This drawing without tolerances are for reference only.
- (4) Undefined tolerance is $\pm 0.1\text{mm}$.

Reflow Soldering Characteristics

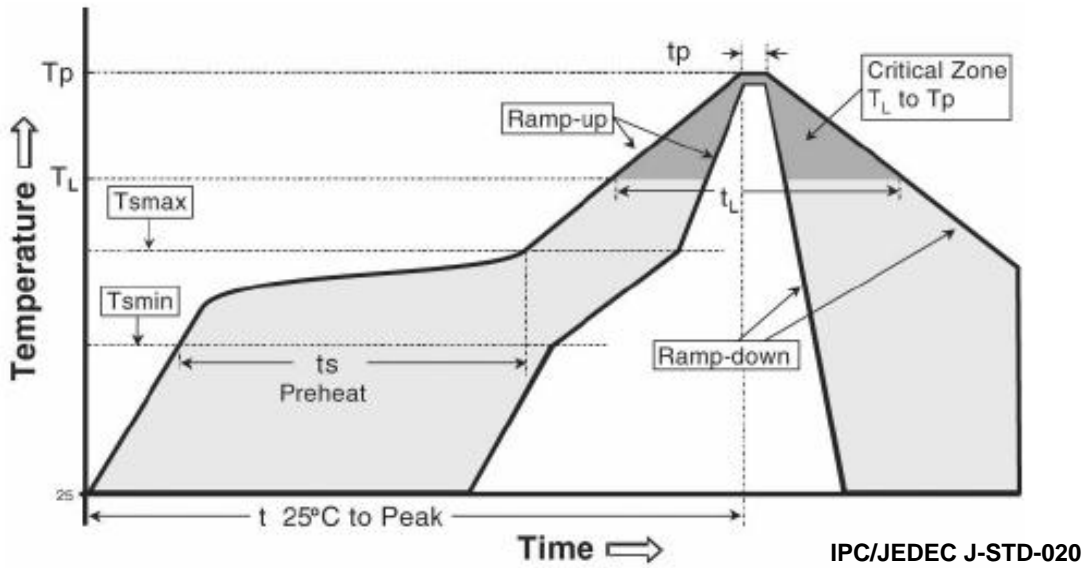

| Profile Feature | Sn-Pb Eutectic Assembly | Pb-Free Assembly |
|--|------------------------------------|------------------------------------|
| Average ramp-up rate (T _{max} to T _p) | 3° C/second max. | 3° C/second max. |
| Preheat - Temperature Min (T _{min}) - Temperature Max (T _{max}) - Time (T _{min} to T _{max}) (ts) | 100 °C 150 °C 60-120 seconds | 150 °C 200 °C 60-180 seconds |
| Time maintained above: - Temperature (T _L) - Time (t _L) | 183 °C 60-150 seconds | 217 °C 60-150 seconds |
| Peak Temperature (T _p) | 215 °C | 260 °C |
| Time within 5°C of actual Peak Temperature (tp) ² | 10-30 seconds | 20-40 seconds |
| Ramp-down Rate | 6 °C/second max. | 6 °C/second max. |
| Time 25°C to Peak Temperature | 6 minutes max. | 8 minutes max. |

Caution

- (1) Reflow soldering is recommended not to be done more than two times. In the case of more than 24 hours passed soldering after first, LEDs will be damaged.
- (2) Repairs should not be done after the LEDs have been soldered. When repair is unavoidable, suitable tools must be used.
- (3) Die slug is to be soldered.
- (4) When soldering, do not put stress on the LEDs during heating.
- (5) After soldering, do not warp the circuit board.

Emitter Tape & Reel Packaging

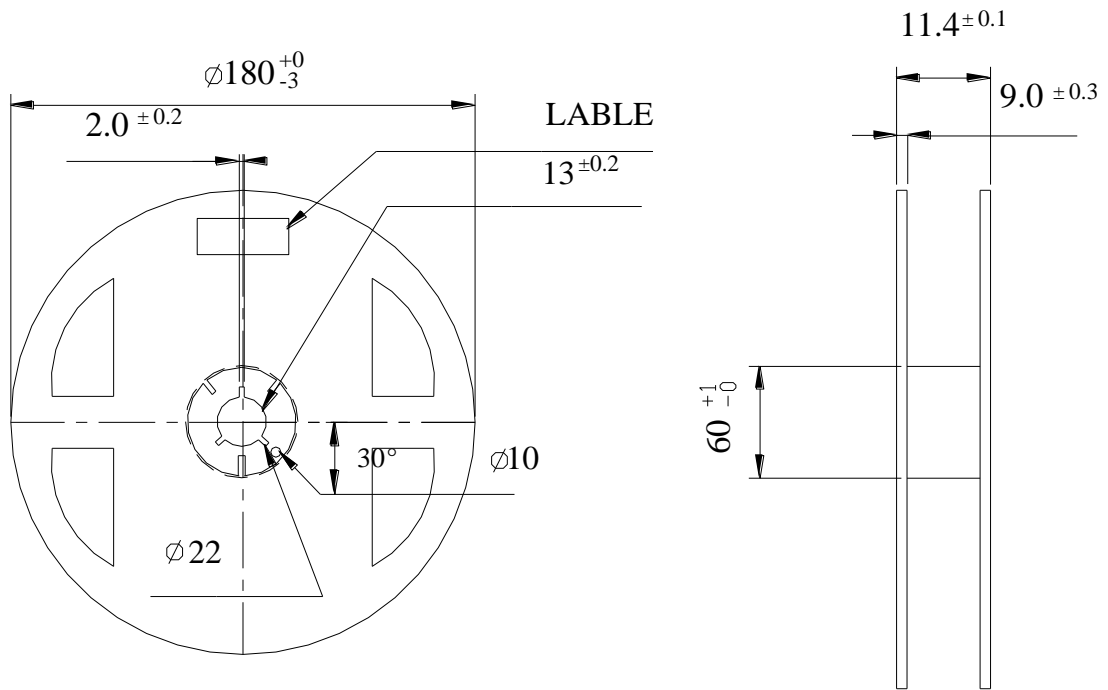
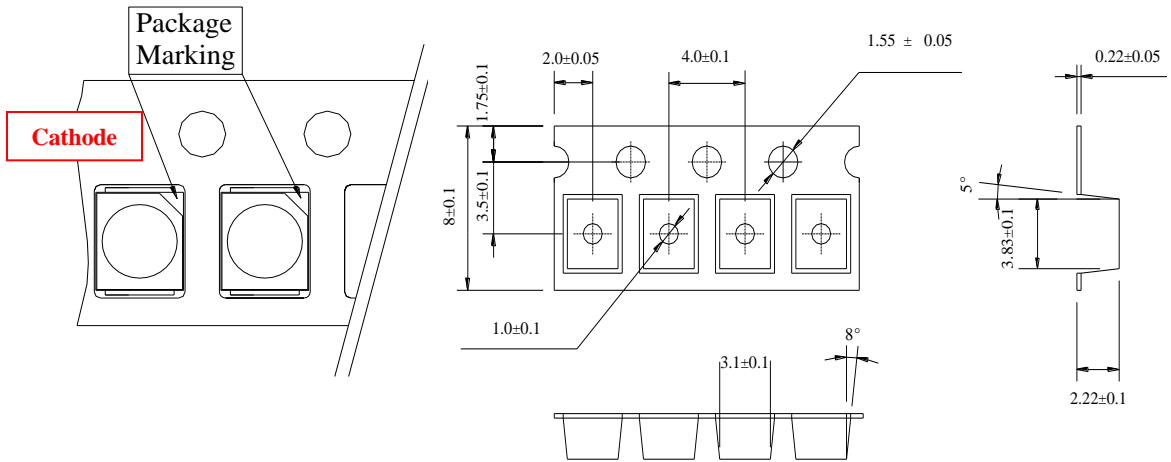

(Tolerance: ± 0.2 , Unit: mm)

- (1) Quantity : Max 2,000pcs/Reel
- (2) Cumulative Tolerance : Cumulative Tolerance/10 pitches to be ± 0.2 mm
- (3) Adhesion Strength of Cover Tape
Adhesion strength to be 0.1-0.7N when the cover tape is turned off from the carrier tape at the angle of 10° to the carrier tape.
- (4) Package : P/N, Manufacturing data Code No. and Quantity to be indicated on a damp proof Package.

Emitter Tape & Reel Packaging

Reel

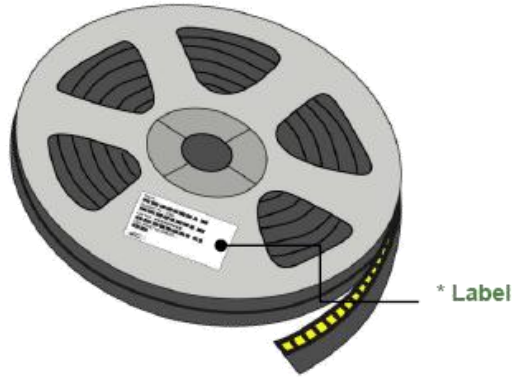

Aluminum Bag



* Label

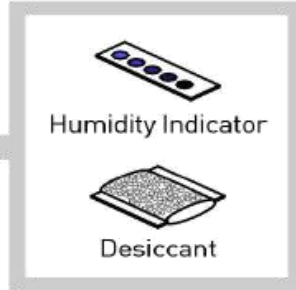
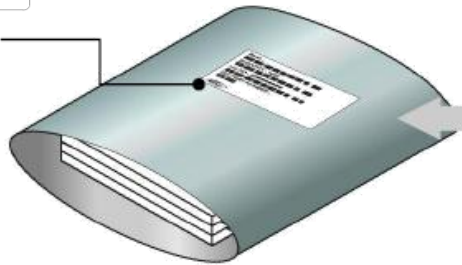

Outer Box



* Label

Product Nomenclature

Table 4. Part Numbering System : X₁X₂X₃X₄X₅X₆X₇X₈-X₉

| Part Number Code | Description | Part Number | Value |
|--|-------------------------|-------------|-------------|
| X ₁ | Company | M | SSC Code |
| X ₂ X ₃ | Color | SB | Sky Blue |
| X ₄ | Package Type | T | TOP VIEW |
| X ₅ X ₆ X ₇ | Package series | 801 | 801 series |
| X ₈ | Lead Frame Plated Types | G | Gold Plated |
| X ₉ | Product Revision | B | - |

Table 5. Lot Numbering System : Y₁Y₂Y₃Y₄Y₅Y₆Y₇Y₈Y₉Y₁₀-Y₁₁Y₁₂Y₁₃Y₁₄Y₁₅Y₁₆Y₁₇

| Lot Number Code | Description | Lot Number | Value |
|---|---------------------|------------|-------|
| Y ₁ Y ₂ | Year | | |
| Y ₃ | Month | | |
| Y ₄ Y ₅ | Day | | |
| Y ₆ | Top View LED series | | |
| Y ₇ Y ₈ Y ₉ Y ₁₀ | Mass order | | |
| Y ₁₁ Y ₁₂ Y ₁₃ Y ₁₄ Y ₁₅ Y ₁₆ Y ₁₇ | Internal Number | | |

Handling of Silicone Resin for LEDs

(1) During processing, mechanical stress on the surface should be minimized as much as possible. Sharp objects of all types should not be used to pierce the sealing compound.



(2) In general, LEDs should only be handled from the side. By the way, this also applies to LEDs without a silicone sealant, since the surface can also become scratched.

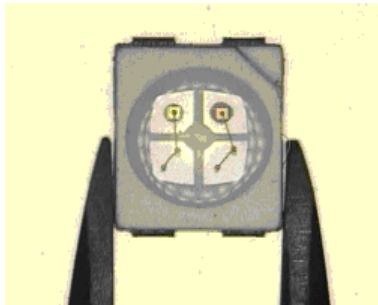

(3) When populating boards in SMT production, there are basically no restrictions regarding the form of the pick and place nozzle, except that mechanical pressure on the surface of the resin must be prevented. This is assured by choosing a pick and place nozzle which is larger than the LED's reflector area.

(4) Silicone differs from materials conventionally used for the manufacturing of LEDs. These conditions must be considered during the handling of such devices. Compared to standard encapsulants, silicone is generally softer, and the surface is more likely to attract dust.

As mentioned previously, the increased sensitivity to dust requires special care during processing. In cases where a minimal level of dirt and dust particles cannot be guaranteed, a suitable cleaning solution must be applied to the surface after the soldering of components.

(5) Seoul Semiconductor suggests using isopropyl alcohol for cleaning. In case other solvents are used, it must be assured that these solvents do not dissolve the package or resin. Ultrasonic cleaning is not recommended. Ultrasonic cleaning may cause damage to the LED.

(6) Please do not mold this product into another resin (epoxy, urethane, etc) and do not handle this product with acid or sulfur material in sealed space.

Precaution for Use

(1) Storage

To avoid the moisture penetration, we recommend store in a dry box with a desiccant.

The recommended storage temperature range is 5 °C to 30 °C and a maximum humidity of RH50%.

(2) Use Precaution after Opening the Packaging

Use proper SMT techniques when the LED is to be soldered dipped as separation of the lens may affect the light output efficiency.

Pay attention to the following:

a. Recommend conditions after opening the package

- Sealing

- Temperature : 5 ~ 30 °C Humidity : less than RH60%

b. If the package has been opened more than 4 week(MSL_2a) or the color of the desiccant changes, components should be dried for 10-24hr at 65±5 °C

(3) Do not apply mechanical force or excess vibration during the cooling process to normal temperature after soldering.

(4) Do not rapidly cool device after soldering.

(5) Components should not be mounted on warped (non coplanar) portion of PCB.

(6) Radioactive exposure is not considered for the products listed here in.

(7) Gallium arsenide is used in some of the products listed in this publication.

These products are dangerous if they are burned or shredded in the process of disposal.

It is also dangerous to drink the liquid or inhale the gas generated by such products when chemically disposed of.

(8) This device should not be used in any type of fluid such as water, oil, organic solvent and etc.

When washing is required, IPA (Isopropyl Alcohol) should be used.

(9) When the LEDs are in operation the maximum current should be decided after measuring the package temperature.

(10) LEDs must be stored in a clean environment. We recommend LEDs store in nitrogen-filled container.

Precaution for Use

- (11) The appearance and specifications of the product may be modified for improvement without notice.
- (12) Long time exposure of sunlight or occasional UV exposure will cause lens discoloration.
- (13) VOCs (Volatile organic compounds) emitted from materials used in the construction of fixtures can penetrate silicone encapsulants of LEDs and discolor when exposed to heat and photonic energy. The result can be a significant loss of light output from the fixture. Knowledge of the properties of the materials selected to be used in the construction of fixtures can help prevent these issues.
- (14) Attaching LEDs, do not use adhesives that outgas organic vapor.
- (15) The driving circuit must be designed to allow forward voltage only when it is ON or OFF.
If the reverse voltage is applied to LED, migration can be generated resulting in LED damage.
- (16) Similar to most Solid state devices;
LEDs are sensitive to Electro-Static Discharge (ESD) and Electrical Over Stress (EOS).
Below is a list of suggestions that Seoul Semiconductor purposes to minimize these effects.

a. ESD (Electro Static Discharge)

Electrostatic discharge (ESD) is defined as the release of static electricity when two objects come into contact. While most ESD events are considered harmless, it can be an expensive problem in many industrial environments during production and storage. The damage from ESD to LEDs may cause the product to demonstrate unusual characteristics such as:

- Increase in reverse leakage current lowered turn-on voltage
- Abnormal emissions from the LED at low current

The following recommendations are suggested to help minimize the potential for an ESD event. One or more recommended work area suggestions:

- Ionizing fan setup
- ESD table/shelf mat made of conductive materials
- ESD safe storage containers

One or more personnel suggestion options:

- Antistatic wrist-strap
- Antistatic material shoes
- Antistatic clothes

Environmental controls:

- Humidity control (ESD gets worse in a dry environment)

Precaution for Use

b. EOS (Electrical Over Stress)

Electrical Over-Stress (EOS) is defined as damage that may occur when an electronic device is subjected to a current or voltage that is beyond the maximum specification limits of the device. The effects from an EOS event can be noticed through product performance like:

- Changes to the performance of the LED package
(If the damage is around the bond pad area and since the package is completely encapsulated the package may turn on but flicker show severe performance degradation.)
- Changes to the light output of the luminaire from component failure
- Components on the board not operating at determined drive power

Failure of performance from entire fixture due to changes in circuit voltage and current across total circuit causing trickle down failures. It is impossible to predict the failure mode of every LED exposed to electrical overstress as the failure modes have been investigated to vary, but there are some common signs that will indicate an EOS event has occurred:

- Damaged may be noticed to the bond wires (appearing similar to a blown fuse)
- Damage to the bond pads located on the emission surface of the LED package
(shadowing can be noticed around the bond pads while viewing through a microscope)
- Anomalies noticed in the encapsulation and phosphor around the bond wires
- This damage usually appears due to the thermal stress produced during the EOS event

c. To help minimize the damage from an EOS event Seoul Semiconductor recommends utilizing:

- A surge protection circuit
- An appropriately rated over voltage protection device
- A current limiting device



Company Information

Published by

Seoul Semiconductor © 2013 All Rights Reserved.

Company Information

Seoul Semiconductor (www.SeoulSemicon.com) manufactures and packages a wide selection of light emitting diodes (LEDs) for the automotive, general illumination/lighting, Home appliance, signage and back lighting markets. The company is the world's fifth largest LED supplier, holding more than 10,000 patents globally, while offering a wide range of LED technology and production capacity in areas such as "nPola", "Acrich", the world's first commercially produced AC LED, and "Acrich MJT - Multi-Junction Technology" a proprietary family of high-voltage LEDs.

The company's broad product portfolio includes a wide array of package and device choices such as Acrich and Acirch2, high-brightness LEDs, mid-power LEDs, side-view LEDs, and through-hole type LEDs as well as custom modules, displays, and sensors.

Legal Disclaimer

Information in this document is provided in connection with Seoul Semiconductor products. With respect to any examples or hints given herein, any typical values stated herein and/or any information regarding the application of the device, Seoul Semiconductor hereby disclaims any and all warranties and liabilities of any kind, including without limitation, warranties of non-infringement of intellectual property rights of any third party. The appearance and specifications of the product can be changed to improve the quality and/or performance without notice.