

General Description

The AAT1130 SwitchReg™ is a member of AnalogicTech's Total Power Management IC™ product family. It is a fixed-frequency (during steady-state operation), current-mode step-down converter. The unique architecture improves transient response while allowing tiny passive LC filter components. The high switching frequency (up to 2.5MHz) keeps output voltage ripple low.

The AAT1130 delivers up to 500mA of output current, while consuming only 60µA of quiescent current. The current-mode control circuit operates at a fixed switching frequency in steady-state operation. It allows the control circuit to react nearly instantly for improved transient response and is stable with LC components as small as 1µH and 4.7µF. The AAT1130 regulates an output voltage between 0.6V and 1.8V from an input voltage of 2.7V to 5.5V. The AAT1130 is available in either fixed or adjustable output regulation voltage options, for the adjustable version the output voltage is set by an external resistor voltage divider circuit. Internal MOSFET switches reduce the overall solution size while maintaining high efficiency over a wide load current range.

The AAT1130 is available in a space saving 2.0x2.2mm SC70JW-10 package, and is rated over the -40°C to 85°C temperature range.

Features

- 2.5MHz Switching Frequency
- Input Voltage Range: 2.7V to 5.5V
- Output Voltage Range: 0.6V to 1.8V
- High 92% Peak Efficiency ($V_{IN} = 3.6V$, $V_{OUT} = 1.8V$)
- Low 60µA Quiescent Current
- 500mA Maximum Continuous Output Current
- Fast Transient Response with Small LC Output Filter Components
- Fixed and Adjustable Output Voltage Options
- Internal Soft-Start
- Anti-Ringing Switch to Reduce EMI During Discontinuous Conduction Mode Operation
- Over-Temperature Protection
- Valley Current Limit Protection
- Available in SC70JW-10
- -40°C to 85°C Temperature Range

Applications

- Microprocessor/DSP Core and I/O
- Mobile Phones
- PDAs and Handheld Computers
- Digital Cameras
- Portable Music Players
- Handheld Games
- Handheld Instruments

Typical Application

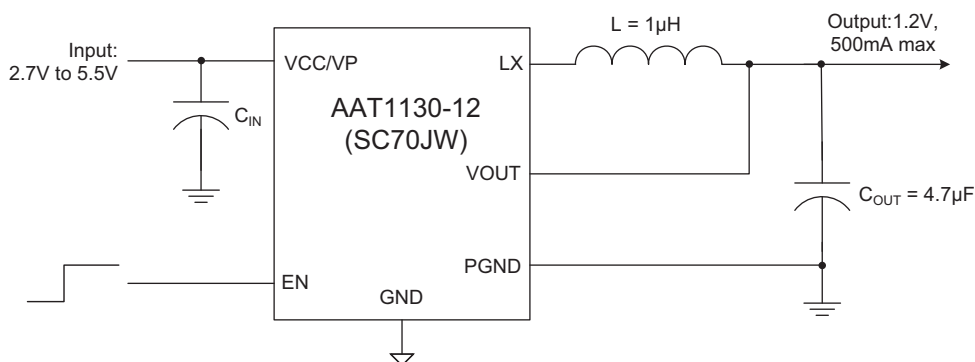

Pin Descriptions

Adj.	Fixed	Symbol	Function
1	n/a	FB	Output voltage feedback input. FB senses the output voltage through a resistor voltage divider circuit. Connect the voltage divider from the output voltage to FB. The feedback threshold is 0.6V. (Adjustable output voltage versions only)
2	2	VOUT	Output voltage feedback input. VOUT senses the output voltage. Connect VOUT to the output voltage node to regulate the output voltage.
3	3	VCC	Input supply voltage. Connect VCC to the input supply voltage.
4	4	VP	Power input supply voltage. Connect VP to the VCC pin, and to the input supply voltage. Bypass VP to PGND with a 2.2μF or greater capacitor.
5	5	LX	Switching node. Connect the LC filter between LX and the load. LX is internally connected to the drain of the p-channel MOSFET switch and n-channel MOSFET synchronous rectifier.
6	1	EN	Enable input. Active logic high.
n/a	6	PGND	Power ground. Connect PGND to GND at a single point as close to the AAT1130 as possible.
7, 8, 9, 10	7, 8, 9, 10	GND	Ground. For fixed version, connect GND to PGND at a single point as close to the AAT1130-xx as possible.

Pin Configuration

SC70JW-10 (Top View)

Adjustable Output Voltage Version

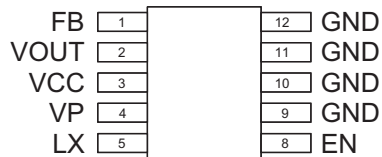

Fixed Output Voltage Version

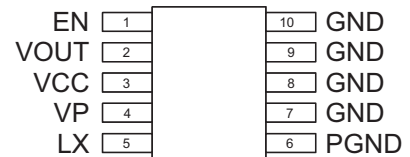

Absolute Maximum Ratings¹

Symbol	Description	Value	Units
V_{VCC}, V_{VP}	VCC, VP to GND	6.0	V
V_{LX}	LX Voltage to PGND	-0.3 to $V_{VCC} \setminus V_{VP} + 0.3$	V
V_{FB}	FB Voltage to GND	-0.3 to $V_{VCC} \setminus V_{VP} + 0.3$	V
V_{EN}	EN Voltage to GND	-0.3 to $V_{VCC} \setminus V_{VP} + 0.3$	V
V_{PGND}	PGND Voltage to GND	-0.3 to 0.3	V
T_J	Operating Junction Temperature Range	-40 to 150	°C
T_{LEAD}	Maximum Soldering Temperature (at leads, 10 sec)	300	°C

Thermal Information

Symbol	Description	Value	Units
P_D	Maximum Power Dissipation	625	mW
θ_{JA}	Thermal Resistance ²	160	°C/W

1. Stresses above those listed in Absolute Maximum Ratings may cause permanent damage to the device. Functional operation at conditions other than the operating conditions specified is not implied. Only one Absolute Maximum Rating should be applied at any one time.

2. Mounted on a FR4 board.

Electrical Characteristics¹

$V_{IN} = 3.6V$, $C_{IN} = C_{OUT} = 4.7\mu F$, $L = 1\mu H$. $T_A = -40^\circ C$ to $85^\circ C$, unless otherwise noted. Typical values are $T_A = 25^\circ C$.

Symbol	Description	Conditions	Min	Typ	Max	Units
V_{IN}	Input Voltage		2.7		5.5	V
V_{OUT}	Output Voltage Range		0.6		1.8	V
V_{UVLO}	UVLO Threshold	V_{IN} rising			2.65	V
		Hysteresis		100		mV
I_Q	Quiescent Current	Not Switching		60	90	μA
I_{SHDN}	Shutdown Current	EN = AGND = PGND			1.0	μA
V_{OUT_TOL} (fixed output version)	Output Voltage Tolerance	$V_{IN} = 2.7V$ to $5.5V$, 0 to 500mA Load	-4		4	%
V_{FB_ACC}	Feedback Voltage Accuracy	$T_A = 25^\circ C$, No Load	0.59	0.6	0.61	V
I_{LTM}	Valley Current Limit		550	650		mA
$R_{DS(ON)H}$	High Side Switch On-Resistance			0.35		Ω
$R_{DS(ON)L}$	Low Side Switch On-Resistance			0.25		Ω
t_{ON}	Switch On-Time	$V_{IN} = 3.6V$, $V_{OUT} = 1.2V$		120		ns
$t_{OFF(MIN)}$	Minimum Off-Time			75		ns
I_{LXLEAK}	LX Leakage Current	$V_{IN} = 5.5$, $V_{LX} = 0$ to V_{IN}			1	μA
I_{FBLEAK}	FB Leakage Current	$V_{FB} = 5.5V$, $V_{EN} = 0V$, Adj Only			0.2	μA
t_S	Startup Time	From EN Asserted to Output Regulation		150		μs
f_S	Switching Frequency	$V_{OUT} = 1.2V$, 500mA Load		2.5		MHz
T_{SD}	Over-Temperature Shutdown Threshold			140		$^\circ C$
T_{HYS}	Over-Temperature Shutdown Hysteresis			15		$^\circ C$
$V_{EN(L)}$	Enable Threshold Low				0.6	V
$V_{EN(H)}$	Enable Threshold High		1.4			V
I_{EN}	Enable Pin Current	$V_{IN} = V_{FB} = 5.5V$	-1.0		1.0	μA

1. The AAT1130 is guaranteed to meet performance specifications over the $-40^\circ C$ to $+85^\circ C$ operating temperature range and is assured by design, characterization, and correlation with statistical process controls.

Typical Characteristics

Efficiency vs. Load Current
($V_{OUT} = 1V$)

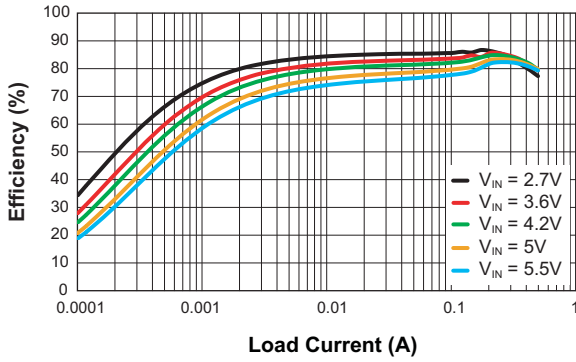

Output Voltage Error vs. Load Current
($V_{OUT} = 1V$)

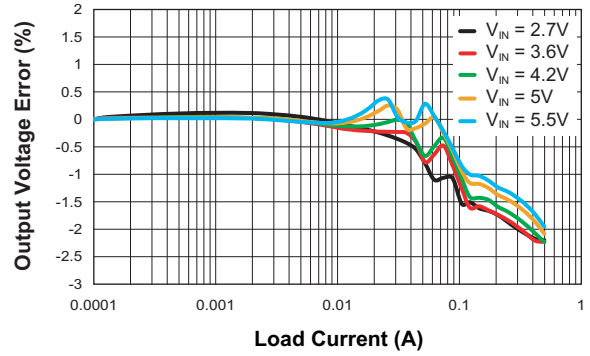

Line Regulation
($V_{OUT} = 1V$)

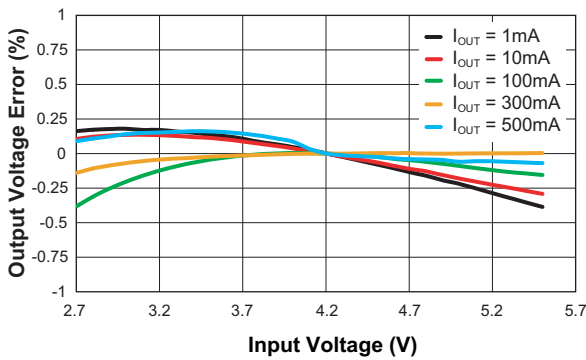

Efficiency vs. Load Current
($V_{OUT} = 1.8V$)

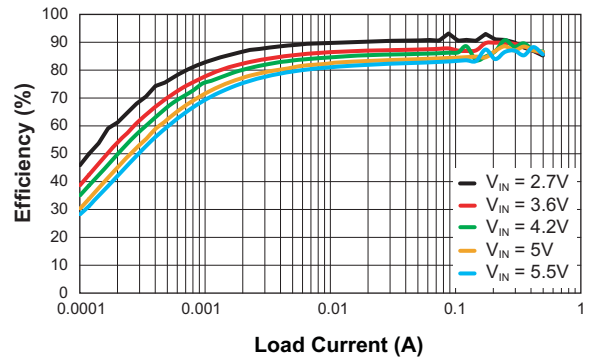

Output Voltage Error vs. Load Current
($V_{OUT} = 1.8V$)

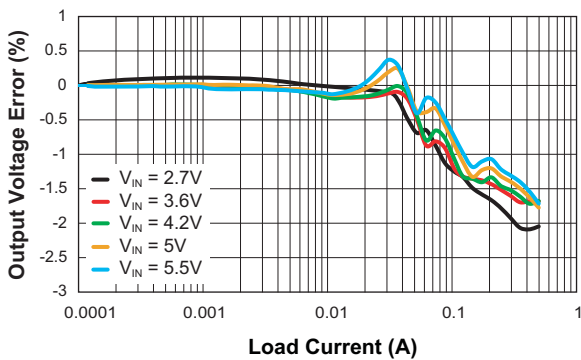

Line Regulation
($V_{OUT} = 1.8V$)

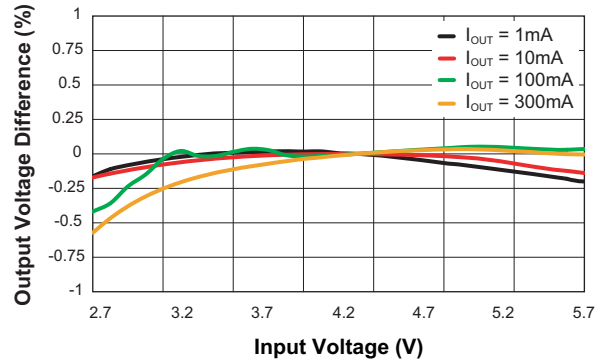

Typical Characteristics

Supply Current vs. Supply Voltage (Switching)

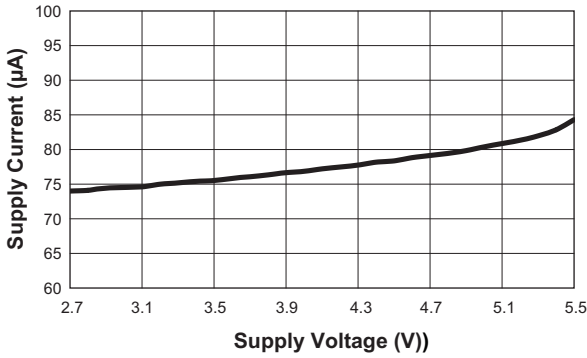

Switching Frequency vs. Input Voltage (V_{OUT} = 1V; C_{IN} = C_{OUT} = 2.2µF; L = 1µH)

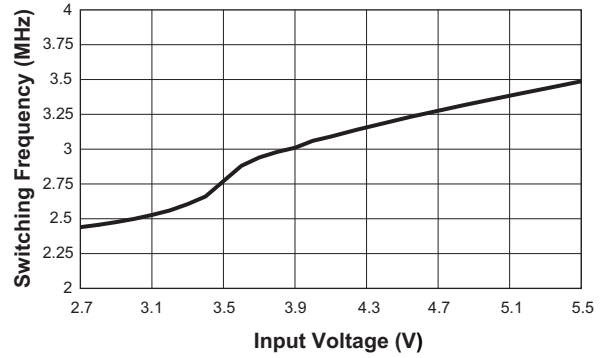

On-Time vs. Input Voltage (V_{OUT} = 1V; C_{IN} = C_{OUT} = 2.2µF; L = 1µH)

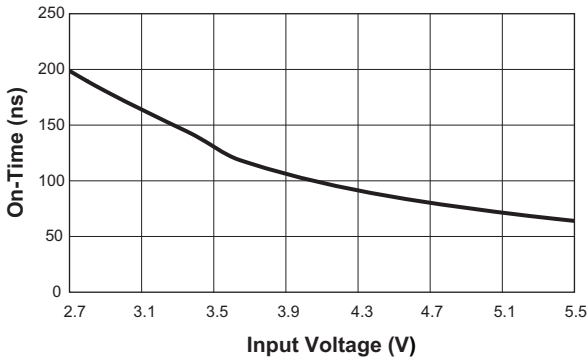

Switching Frequency vs. Input Voltage (V_{OUT} = 1.8V; C_{IN} = C_{OUT} = 2.2µF; L = 1.5µH)

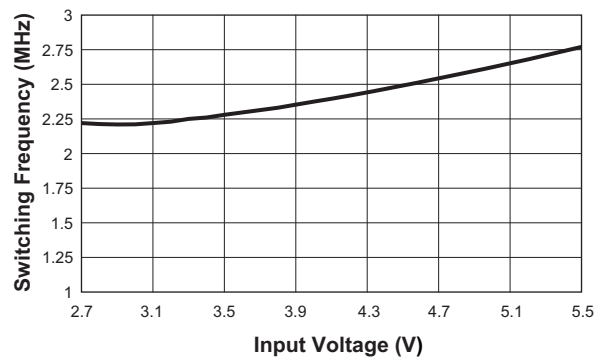

On-Time vs. Input Voltage (V_{OUT} = 1.8V; C_{IN} = C_{OUT} = 2.2µF; L = 1.5µH)

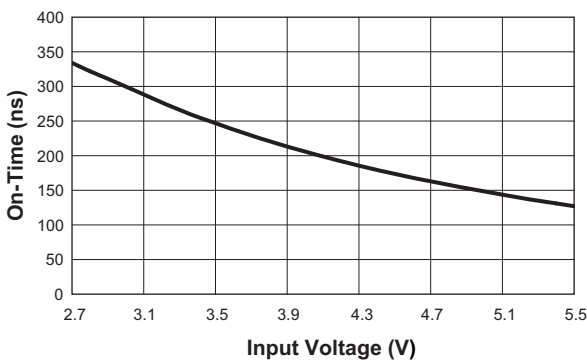

Switching Frequency Variation vs. Load Current

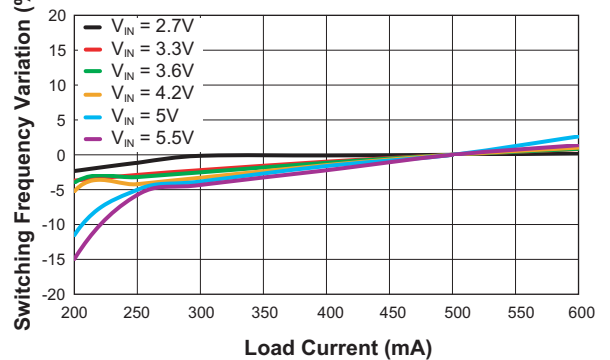

Typical Characteristics

Supply Current vs. Temperature

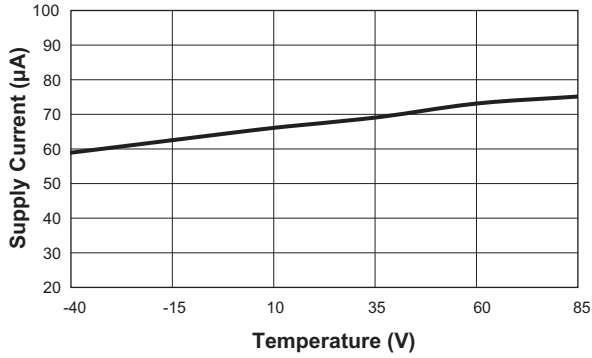

Output Voltage Error vs. Temperature

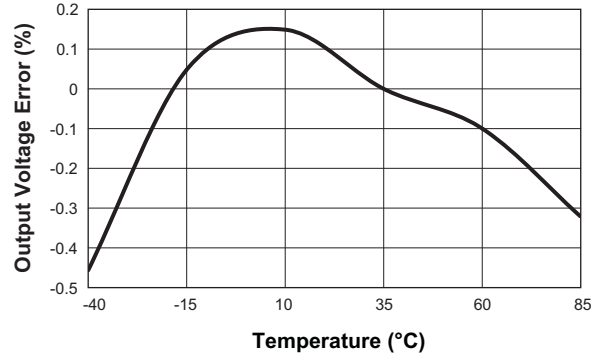

R_{DS(ON)} vs. Temperature

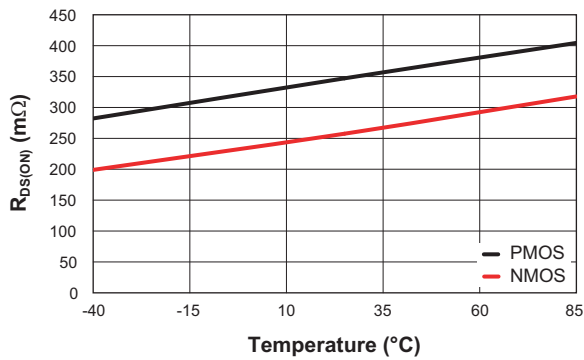

**Efficiency vs. Load Current
(V_{OUT} = 1.8V Fixed)**

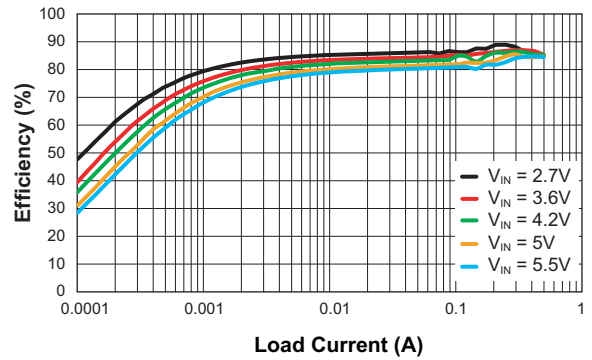

**Output Voltage Error vs. Load Current
(V_{OUT} = 1.8V Fixed)**

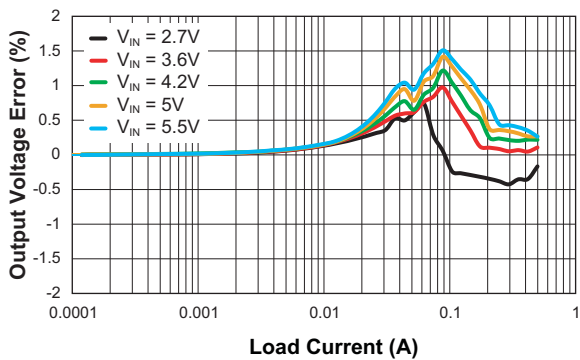

**Line Regulation
(V_{OUT} = 1.8V Fixed)**

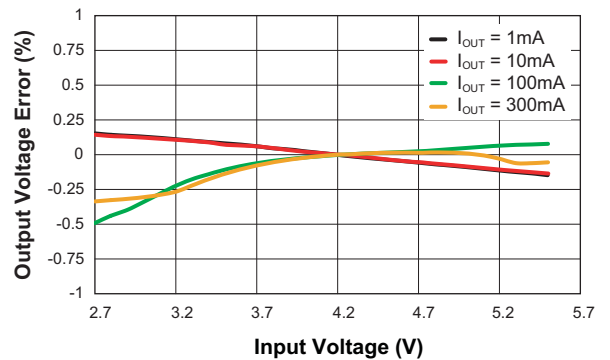

Typical Characteristics

Switching Frequency vs. Output Voltage
($I_{OUT} = 500mA$)

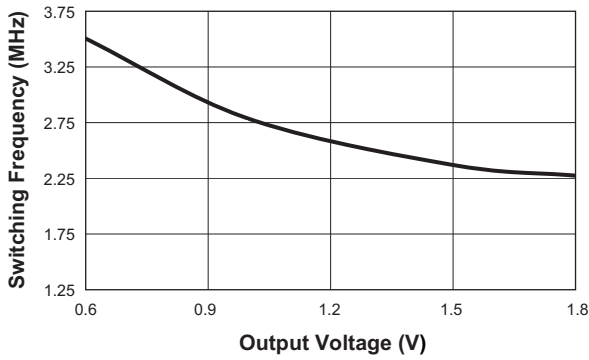

Load Transient

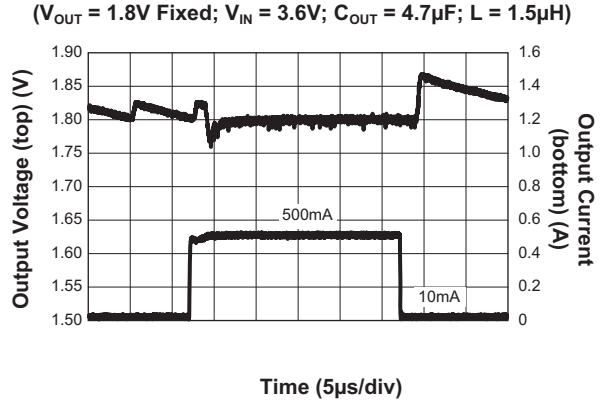

Load Transient

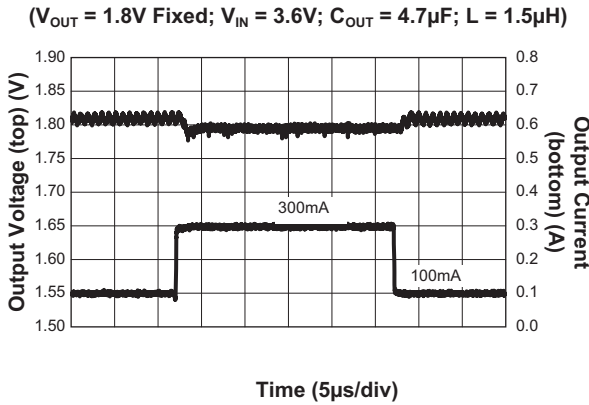

Load Transient

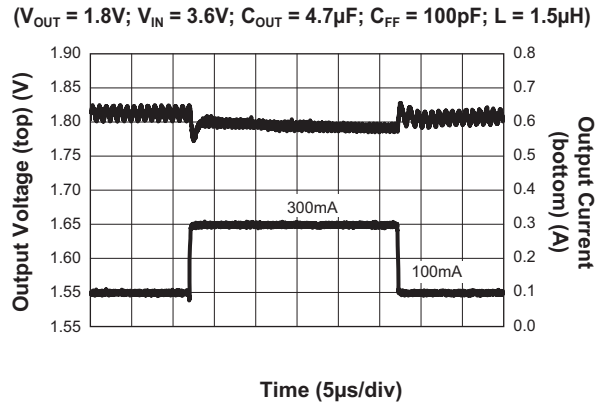

Load Transient

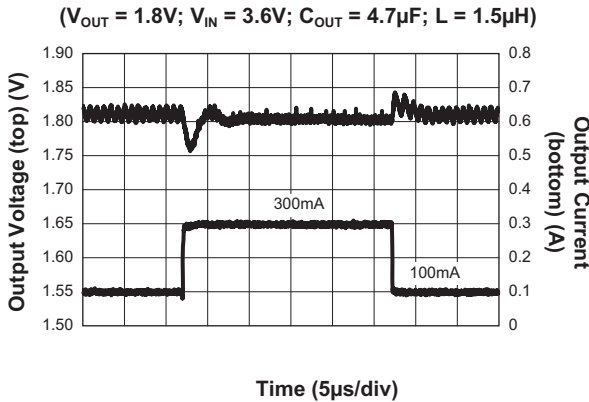

Load Transient

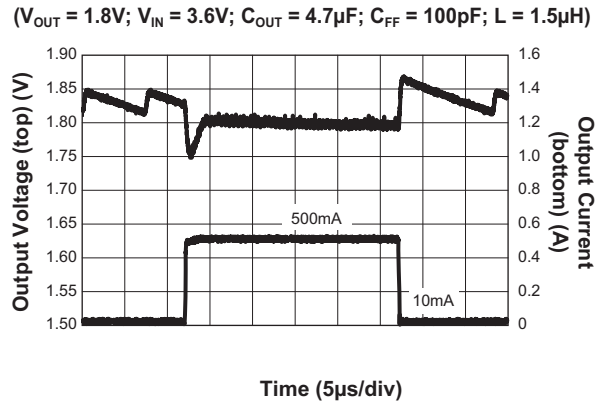

Typical Characteristics

Load Transient

($V_{OUT} = 1.8V$; $V_{IN} = 3.6V$; $C_{OUT} = 4.7\mu F$; $L = 1.5\mu H$)

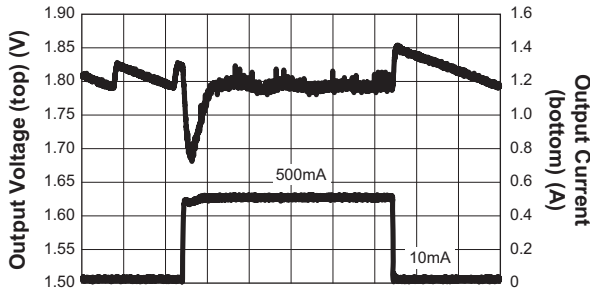

Time (5µs/div)

Load Transient

($V_{OUT} = 1.5V$; $V_{IN} = 3.6V$; $C_{OUT} = 4.7\mu F$; $C_{FF} = 100pF$; $L = 1.5\mu H$)

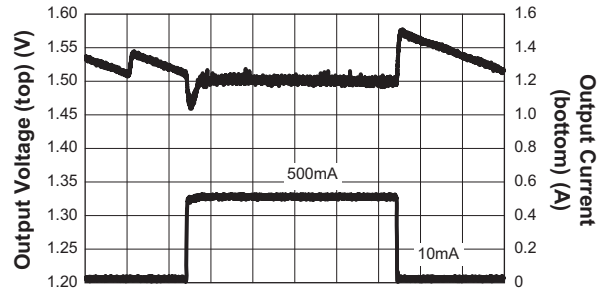

Time (5µs/div)

Load Transient

($V_{OUT} = 1.5V$; $V_{IN} = 3.6V$; $C_{OUT} = 4.7\mu F$; $L = 1.5\mu H$)

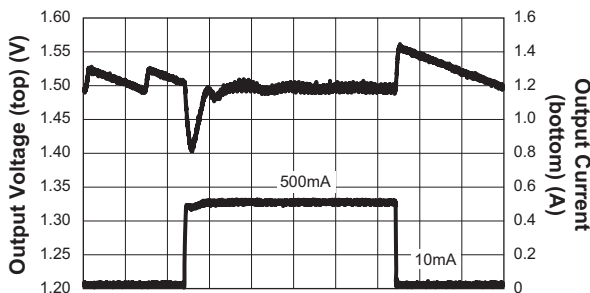

Time (5µs/div)

Load Transient

($V_{OUT} = 1.5V$; $V_{IN} = 3.6V$; $C_{OUT} = 4.7\mu F$; $C_{FF} = 100pF$; $L = 1.5\mu H$)

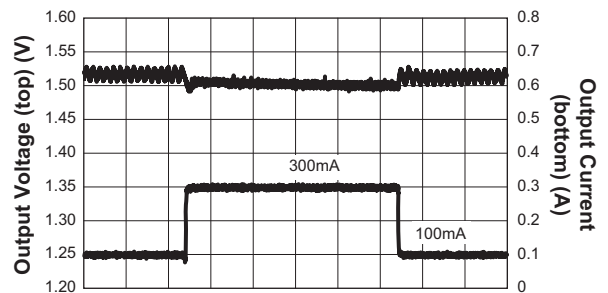

Time (5µs/div)

Load Transient

($V_{OUT} = 1.5V$; $V_{IN} = 3.6V$; $C_{OUT} = 4.7\mu F$; $L = 1.5\mu H$)

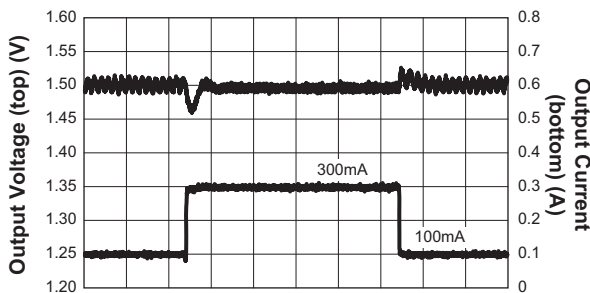

Time (5µs/div)

Load Transient

($V_{OUT} = 1V$; $V_{IN} = 3.6V$; $C_{OUT} = 4.7\mu F$; $C_{FF} = 100pF$; $L = 1\mu H$)

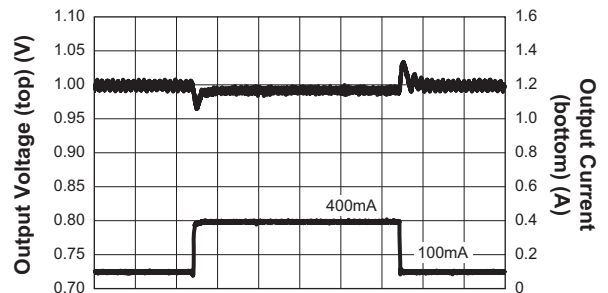

Time (5µs/div)

Typical Characteristics

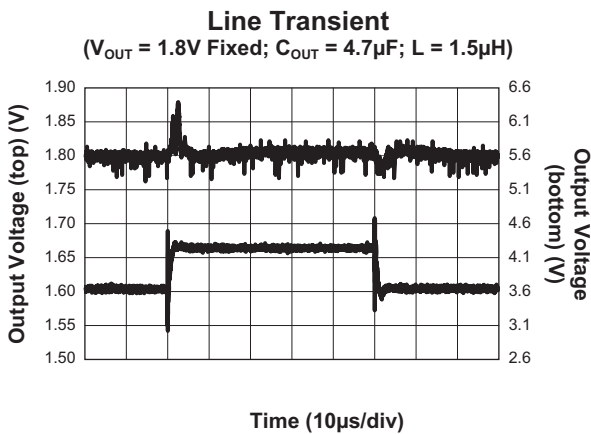
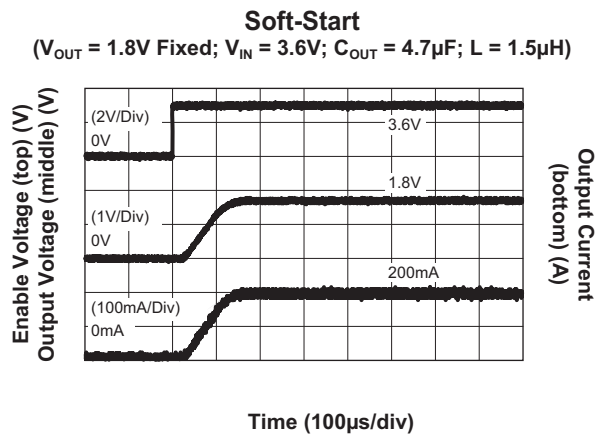
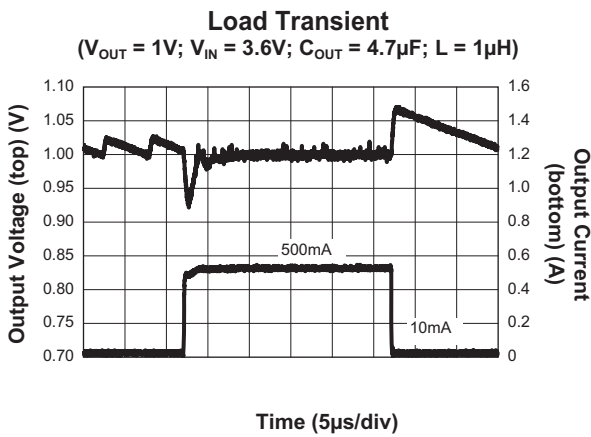
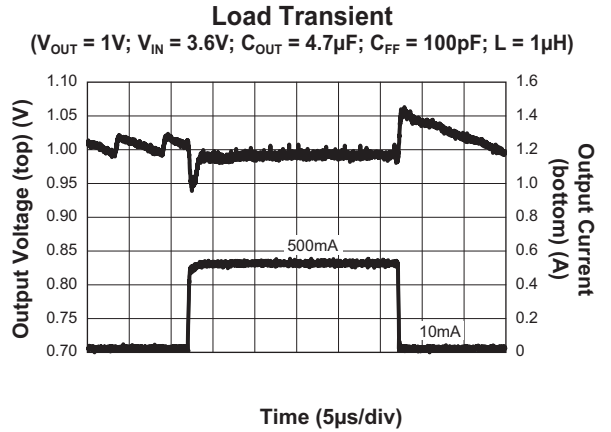
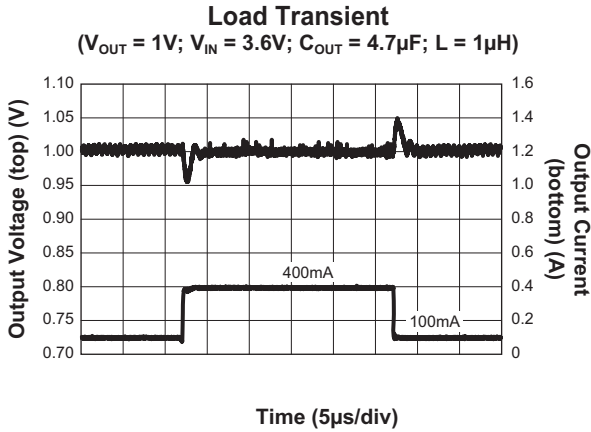

Functional Block Diagram

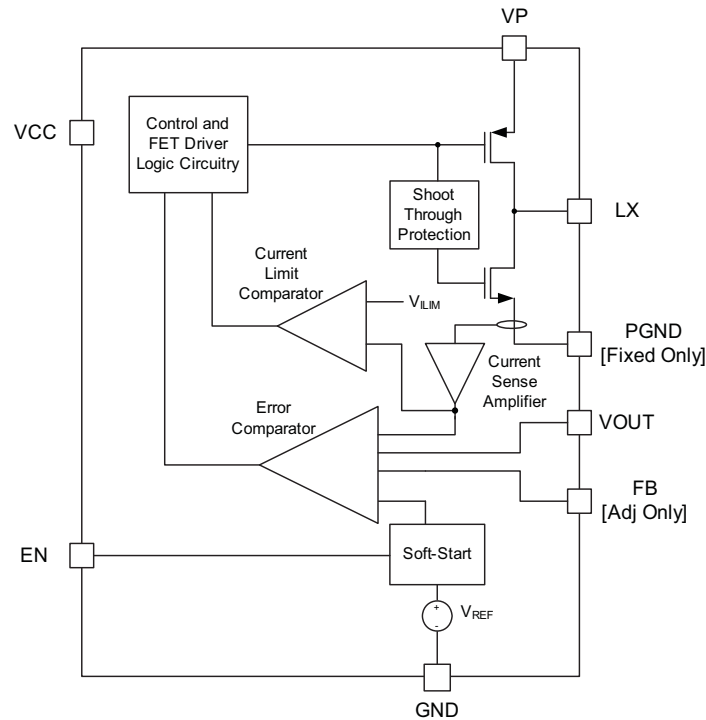

Functional Description

The AAT1130 is a high performance 500mA 2.5MHz (maximum switching frequency during steady-state operation) monolithic step-down converter. It minimizes external component size, enabling the use of a tiny 0603 inductor that is only 1mm tall, and optimizes efficiency over the complete load range. Apart from the small bypass input capacitor, only a small L-C filter is required at the output. Typically, a 1µH inductor and a 4.7µF ceramic capacitor are recommended for <1.2V output voltage applications (see table of values).

Only three external power components (C_{IN} , C_{OUT} , and L) are required, for fixed output voltage options. Output voltage is programmed with external feedback resistors, ranging from 0.6V to 1.8V. An additional feed-forward capacitor can also be added to the external feedback to provide improved transient response (see Figure 1).

The input voltage range is 2.7V to 5.5V. The converter efficiency has been optimized for all load conditions, ranging from no load to 500mA.

The internal error comparator and incorporated compensation provide excellent transient response, load, and line

regulation. Soft-start eliminates any output voltage overshoot when the enable or the input voltage is applied.

Control Loop

The AAT1130 uses a current-mode control scheme that allows it to operate at very high switching frequencies. The current-mode control scheme operates with a fixed on-time for a given input voltage. The on-time varies inversely proportional to the input voltage and proportional to the output voltage giving the regulator a fixed switching frequency when in steady-state. This allows the use of very small external inductor and capacitor. The small size coupled with the low quiescent current and automatic transition to variable switching frequency mode makes it ideal for small battery operated applications.

Light Load Operation

The AAT1130 monitors the synchronous rectifier current and when the current drops to zero, it turns off the synchronous rectifier to emulate an actual rectifier. This allows the regulator to operate in discontinuous conduc-

tion mode. In this mode the on-time remains the same as it is in continuous conduction mode, and therefore the inductor ripple current remains the same in both modes. But reduced load current requires more time for the output capacitor to discharge to the regulation voltage reducing the switching frequency. This has the added benefit of reducing the switching transition losses improving efficiency at light loads.

Stability

The AAT1130 requires no additional compensation components to guarantee stability. The only requirement for stability is to choose the appropriate output capacitor.

Current-mode control simplifies compensation by controlling the inductor current to regulate the output voltage. This approximates a single pole response in the loop gain even though a complex pole pair exists due to the LC filter. Therefore the crossover frequency is approximated as the DC loop gain multiplied by the single pole. The AAT1130 DC loop gain is a function of the 60mΩ current sense resistor and is determined by the equation:

$$A_{\text{LOOP(DC)}} = \frac{V_{\text{OUT}}}{0.6\text{V}} \cdot \frac{R_{\text{LOAD}}}{60\text{m}\Omega}$$

And the dominant pole frequency is:

$$f_p = \frac{1}{2\pi \cdot R_{\text{LOAD}} \cdot C_{\text{OUT}}}$$

Therefore the crossover frequency is:

$$\begin{aligned} f_c &= A_{\text{LOOP(DC)}} \cdot f_p \\ &= \frac{V_{\text{OUT}}}{2\pi \cdot 0.6\text{V} \cdot 60\text{m}\Omega \cdot C_{\text{OUT}}} \end{aligned}$$

The only requirement for stability is that the crossover frequency be much less than the 2.5MHz switching frequency. The crossover frequency can be as high as 1/2 of the switching frequency, or 1.25MHz. Therefore calculate the output capacitor by the equation:

$$C_{\text{OUT}} > \frac{V_{\text{OUT}}}{2\pi \cdot 0.6\text{V} \cdot 60\text{m}\Omega \cdot 1.25\text{MHz}}$$

Example:

Given that $V_{\text{OUT}} = 1.2\text{V}$, then $C_{\text{OUT}} > 4.24\mu\text{F}$, therefore a 4.7μF capacitor is suitable.

Due to the unique control method, the “inside” current control loop does not have the inherent instability that plagues most fixed frequency current-mode DC-DC regulators.

Soft-Start

When the AAT1130 is enabled, it enters soft-start mode. In this mode, the output voltage slowly rises over 150μs allowing the output capacitor to charge without drawing excessive input current. This feature prevents over-stressing the battery or other input power source.

Current Limit

The AAT1130 includes a cycle-by-cycle current limit to prevent damage to itself and external circuitry. The current limit is a valley current limit using the n-channel synchronous rectifier to measure the current. If the synchronous rectifier current is above the valley current limit, the AAT1130 holds the synchronous rectifier on until the current is below the limit. This allows the AAT1130 to control the current in current limit even with a hard shorted output.

Anti-Ringing Switch

The AAT1130 includes an anti-ringing switch that dissipates any energy left in the inductor when the current is approximately zero. The anti-ringing switch turns on when both the p-channel switch and n-channel synchronous rectifier are off and the inductor current is approximately zero. The switch shorts the LX and VOUT nodes together, effectively shorting the inductor. The low on-resistance of the anti-ringing switch dissipates any energy left in the inductor preventing ringing at light loads. When either the switch or synchronous rectifier are on, the anti-ringing switch remains off.

Over-Temperature

The AAT1130 includes thermal protection that automatically turns off the regulator when the die temperature exceeds a safe level. The thermal protection turns on at a die temperature of 140°C and has a 15°C hysteresis.

Applications Information

Inductor Selection

The step-down converter uses valley current mode control with slope compensation to maintain stability for duty cycles greater than 50%. The output inductor value must be selected so the inductor current down slope meets the internal slope compensation requirements. Table 1 displays suggested inductor values for various output voltages.

Manufacturer's specifications list both the inductor DC current rating, which is a thermal limitation, and the peak current rating, which is determined by the saturation characteristics. The inductor should not show any appreciable saturation under normal load conditions. Some inductors may meet the peak and average current ratings yet result in excessive losses due to a high DCR. Always consider the losses associated with the DCR and its effect on the total converter efficiency when selecting an inductor. See Table 3 for suggested inductor values and vendors.

Configuration	Output Voltage	Inductor Value
Adjustable and Fixed Output Voltage	1V, 1.2V, 1.3V	1.0 μ H to 1.5 μ H
	1.5V, 1.8V	1.5 μ H to 2.2 μ H

Table 1: Inductor Values for Specific Output Voltages.

Input Capacitor

Select a 4.7 μ F to 10 μ F X7R or X5R ceramic capacitor for the input. Always examine the ceramic capacitor DC voltage coefficient characteristics when selecting the proper value. For example, the capacitance of a 10 μ F, 6.3V, X5R ceramic capacitor with 5.0V DC applied is actually about 6 μ F.

The input capacitor provides a low impedance loop for the edges of pulsed current drawn by the AAT1130. Low ESR/ESL X7R and X5R ceramic capacitors are ideal for this function. To minimize stray inductance, the capacitor should be placed as closely as possible to the IC. This keeps the high frequency content of the input current localized, minimizing EMI and input voltage ripple.

The proper placement of the input capacitor (C1) can be seen in the evaluation board layouts in Figures 4, 5, 6, and 7.

A laboratory test set-up typically consists of two long wires running from the bench power supply to the evaluation board input voltage pins. The inductance of these wires, along with the low-ESR ceramic input capacitor, can create a high Q network that may affect converter performance. This problem often becomes apparent in the form of excessive ringing in the output voltage during load transients. Errors in the loop phase and gain measurements can also result.

Since the inductance of a short PCB trace feeding the input voltage is significantly lower than the power leads from the bench power supply, most applications do not exhibit this problem. In applications where the input power source lead inductance cannot be reduced to a level that does not affect the converter performance, a high ESR tantalum or aluminum electrolytic should be placed in parallel with the low ESR, ESL bypass ceramic. This dampens the high Q network and stabilizes the system.

Output Capacitor

The output capacitor limits the output ripple and provides holdup during large load transitions. A 4.7 μ F to 10 μ F X5R or X7R ceramic capacitor typically provides sufficient bulk capacitance to stabilize the output during large load transitions and has the ESR and ESL characteristics necessary for low output ripple.

The internal voltage loop compensation also limits the minimum output capacitor value to 4.7 μ F. This is due to its effect on the loop crossover frequency (bandwidth), phase margin, and gain margin. Increased output capacitance will reduce the crossover frequency with greater phase margin.

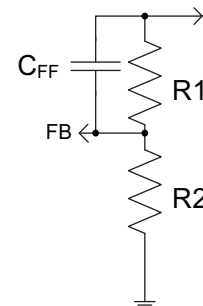

Figure 1: AAT1130 External Resistor Output Voltage Programming.

Feedback Resistor Selection

Resistors R1 and R2 of Figure 4 program the output to regulate at a voltage higher than 0.6V. To limit the bias current required for the external feedback resistor string while maintaining good noise immunity, the minimum suggested value for R2 is 59kΩ. Although a larger value will further reduce quiescent current, it will also increase the impedance of the feedback node, making it more sensitive to external noise and interference. Table 2 summarizes the resistor values for various output voltages with R2 set to either 59kΩ for good noise immunity or 221kΩ for reduced no load input current.

$$R1 = \left(\frac{V_{OUT}}{V_{FB}} - 1 \right) \cdot R2 = \left(\frac{1.5V}{0.6V} - 1 \right) \cdot 59k\Omega = 88.5k\Omega$$

The AAT1130, combined with an external feedforward capacitor (C3 in Figure 4), delivers enhanced transient response for extreme pulsed load applications. The addition of the feedforward capacitor typically requires a larger output capacitor C1 for stability.

V _{OUT} (V)	R2 = 59kΩ R1 (kΩ)	R2 = 221kΩ R1 (kΩ)
0.9	29.4	113
1	39.2	150
1.1	49.9	187
1.2	59.0	221
1.3	68.1	261
1.4	78.7	301
1.5	88.7	332
1.8	118	442

Table 2: Feedback Resistor Values.

Thermal Calculations

There are three types of losses associated with the AAT1130 step-down converter: switching losses, conduction losses, and quiescent current losses. Conduction losses are associated with the R_{DS(ON)} characteristics of the power output switching devices. Switching losses are dominated by the gate charge of the power output switching devices. At full load, assuming continuous conduction mode (CCM), a simplified form of the losses is given by:

$$P_{TOTAL} = \frac{I_O^2 \cdot (R_{DS(ON)H} \cdot V_O + R_{DS(ON)L} \cdot [V_{IN} - V_O])}{V_{IN}} + (t_{sw} \cdot F_S \cdot I_O + I_Q) \cdot V_{IN}$$

I_Q is the step-down converter quiescent current. The term t_{sw} is used to estimate the full load step-down converter switching losses. For the condition where the step-down converter is in dropout at 100% duty cycle, the total device dissipation reduces to:

$$P_{TOTAL} = I_O^2 \cdot R_{DS(ON)H} + I_Q \cdot V_{IN}$$

Since R_{DS(ON)}, quiescent current, and switching losses all vary with input voltage, the total losses should be investigated over the complete input voltage range. Given the total losses, the maximum junction temperature can be derived from the θ_{JA} for the SC70JW-10 package which is 160°C/W.

$$T_{J(MAX)} = P_{TOTAL} \cdot \theta_{JA} + T_{AMB}$$

Layout

The suggested PCB layout for the AAT1130 is shown in Figures 1, 2, and 3. The following guidelines should be used to help ensure a proper layout:

1. The input capacitor (C1) should connect as closely as possible to VCC/VP (pins 3 and 4) and PGND/GND (pins 7-10 for adjustable output voltage and pins 6-10 for fixed output voltage).
2. C1 and L1 should be connected as closely as possible. The connection of L1 to the LX (pin 5) should be as short as possible.
3. The feedback trace or FB (pin 1 for adjustable output voltage) should be separate from any power trace and connect as closely as possible to the load point. Sensing along a high current load trace will degrade DC load regulation. If external feedback resistors are used, they should be placed as closely as possible to the FB (pin 1 for adjustable output voltage) to minimize the length of the high impedance feedback trace.
4. The resistance of the trace from the load return to the PGND/GND (pins 7-10 for adjustable output voltage and pins 6-10 for fixed output voltage) should be kept to a minimum. This will help to minimize any error in DC regulation due to differences in the potential of the internal signal ground and the power ground.

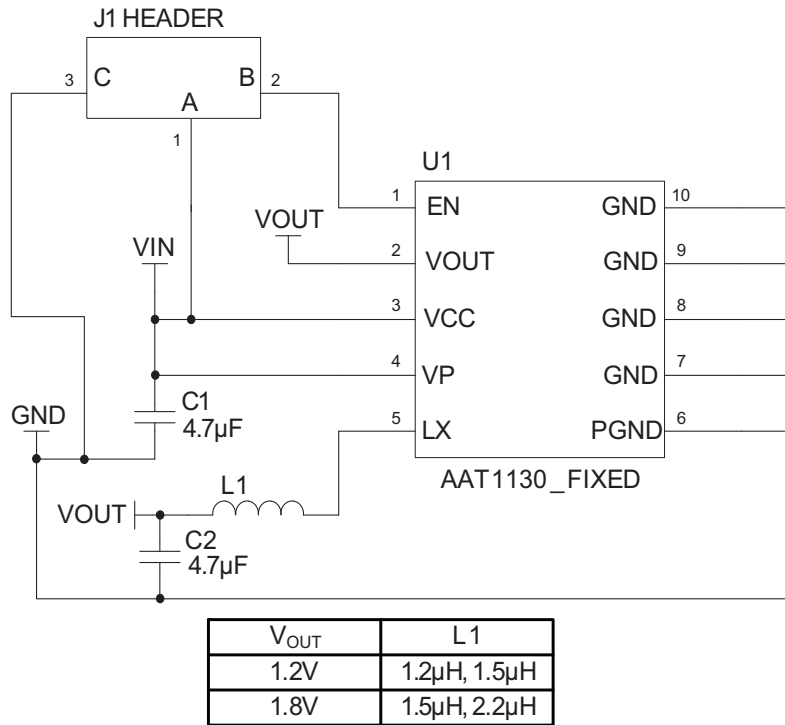

Figure 2: AAT1130 Fixed Output Voltage Evaluation Board Schematic.

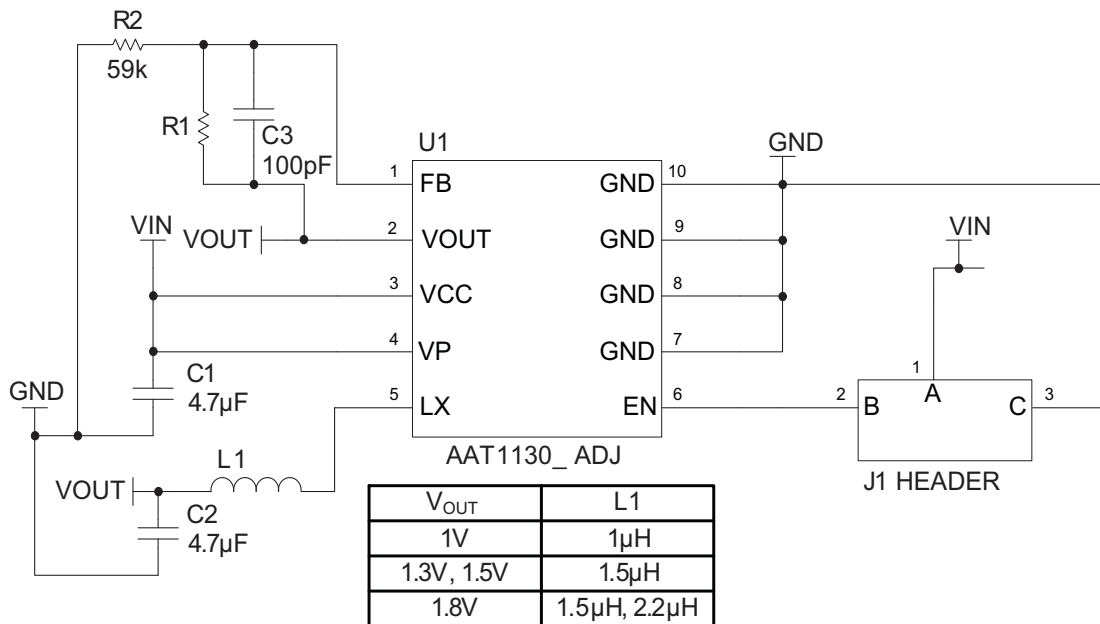

Figure 3: AAT1130 Adjustable Output Voltage Evaluation Board Schematic.

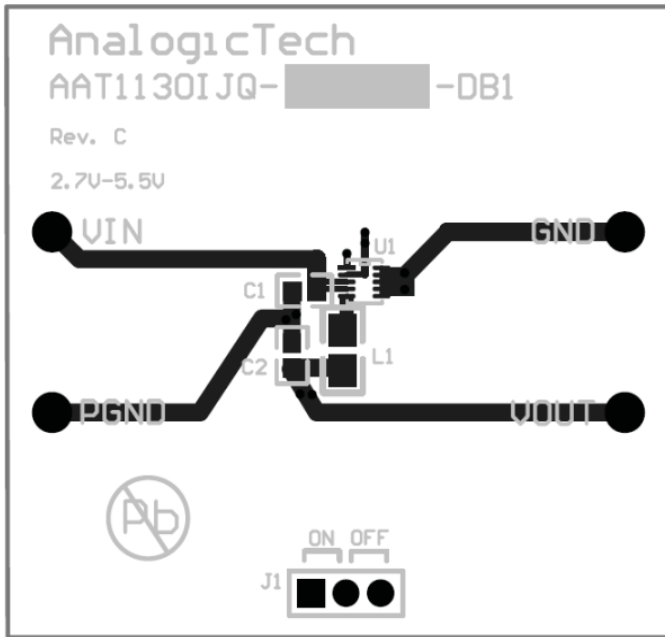

Figure 4: AAT1130 Fixed Output Voltage Evaluation Board Top Side PCB Layout.

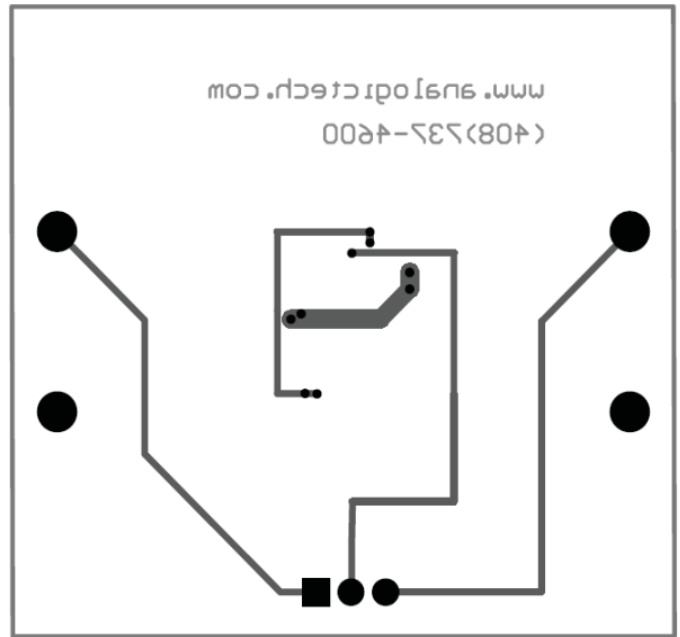

Figure 5: AAT1130 Fixed Output Voltage Evaluation Board Bottom Side PCB Layout.

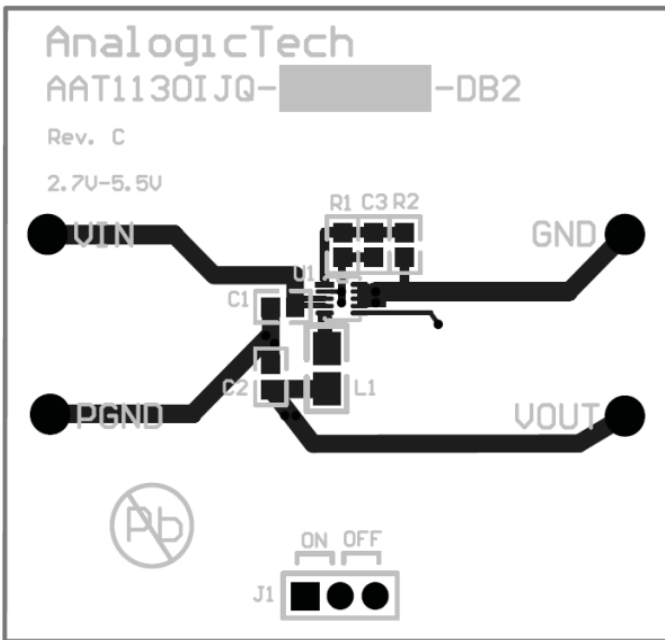

Figure 6: AAT1130 Adjustable Output Voltage Evaluation Board Top Side PCB Layout.

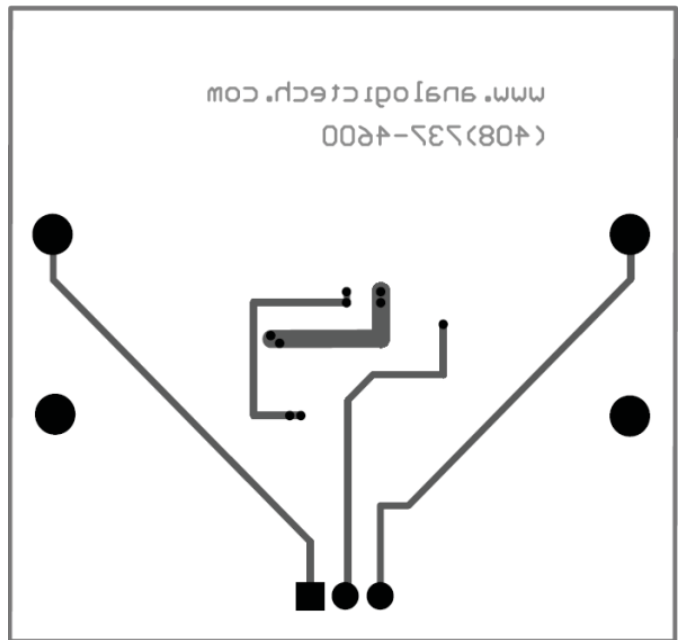

Figure 7: AAT1130 Adjustable Output Voltage Evaluation Board Bottom Side PCB Layout.

Manufacturer	Part Number/Type	Inductance (μH)	Rated Current (mA)	DCR (mΩ) (typ)	Size (mm) LxWxH
Murata	LQM2HP_G0	1	1600	55	2.5x2x1
		1.5	1500	70	
		2.2	1300	80	
	LQH32P_N0	1	2050	45	3.2x2.5x1.6
		1.5	1750	57	
		2.2	1600	76	
TDK	GLC2518	1	2.8	20	2.5x1.8x1.8
		2.2	2.45	25	
	VLF3010A	1.5	1200	68	2.8x2.6x1
		2.2	1000	100	
	VLF3010S	1	1700	41	3.0x2.8x1
		2.2	1100	77	

Table 3: Suggested Inductor Components.

Manufacturer	Part Number	Value	Voltage	Temp. Co.	Case
AVX	0603ZD225K	2.2μF	10	X5R	0603
TDK	C1608X5R1C225K	2.2μF	16	X5R	0603
	C1608X5R1A475K	4.7μF	10		
	C2012X5R1A106K	10μF	10		0805
	C3216X5R1A226K	22μF	10		
Murata	GRM188R61A225K	2.2μF	10	X5R	0603
	GRM219R61A106K	10μF	10		0805
	GRM31CR71A226K	22μF	10		X7R
Taiyo Yuden	LMK107BJ475KA	4.7μF	10	X5R	0603

Table 4: Suggested Capacitor Components.

Ordering Information

Output Voltage	Package	Marking ¹	Part Number (Tape and Reel) ²
Adjustable	SC70JW-10	2VXXY	AAT1130IJQ-0.6
1.8V	SC70JW-10	2UXXY	AAT1130IJQ-1.8



All AnalogicTech products are offered in Pb-free packaging. The term "Pb-free" means semiconductor products that are in compliance with current RoHS standards, including the requirement that lead not exceed 0.1% by weight in homogeneous materials. For more information, please visit our website at <http://www.analogictech.com/about/quality.aspx>.

1. XYY = assembly and date code.

2. Sample stock is generally held on part numbers listed in **BOLD**.

Package Information

SC70JW-10

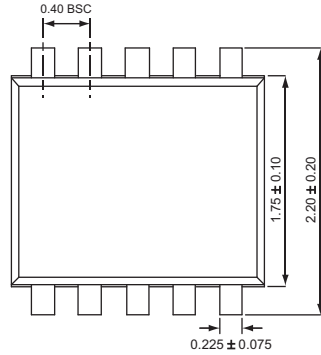

Top View

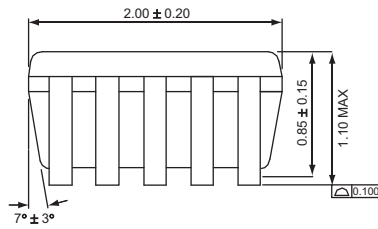

Side View

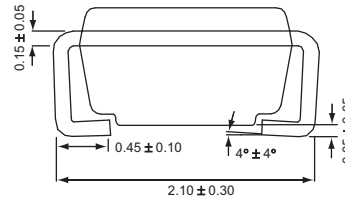

End View

All dimensions in millimeters.

Advanced Analogic Technologies, Inc.
3230 Scott Boulevard, Santa Clara, CA 95054
Phone (408) 737-4600
Fax (408) 737-4611



© Advanced Analogic Technologies, Inc. AnalogicTech cannot assume responsibility for use of any circuitry other than circuitry entirely embodied in an AnalogicTech product. No circuit patent licenses, copyrights, mask work rights, or other intellectual property rights are implied. AnalogicTech reserves the right to make changes to their products or specifications or to discontinue any product or service without notice. Except as provided in AnalogicTech's terms and conditions of sale, AnalogicTech assumes no liability whatsoever, and AnalogicTech disclaims any express or implied warranty relating to the sale and/or use of AnalogicTech products including liability or warranties relating to fitness for a particular purpose, merchantability, or infringement of any patent, copyright or other intellectual property right. In order to minimize risks associated with the customer's applications, adequate design and operating safeguards must be provided by the customer to minimize inherent or procedural hazards. Testing and other quality control techniques are utilized to the extent AnalogicTech deems necessary to support this warranty. Specific testing of all parameters of each device is not necessarily performed. AnalogicTech and the AnalogicTech logo are trademarks of Advanced Analogic Technologies Incorporated. All other brand and product names appearing in this document are registered trademarks or trademarks of their respective holders.