

REVISION RECORD

REV	ECN	DESCRIPTION	DRFT	DATE
-----	-----	-------------	------	------

NOTES1:

UL Standard

- 1.Rated voltage/current : 300V / 8A
- 2.Withstanding voltage : AC1600V/1Min.

IEC Standard

1. Pollution Degree	2
Overvoltage Category	II
Rate Impulse Voltage(KV)	2.5KV
Rate Voltage(V)	250V
Rate Current(A)	7A

NOTES2:

- 1.Dimension shall be interpreted per ASME Y14.5-2009
- 2.Pitch : 3.5/3.81mm, Poles : N=02~22P
- 3.Operating temperature: -40°C~+105°C
- 4.Undimensioned tolerances:

Pitch range in mm	Nominal dimension range in mm							0.1/10	
	Over 6 TO 6	Over 10 TO 10	Over 10 TO 24	Over 30 TO 30	Over 60 TO 100	Over 100 TO 150	Over 150 TO 150		
	±0.15	±0.20	±0.30	±0.30	±0.50	±0.70	±1.00	±1.30	±2*

5.RoHS Compliance

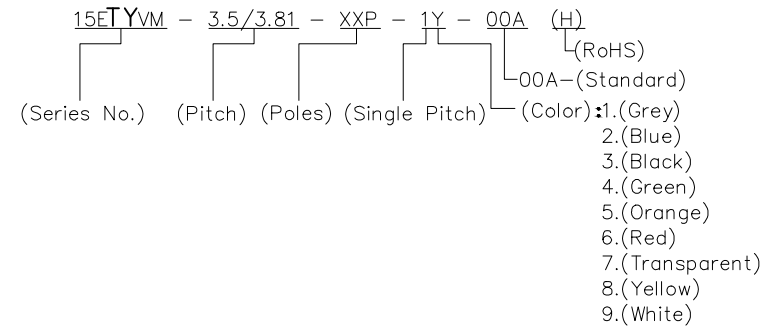
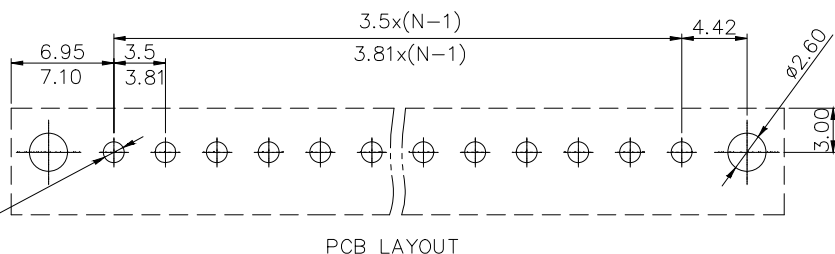
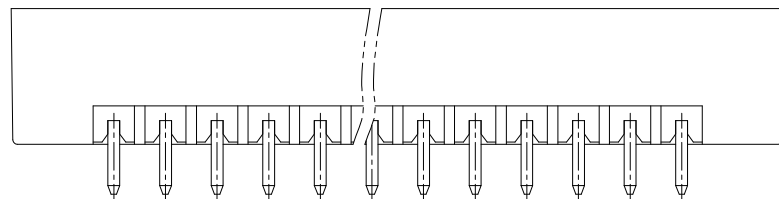
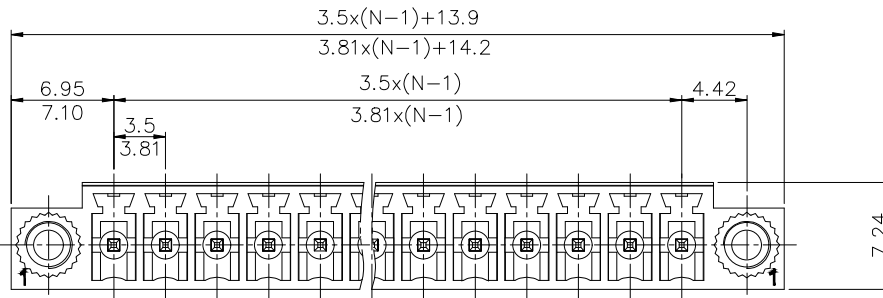
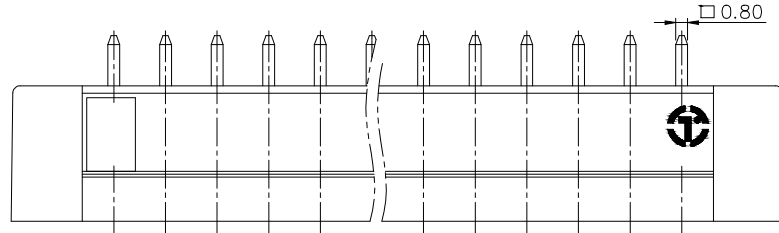
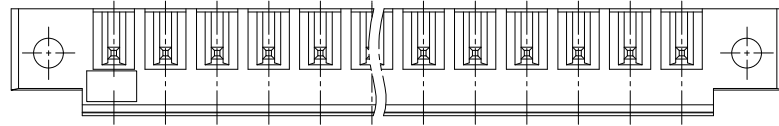
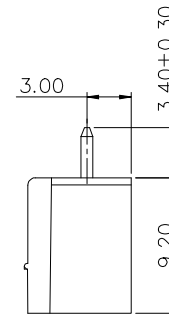

DETACHED LISTS	PART NO.:	拓宜 (上海) 工控电器设备有限公司		
	APPD:	NAME: 15E T Y V M - 3.5 / 3.81 - X X P - 1 Y - 0 0 A (H)		
	CHKD:	TITLE: CUSTOMER DRAWING		
	DRFT:	REV	DO	
THIRD ANGLE PROJECTION		DRAWING NO.:	SHEET	1/1
		MM (INCH)	DO NOT SCALE DRAWING	SCALE 1:1