



LED-75W Series– Fixed Output and Dimmable Switch Mode LED Drivers Constant Current & Constant Voltage with Isolation Black Magic Thermal Advantage™ Aluminum Housing

Electrical Specifications

Input Voltage Range:	100-277 Vac Nom. (90-305 V Min/Max)
Input Over-Voltage:	Can endure 320Vac for 48 Hrs, 350Vac for 2 Hrs
Frequency:	50/60 Hz Nom. (47-63 Hz Min/Max)
Power Factor:	>0.90 @ full load, 100V through 277V
Inrush Current:	<30.0 Amps max @ 230 Vac, cold start 25°C
Input Current:	1.00 Amps max
Maximum Power:	75W
Current Accuracy:	± 1% Over input line variation
Load Regulation:	± 3%
THD:	≤ 20% @ full load
Leakage Current:	400 µA Typical
Hold Up Time:	Half Cycle
Protection:	Output Over-Voltage, Output Over-Current, and Output Short Circuit Protection reset by power cycling

Environmental Specifications

Minimum Starting Temp:	-30°C
Maximum Case Temp.	90°C
Storage Temperature:	-40°C to +85°C
Humidity:	5% to 95%
Cooling:	Convection
Vibration Frequency:	5 to 55 Hz/2g, 30 minutes
Sound Rating:	Class A
MTBF:	478,000 Hours at full load and 40°C ambient conditions per MIL-217F Notice 2
EMC:	FCC 47CFR Part 15 Class B compliant



- Total Power: 75 Watts
- Input Voltage: 100-277 Vac Nom.
- UL Dry & Damp Location Rated
- IP66
- High Power Factor
- UL8750, CSA 22.2, EN61347, EN61000-3-2, EN61000-3-3 Class C

Constant Current - Product Specifications

Model Number	Output Current (mA ±3%)	Output Voltage Range (Vdc)	Max. Output Power (W)	Typical Efficiency
LED75W-257-C0300-XX	300	85-257	75	91%
LED75W-200-C0350-XX	350	66-200	70	91%
LED75W-128-C0600-XX	600	42-128	75	91%
LED75W-085-C0900-XX	900	28-85	75	90%
LED75W-064-C1200-XX	1200	21-64	75	90%
LED75W-056-C1400-XX	1400	18-56	75	90%
LED75W-048-C1600-XX	1600	16-48	75	90%
LED75W-036-C2100-XX	2100	12-36	75	89%
LED75W-030-C2500-XX	2500	10-30	75	89%
LED75W-027-C2800-XX	2800	9-27	75	88%
LED75W-025-C3000-XX	3000	8-25	75	88%
LED75W-022-C3400-XX	3400	7-22	74.8	88%
LED75W-020-C3750-XX	3750	7-20	75	87%
LED75W-018-C4200-XX	4200	6-18	75	86%
LED75W-015-C5000-XX	5000	5-15	75	86%

-XX indicates dimming options are available. See options at left. Blank = fixed current output

Constant Voltage - Product Specifications

Model Number	Output Voltage (Vdc ±5%)	Output Current Range (mA)	Max. Output Power (W)	Typical Efficiency
LED75W-015	15	1250-5000	75	86%
LED75W-018	18	1050-4200	75	86%
LED75W-020	20	938-3750	75	87%
LED75W-022	22	850-3400	74.8	88%
LED75W-025	25	750-3000	75	88%
LED75W-027	27	700-2800	75	88%
LED75W-030	30	625-2500	75	89%
LED75W-036	36	525-2100	75	89%
LED75W-048	48	400-1600	75	90%
LED75W-056	56	350-1400	75	90%
LED75W-064	64	300-1200	75	90%
LED75W-085	85	225-900	75	90%
LED75W-128	128	150-600	75	91%
LED75W-200	200	88-350	70	91%
LED75W-257	257	75-300	75	91%

Class 2: US/Canada US Only

Ordering Options:

- D: 0-10V & Resistance dimmable version comes with an extra two wires +Purple/-Gray on the output side. -D 0-10V Dimming is compatible with most quality 0-10V wall dimmers. See page 3 for additional specifications.
- PD: PWM Dimmable version comes with an extra two wires +Purple/-Gray on the output side. PD PWM version is PWM Dimmable via a positive 10% to 100% Duty Cycle, 200Hz to 1KHz, 0-10V Pulse. See page 4 for additional specifications.



Note:
LED drivers are designed and intended to operate LED loads only. Non-LED loading may be outside the specified design limits of our LED drivers, and therefore cannot be covered by any warranty. If you desire to use our LED drivers to operate non-LED loads please contact us to discuss compatibility.

Specifications subject to change without notice.

Rev 8-31-15

Dimensions - mm

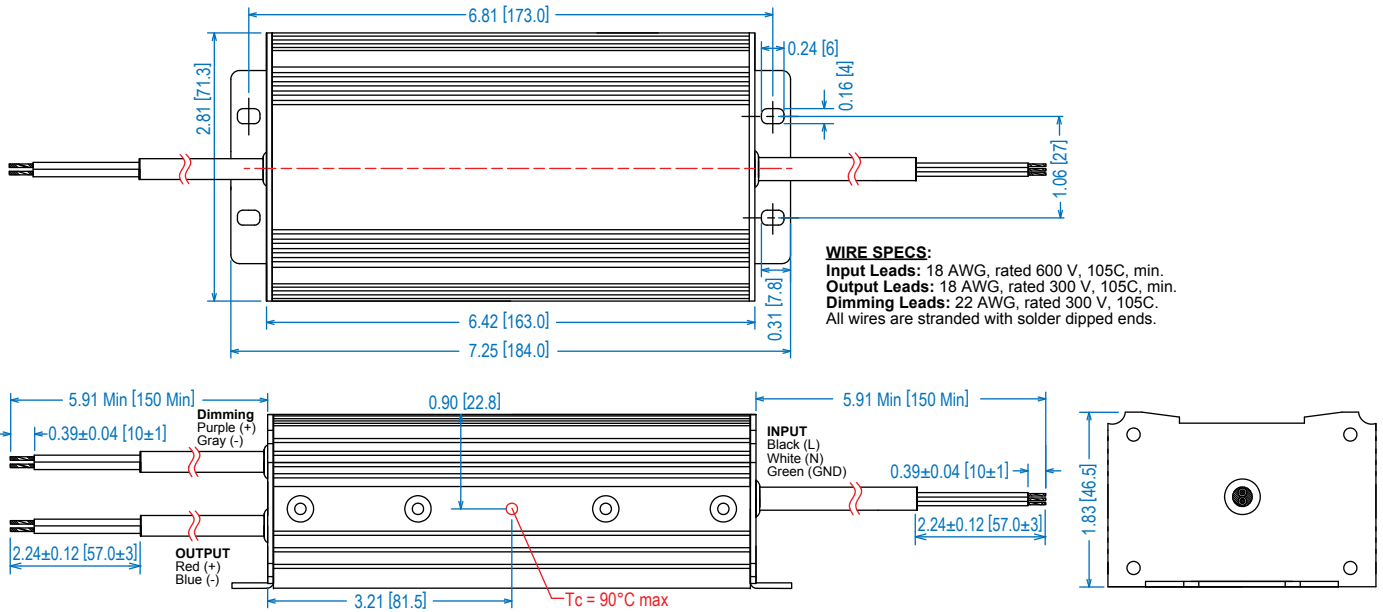

Power Factor / Load

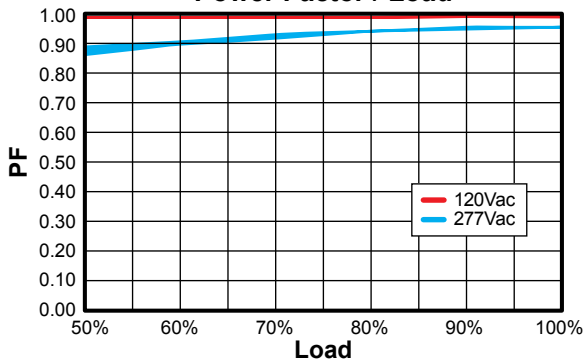

THD / Load

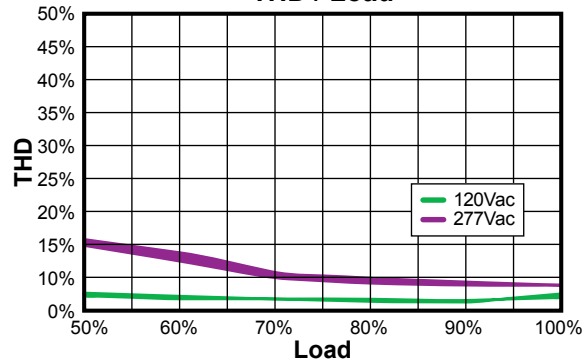

Lifetime / Case Temperature (Full Load @ 120Vac)

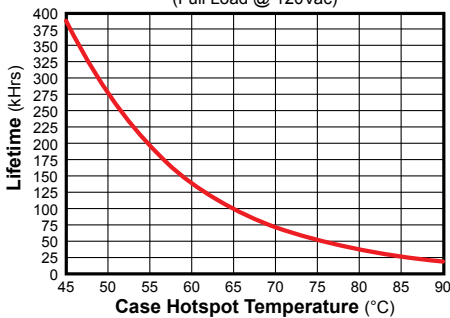

Note:
 Life calculations are based on reliability with confidence using a 90% confidence level and <5% failure rate. At a confidence level of 90% it is expected that <5% of the parts will fail at the rated life provided. (Failure is defined as a driver drifting outside specification, rather than fail to operate)

UL Conditions of Acceptability

See website for additional information

“-D” Option: 0-10VDC and Resistance Dimming

Parameters	Minimum	Typical	Maximum
Source Current out of 0-10V Purple Wire	0 mA	—	2 mA
Absolute Voltage Range on 0-10V (+) Purple Wire	-2.0 V	—	+15 V

Typical Dimming Circuit

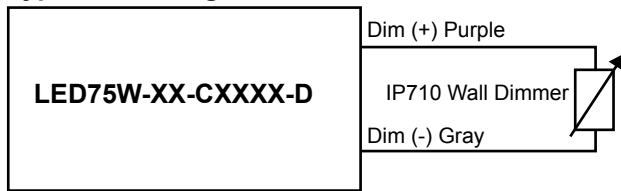

(Dimmer must be current-sink type control)

Output Current / 0-10VDC Dimming Input

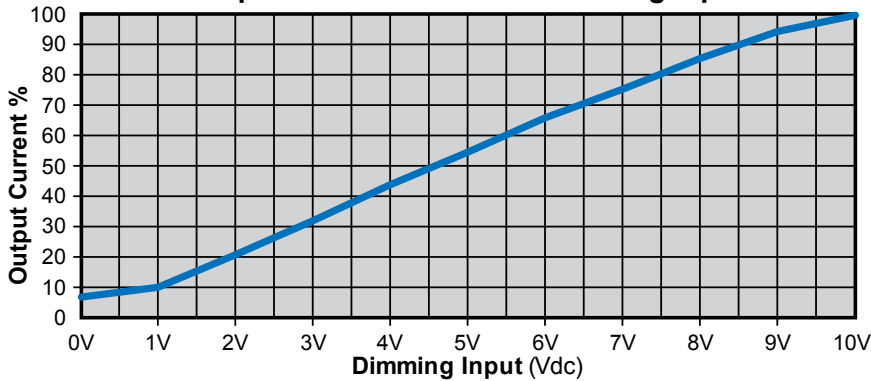

Notes:

1. 0-10V dimmable version comes with an extra two wires +Purple/-Gray on the output side.
2. Compatible with most 0-10V Wall Slide dimmers and direct 0-10V analog signal. Recommended dimmer is Leviton IP710 or equivalent
3. 0-10V dimmable version is not intended to dim below about 5% @ 0V or 10% @ 1.0V
4. 0-10V dimmable version output will be 100% with Purple/Gray open and minimum with Purple/Gray Shorted.

“-PD” Option: PWM Dimming

Parameters	Minimum	Typical	Maximum
Absolute Maximum Voltage Range on PWM Input (Purple Wire)	-2.0V	10V	+28V
Input LOW Level Voltage Range (Purple Wire)	-2.0	0V	+7.5V
Input HIGH Level Voltage Range (Purple Wire)	+9.0	10V	28V
Sink Current into PWM Input (Purple Wire)	0mA	—	1.2mA
PWM Input Signal Frequency	200Hz	—	1000Hz
PWM Input Signal Positive Duty Cycle	0%	10-90%	100%

PWM Positive Dimming Typical Circuit

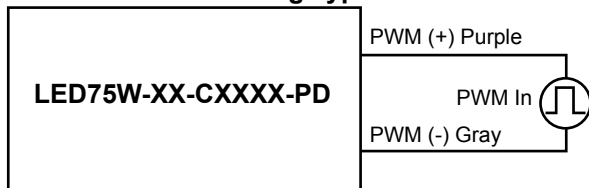

Output Current / Positive Duty Cycle

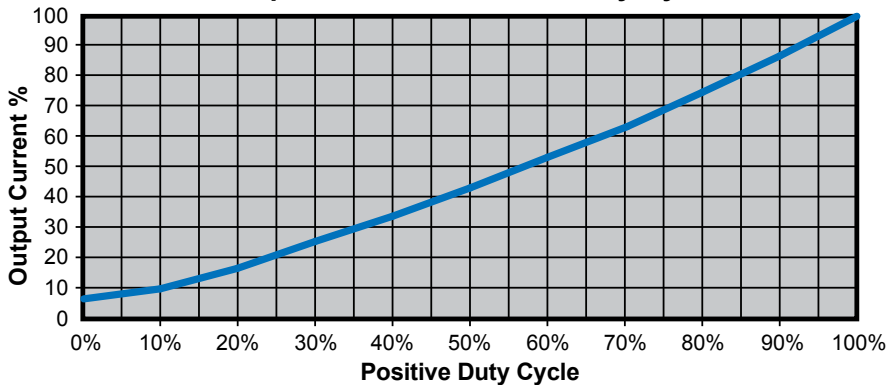

Notes:

1. PWM Dimmable version comes with an extra 2 wires +Purple/-Gray on the output side.
2. Below 10% Duty cycle proper dimming operation is not assured. Unit is not intended to turn off at <10% Duty Cycle.
3. PWM dimmable version output will be 100% with Purple/Gray open and minimum with Purple/Gray Shorted.