

Bullet Type LED lamp

BL-L524

Features:

- Ø 5mm Round-Helmet Type LED Lamp
- Ø Ultra brightness.
- Ø Choice of various viewing angles.
- Ø Diffused, Transparent and Water clear lens are available.
- Ø IC compatible /Low current capability.
- Ø RoHs Compliance



Electrical-optical characteristics: (Ta=25°C) (Test Condition: IF=20mA)

Part Number	Chip			Lens Type	Forward Voltage(VF) Unit:V		Luminous Intensity (Iv) Unit:mcd		Viewing Angle 2θ/2 (deg)
	Emitted Color	Material	λ _p (nm)		Typ	Max	Min.	Typ.	
					BL-L524UEC	Ultra Orange	AlGaInP	630	
BL-L524UYC	Ultra Yellow	AlGaInP	590	2.10	2.50	800	1500		
BL-L524UGC	Ultra Green	AlGaInP	574	2.20	2.50	300	800		
BL-L524PGC	Ultra Pure Green	InGaN	525	3.80	4.50	1500	3000		
BL-L524BGC	Ultra Bluish Green	InGaN	505	3.80	4.50	1000	2700		
BL-L524BC	Blue	InGaN	430	3.80	4.50	800	1500		
BL-L524UBC	Ultra Blue	InGaN	470	2.70	4.20	1200	2500		
BL-L524VC	UV	InGaN	405	3.80	4.50	60	90		
BL-L524UWC	Ultra White	InGaN	/	2.70	4.20	3000	10000		

Absolute maximum ratings (Ta=25°C)

Parameter	SR	LR	UR	UE	UY	UG	PG	BG	B	UB	UV	W	Unit
Forward Current I _F	25	25	25	30	30	30	30	30	30	30	30	30	mA
Power Dissipation P _d	60	60	60	65	65	75	110	110	120	120	120	120	mW
Reverse Voltage V _R	5	5	5	5	5	5	5	5	5	5	5	5	V
Peak Forward Current I _{PF} (Duty 1/10 @1KHZ)	150	150	150	150	150	150	150	100	100	100	100	100	mA
Operation Temperature T _{OPR}	-40 to +80												°C
Storage Temperature T _{STG}	-40 to +85												°C
Lead Soldering Temperature T _{SOL}	Max.260±5°C for 3 sec Max. (1.6mm from the base of the epoxy bulb)												°C

Bullet Type LED lamp

BL-L524

Package configuration & Internal circuit diagram

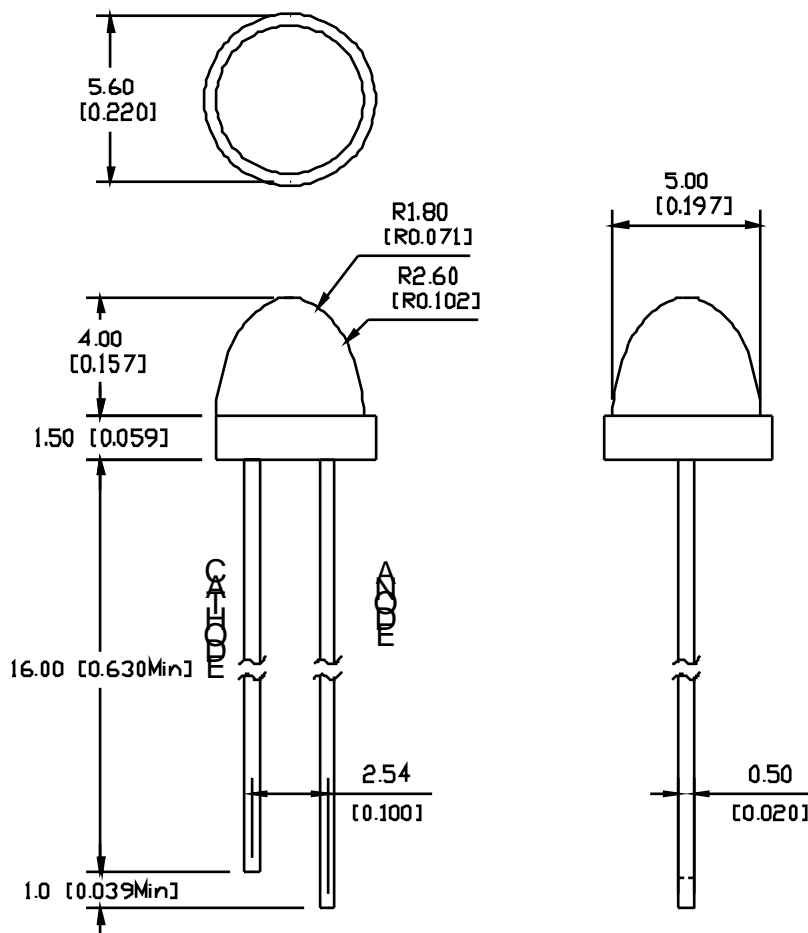

Notes:

1. All dimensions are in millimeters (inches)
2. Tolerance is ± 0.25 (0.01") unless otherwise noted.
3. Specifications are subject to change without notice.

Bullet Type LED lamp

BL-L524

Typical electrical-optical characteristics curves:

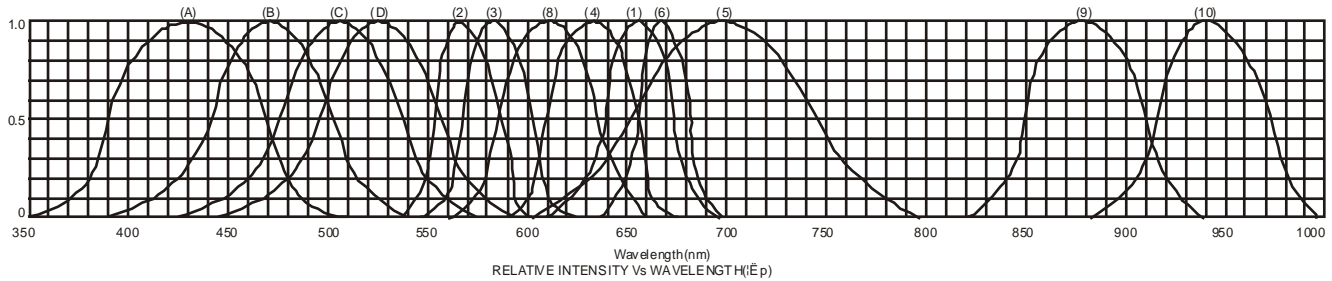

- (1) - GaAsP/GaAs 655nm/Red
- (2) - GaP 570nm/Yellow Green
- (3) - GaAsP/GaP 585nm/Yellow
- (4) - GaAsP/GaP 635nm/Orange & Hi-Eff Red
- (5) - GaP 700nm/Bright Red
- (6) - GaAlAs/GaAs 660nm/Super Red
- (8) - GaAsP/GaP 610nm/Super Red
- (9) - GaAlAs 880nm
- (10) - GaAs/GaAs & GaAlAs/GaAs 940nm
- (A) - GaN/SiC 430nm/Blue
- (B) - InGaN/SiC 470nm/Blue
- (C) - InGaN/SiC 505nm/Ultra Green
- (D) - InGaAlSiC 525nm/Ultra Green

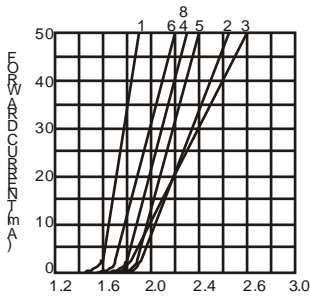

FORWARD VOLTAGE (Vf)
FORWARD CURRENT VS.
FORWARD VOLTAGE

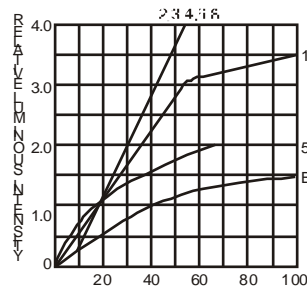

FORWARD CURRENT (mA)
RELATIVE LUMINOUS
INTENSITY VS. FORWARD
CURRENT

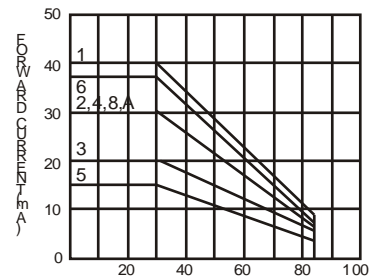

AMBIENT TEMPERATURE Ta ()
FORWARD CURRENT VS. AMBIENT
TEMPERATURE

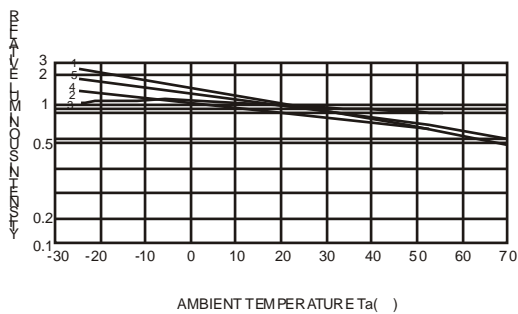

AMBIENT TEMPERATURE Ta ()

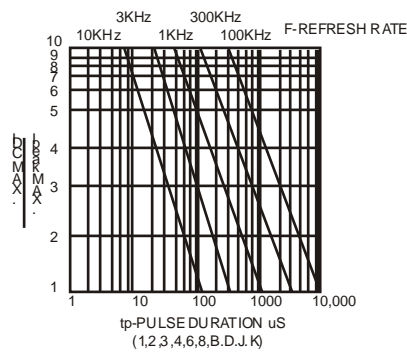

tp-PULSE DURATION μ s
(1,2,3,4,6,8,B,D,J,K)

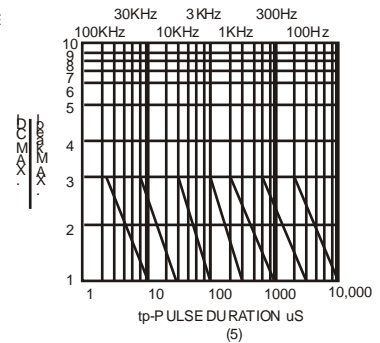

tp-PULSE DURATION μ s
(5)

NOTE:25 free air temperature unless otherwise specified

Bullet Type LED lamp

BL-L524

Packing and weighting

