

Part Number: CA25-12YWA

YELLOW

### Features

- 0.25 INCH DIGIT HEIGHT
- LOW CURRENT OPERATION.
- EXCELLENT CHARACTER APPEARANCE.
- EASY MOUNTING ON P.C. BOARDS OR SOCKETS.
- I.C. COMPATIBLE.
- CATEGORIZED FOR LUMINOUS INTENSITY.
- MECHANICALLY RUGGED.
- STANDARD : GRAY FACE, WHITE SEGMENT.
- RoHS COMPLIANT.

### Description

The Yellow source color devices are made with Gallium Arsenide Phosphide on Gallium Phosphide Yellow Light Emitting Diode.

### Package Dimensions & Internal Circuit Diagram

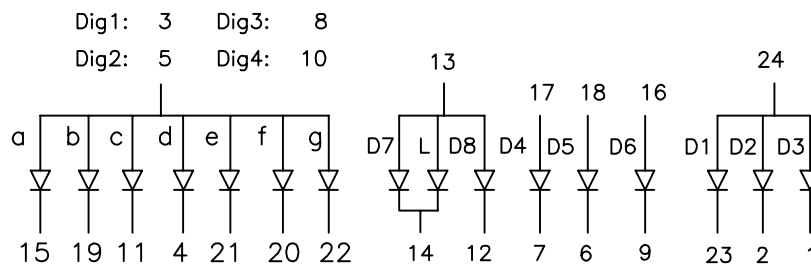
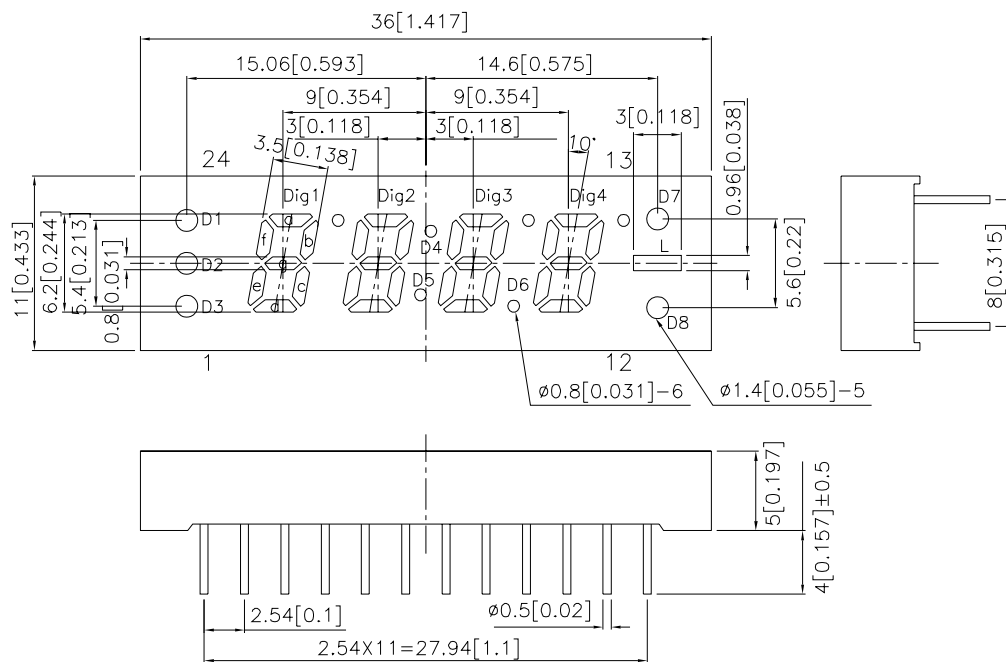

**Notes:**

1. All dimensions are in millimeters (inches), Tolerance is  $\pm 0.25(0.01)$  unless otherwise noted.
2. Specifications are subject to change without notice.

## Selection Guide

Part No.	Dice	Lens Type	Iv (ucd) [1] @ 10mA		Description
			Min.	Typ.	
CA25-12YWA	YELLOW (GaAsP/GaP)	WHITE DIFFUSED	1200	4850	Common Anode

Note:

1. Luminous intensity / luminous flux: +/-15%.

## Electrical / Optical Characteristics at TA=25°C

Symbol	Parameter		Device	Typ.	Max.	Units	Test Conditions
$\lambda_{peak}$	Peak Wavelength		Yellow	590		nm	IF=20mA
$\lambda_D$ [1]	Dominant Wavelength		Yellow	588		nm	IF=20mA
$\Delta\lambda_{1/2}$	Spectral Line Half-width		Yellow	35		nm	IF=20mA
C	Capacitance		Yellow	20		pF	VF=0V;f=1MHz
VF [2]	Forward Voltage	Dig1'8,'Dig2'8',Dig3'8',Dig4'8' D1,D2,D3D4,D5,D6,D8	Yellow	2.1	2.5	V	IF=20mA
		D7,L					
IR	Reverse Current	Dig1'8,'Dig2'8',Dig3'8',Dig4'8' D1,D2,D3D4,D5,D6,D8	Yellow		10	uA	VR = 5V
		D7,L			20		

Notes:

1. Wavelength: +/-1nm.

2. Forward Voltage: +/-0.1V.

## Absolute Maximum Ratings at TA=25°C

Parameter		Yellow	Units
Power dissipation	Dig1'8,'Dig2'8',Dig3'8',Dig4'8' D1,D2,D3D4,D5,D6,D8	75	mW
	D7,L	150	
DC Forward Current	Dig1'8,'Dig2'8',Dig3'8',Dig4'8' D1,D2,D3D4,D5,D6,D8	30	mA
	D7,L	60	
Reverse Voltage	Dig1'8,'Dig2'8',Dig3'8',Dig4'8' D1,D2,D3D4,D5,D6,D8	5	V
	D7,L		
Peak Forward Current [1]	Dig1'8,'Dig2'8',Dig3'8',Dig4'8' D1,D2,D3D4,D5,D6,D8	140	mA
	D7,L	280	
Operating/Storage Temperature		-40°C To +85°C	
Lead Solder Temperature [2]		260°C For 3~5 Seconds	

Notes:

1. 1/10 Duty Cycle, 0.1ms Pulse Width.

2. 2mm below package base.

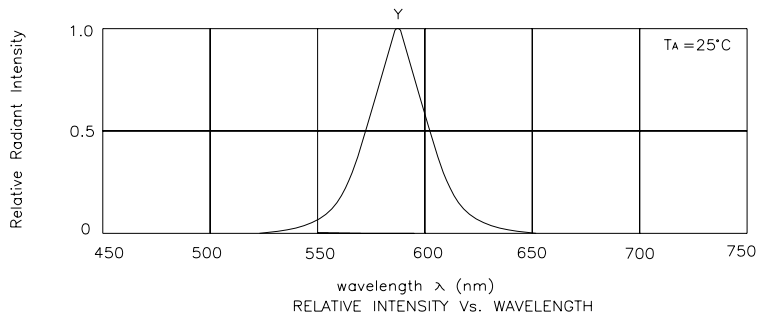

Yellow

CA25-12YWA

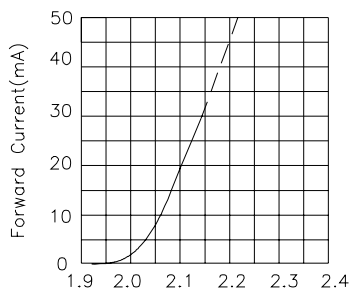

Forward Voltage(V)  
FORWARD CURRENT Vs  
FORWARD VOLTAGE

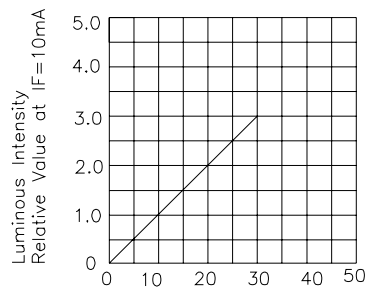

$I_F$ -Forward Current (mA)  
LUMINOUS INTENSITY Vs.  
FORWARD CURRENT

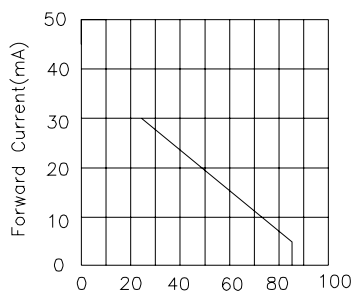

FORWARD CURRENT  
DERATING CURVE

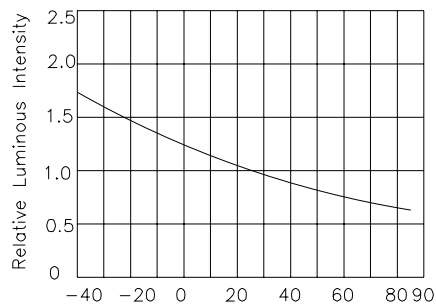

Ambient Temperature  $T_A$  ( $^\circ\text{C}$ )  
LUMINOUS INTENSITY Vs.  
AMBIENT TEMPERATURE

## Yellow

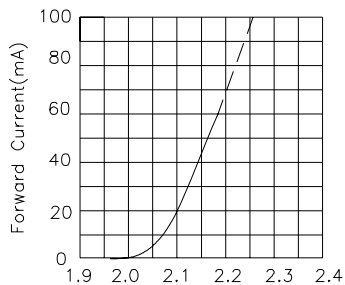

Forward Voltage(V)  
FORWARD CURRENT Vs  
FORWARD VOLTAGE

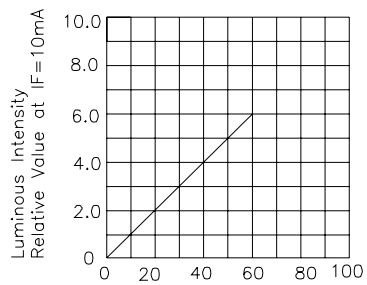

IF-Forward Current (mA)  
LUMINOUS INTENSITY Vs.  
FORWARD CURRENT

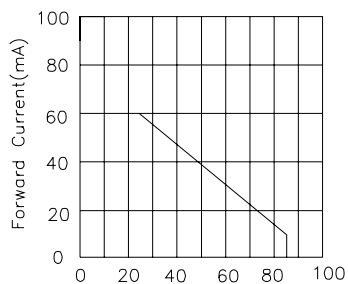

Ambient Temperature TA(°C)  
FORWARD CURRENT  
DERATING CURVE

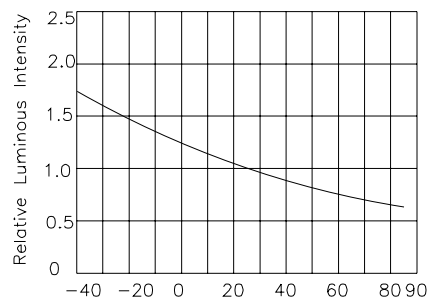

Ambient Temperature TA(°C)  
LUMINOUS INTENSITY Vs.  
AMBIENT TEMPERATURE

## PACKING & LABEL SPECIFICATIONS

## CA25-12YWA

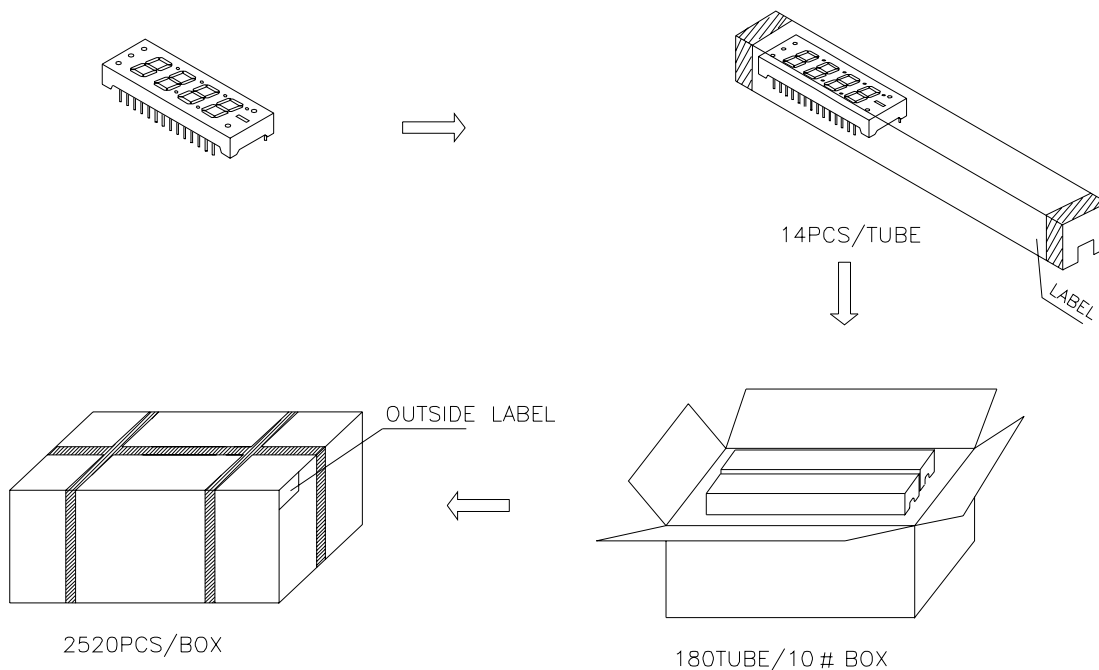

### Inside LABEL Paste On The IC-pipe

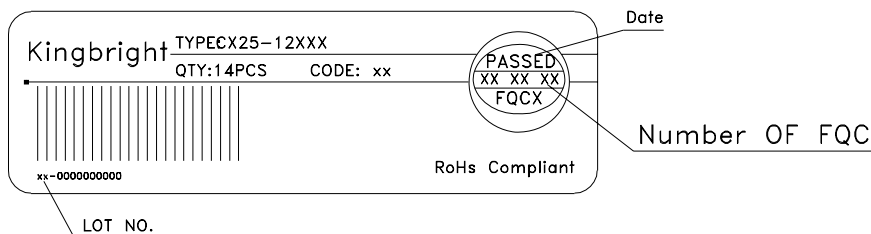

### Outside LABEL Paste On The Box

