

PLEASE CHECK WWW.MOLEX.COM FOR LATEST PART INFORMATION

Part Number: [0003066023](#)
Status: **Active**
Overview: [standard_062](#)
Description: 1.57mm (.062") Diameter Standard .062 Pin and Socket Receptacle Housing, 2 Circuits, Without Mounting Ears, Black

Documents:

3D Model	Product Specification PS-02-06 (PDF)
Packaging Specification (PDF)	RoHS Certificate of Compliance (PDF)
Drawing (PDF)	

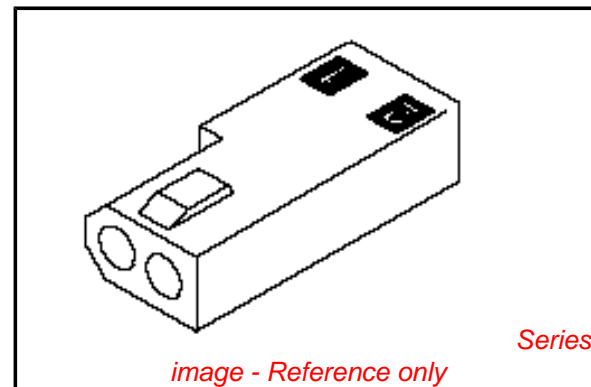

Agency Certification

CSA	LR19980
TUV	R72081037
UL	E29179

General

Product Family	Crimp Housings
Series	1625
Comments	Polarized to Mating Part
Overview	standard_062
Product Name	Standard .062"

Physical

Breakaway	No
Circuits (maximum)	2
Circuits Detail	1x2
Color - Resin	Natural
Flammability	94V-2
Gender	Receptacle
Glow-Wire Compliant	No
Keying to Mating Part	None
Lock to Mating Part	Yes
Material - Resin	Nylon
Number of Rows	1
Packaging Type	Bag
Panel Mount	No
Pitch - Mating Interface (in)	0.145 In
Pitch - Mating Interface (mm)	3.68 mm
Pitch - Term. Interface (in)	0.145 In
Pitch - Term. Interface (mm)	3.96 mm
Polarized to Mating Part	Yes
Stackable	No
Temperature Range - Operating	-40°C to +105°C

Electrical

Current - Maximum per Contact	5A
-------------------------------	----

Material Info

Old Part Number	162502R1BK
-----------------	------------

Reference - Drawing Numbers

Packaging Specification	PK-1625-001
Product Specification	PS-02-06
Sales Drawing	SD-1625-2*

EU RoHS

ELV and RoHS Compliant
REACH SVHC
 Not Reviewed
Halogen-Free Status
 Not Reviewed

China RoHS



Need more information on product environmental compliance?

Email productcompliance@molex.com
 For a multiple part number RoHS Certificate of Compliance, [click here](#)

Please visit the [Contact Us](#) section for any non-product compliance questions.

Search Parts in this Series

[1625Series](#)

Mates With

[1625 Plug](#)

Use With

Female Crimp Terminals [1561Link:4559](#), [4529](#), [2190](#), [2189](#), [1787](#), [1855](#). Male Crimp Terminals [1560](#), [1786](#), [1854](#), [1778](#). Male PC Tail Terminals. [1779](#) Female PC Tail Terminals

This document was generated on 06/07/2010

PLEASE CHECK WWW.MOLEX.COM FOR LATEST PART INFORMATION

13 12 11 10 9 8 7 6 5 4 3 2 1

J
I
H
G
F
E
D
C
B
A

J
I
H
G
F
E
D
C
B
A

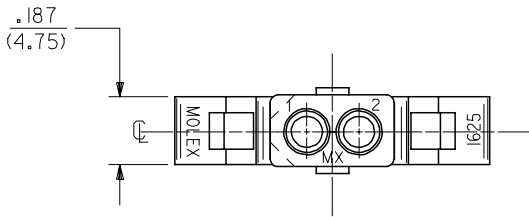

\triangle CIRCUIT I.D.

MOUNTING EAR (2 PL)
(WHEN SPECIFIED)
SEE DETAIL 3 OR 4

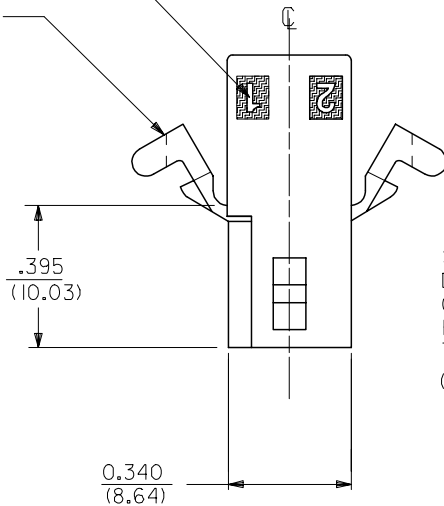

STANDARD
DETENT SHOWN.
OPTIONAL
POSITIVE LOCK
THIS SIDE ONLY
(SEE NOTE \triangle 5)

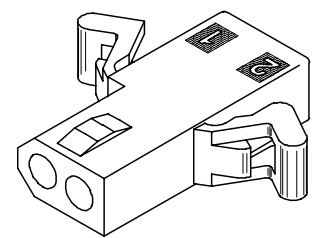
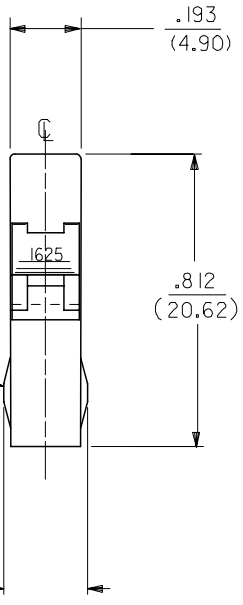

RECEPTACLE HOUSING
(1625-2R2 SHOWN)

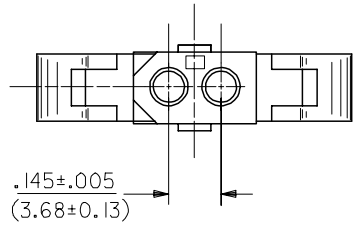

OPTIONAL POSITIVE LOCK
ONE SIDE ONLY
SCALE 4:1

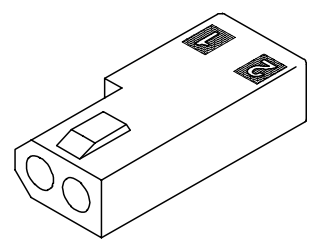
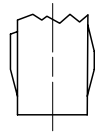

RECEPTACLE HOUSING
(1625-2R3 SHOWN)

UPDATE TITLE BLOCK EC NO: UCP2007-1980 DRAWN/PRI/DDR 2007/04/13 CHKD: AEL/HAG 2007/04/16 APPR: FSM/TH 2007/04/19 REV: A/1	QUALITY SYMBOLS $\blacktriangledown=0$ $\nabla=0$	GENERAL TOLERANCES (UNLESS SPECIFIED)		DIMENSION STYLE IN/MM		SCALE 4:1	DESIGN UNITS INCH	\odot \square THIRD ANGLE PROJECTION		
		4 PLACES \pm --- \pm --- 3 PLACES \pm --- \pm .007 2 PLACES \pm 0.18 \pm .010 1 PLACE \pm 0.25 \pm ---	mm INCH	DRAWN BY JJS	DATE 1988/04/14	TITLE PLUG & RECEPTACLE 2 CIRCUIT HOUSINGS .062/(1.57) DIA.	MATERIAL NO. RAS	DATE 1988/04/14	DOCUMENT NO. SD-1625-2*	SHEET NO. 2 OF 3
		DRAFT WHERE APPLICABLE MUST REMAIN WITHIN DIMENSIONS		SEE CHART		MOLEX INCORPORATED		THIS DRAWING CONTAINS INFORMATION THAT IS PROPRIETARY TO MOLEX INCORPORATED AND SHOULD NOT BE USED WITHOUT WRITTEN PERMISSION		

12 11 10 9 8 7 6 5 4 3 2 1

PLUG	
PART NO.	ENG. NO.
03-06-7023	I625-2PIBK
03-06-2023	I625-2P1
03-06-7027	I625-2P2BK
03-06-2024	I625-2P2

RECEPTACLE	
PART NO.	ENG. NO.
03-06-6023	I625-2RIBK
03-06-1020	I625-2R3
03-06-1023	I625-2R1
03-06-1022	I625-2R2
03-06-6025	I625-2R2RD
03-06-6026	I625-2R2GN
03-06-6027	I625-2R2BU
03-06-6022	I625-2R2BK
03-06-6028	I625-2R1BU

RECEPTACLE LEGEND:

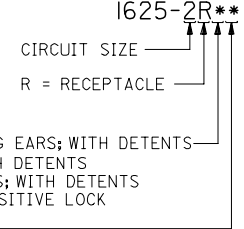

BLANK = WITH STANDARD MOUNTING EARS; WITH DETENTS
 1 = WITHOUT MOUNTING EARS; WITH DETENTS
 2 = WITH PREBENT MOUNTING EARS; WITH DETENTS
 3 = W/O MOUNTING EARS, WITH POSITIVE LOCK

BLANK = NATURAL
 AM=AMBER BK=BLACK BU=BLUE
 BN=BROWN GY=GRAY GN=GREEN
 OR=ORANGE RD=RED YW=YELLOW

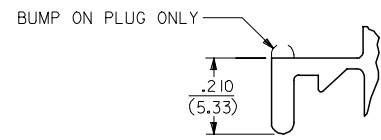

DETAIL 3
STANDARD MOUNTING EARS
(SCALE 4:1)

PLUG LEGEND:

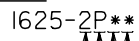

1 = WITHOUT MOUNTING EARS
 2 = WITH PREBENT MOUNTING EARS
 3 = W/O MOUNTING EARS, WITH POSITIVE LOCK

BLANK = NATURAL
 AM=AMBER BK=BLACK BU=BLUE
 BN=BROWN GY=GRAY GN=GREEN
 OR=ORANGE RD=RED YW=YELLOW

MAX. PANEL THICKNESS .060/(1.52)

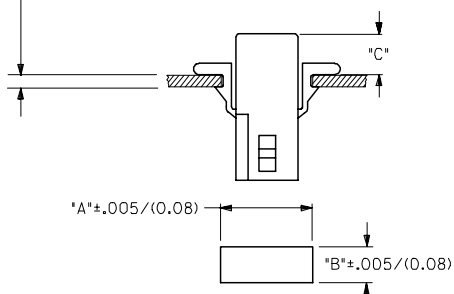

RECOMMENDED HOLE PATTERN

HOUSING	DIM. "A"	DIM. "B"	PREBENT EAR DIM. "C"	STD. EAR DIM. "C"
PLUG	.609 (15.47)	.318 (8.08)	.24 (6.0)	.24 (6.1)
RECEPTACLE	.505 (12.83)	.265 (6.73)	.25 (6.4)	.25 (6.4)

NOTES:

1. MATERIAL - NYLON TYPE 6/6, 94V-2
2. FINISH: NONE
3. PRODUCT SPECIFICATION: PS-02-06
4. PACKAGING SPECIFICATION: PK-1625-001
5. POSITIVE LOCK VERSION REQUIRES USE OF A SCREWDRIVER OR SIMILAR TOOL TO LIFT SHROUD ON PLUG HOUSING IN ORDER TO UNMATE RECEPTACLE HOUSINGS
6. HOUSINGS FOR USE WITH MOLEX .062/(1.57) DIA. SERIES TERMINALS.
7. CIRCUIT I.D. NUMBERS ON SIDE OF HOUSING APPEAR ON PARTS FROM TOOLS BUILT AFTER 07/01/1991.
8. THIS PART CONFORMS TO CLASS B REQUIREMENTS OF COSMETIC SPECIFICATION PS-45499-002.

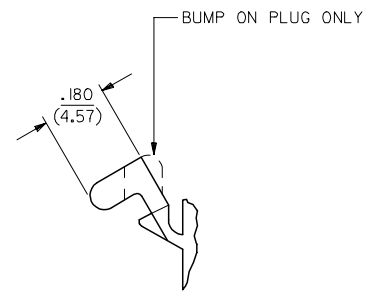

DETAIL 4

PREBENT MOUNTING EARS
(SCALE 4:1)

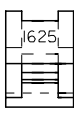

UPDATE NOTES EC NO: UCP2007-1980 DRAWN: PPR/DDEE CHKD: AEL/HAG APPR: FSM/TH 2007/04/13 2007/04/16 2007/04/19	QUALITY SYMBOLS ▽=0 ▽=0	GENERAL TOLERANCES (UNLESS SPECIFIED)		DIMENSION STYLE IN/MM		SCALE 2:1	DESIGN UNITS INCH	THIRD ANGLE PROJECTION	
		4 PLACES ± --- ± --- 3 PLACES ± --- ± .007 2 PLACES ± 0.18 ± .010 1 PLACE ± 0.25 ± --- ANGULAR ± 1 °	DRAWN BY JJS DATE 1988/04/14	CHECKED BY RW DATE 1988/04/14	TITLE PLUG & RECEPTACLE 2 CIRCUIT HOUSINGS .062(1.57)DIA.				
		DRAFT WHERE APPLICABLE MUST REMAIN WITHIN DIMENSIONS		APPROVED BY RAS DATE 1988/04/14	MATERIAL NO. SEE CHART			DOCUMENT NO. SD-1625-2*	SHEET NO. 3 OF 3
		THIS DRAWING CONTAINS INFORMATION THAT IS PROPRIETARY TO MOLEX INCORPORATED AND SHOULD NOT BE USED WITHOUT WRITTEN PERMISSION							