

■ Package Dimension:

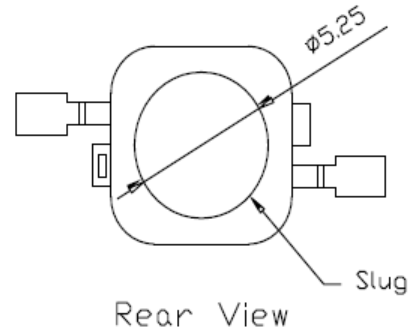

Recommended Soldering Pad

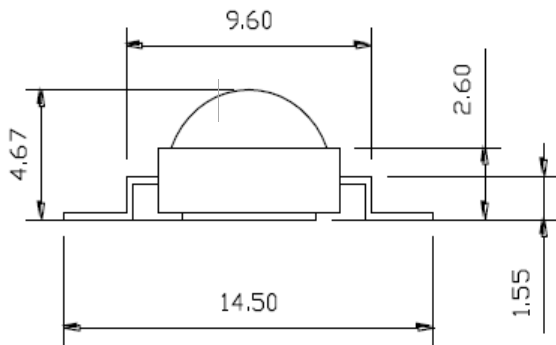
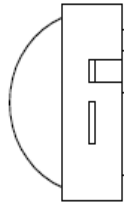
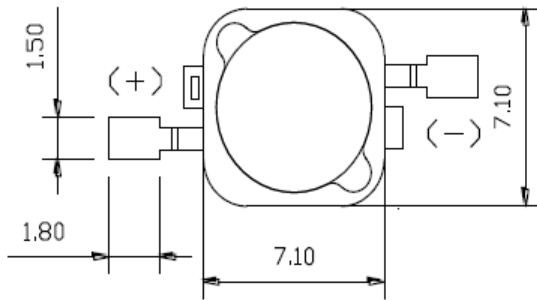
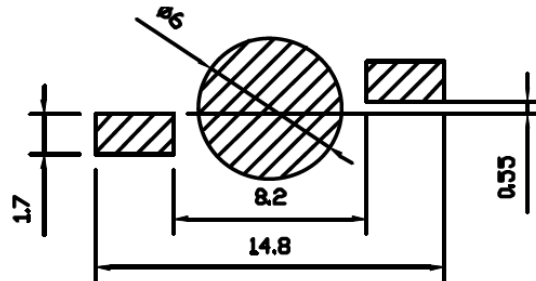

Part NO.	Chip	Emitting Color	Lens Color
AL-01K5UV3WC-3A2	InGaN	UV	Water Clear

Notes:

1. All dimensions are in millimeters (inches).
2. Tolerance is $\pm 0.25\text{mm}$ (.010") unless otherwise noted.
3. Protruded resin under flange is 1.0mm(.04") max.
4. Lead spacing is measured where the leads emerge from the package.
5. Specifications are subject to change without notice.
6. This data-sheet only valid for six months.

■ Absolute Maximum Ratings at Ta=25°C

Parameter	Symbol	MAX.	Unit
DC Forward Current	I _F	700	mA
Reverse Voltage	V _R	5	V
Power Dissipation	P _D	2.48	W
Pulse Forward Current	I _{FP}	1000	mA
LED junction Temperature (at 350mA)	T _j	125	°C
Thermal Resistance	R _{th}	10	K/W
Operating Temperature Range	Topr	-40°C to +100	°C
Storage Temperature Range	Tstg	-40°C to +100	°C
Manual Soldering Time at 260°C (Max.)	Tsol	5	seconds

Notes:

1. Maximum DC forward current is determined by the overall thermal resistance and ambient temperature.
2. I_{FP} conditions: pulse width $\leq 1\text{ms}$ and duty cycle $\leq 10\%$.

■ Electrical Optical Characteristics at Ta=25°C

Parameter	BIN	Symbol	Min.	Typ.	Max.	Unit	Test Condition
Power Consumption	S10	Radiometric Power	620	---	660	mW	I _F =500mA
	S11		660	---	700		
	S12		700	---	740		
	S13		740	---	780		
	S14		780	---	820		
Forward Voltage		V _F	3	---	4	V	I _F =500mA
Peak Wavelength		λ _p	400	---	410	nm	I _F =500mA
Spectra Half Widh		Δλ	12	---	25	nm	I _F =500mA
Reverse Current		I _R	---	---	2	μA	I _F =500mA
Emission Angle		2θ _{1/2}	---	120	---	Deg	I _F =500mA

Notes:

1. Ranking at Ts=25°C.
2. Forward Voltage Tolerance: ±0.05V.
3. Radiometric Power Tolerance: ±10%.
4. Peak Wavelength Tolerance: ±2nm.
5. LEDs from the above ranks will be shipped.

■ Forward Voltage Binning

Part number	Forward Voltage at Test Current (500mA)		
	Vf Group	Minimum Voltage (V)	Maximum Voltage (V)
	V30	3.0	3.2
	V32	3.2	3.4
	V34	3.4	3.6
	V36	3.6	3.8
	V38	3.8	4.0

■ Characteristics Curves $T_J=25^{\circ}\text{C}$

RELATIVE SPECTRAL POWER DISTRIBUTION

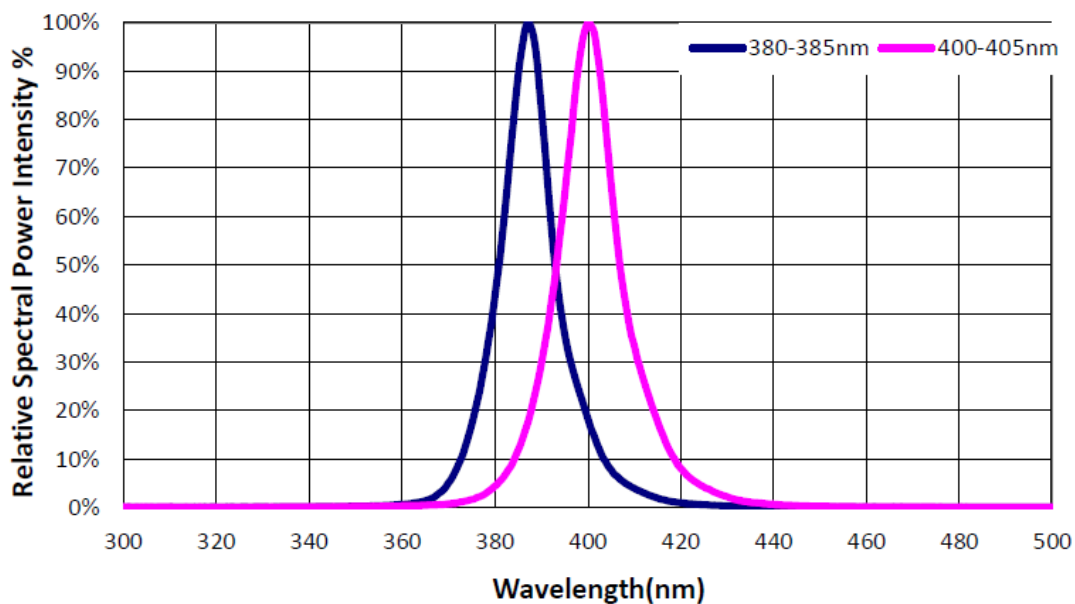

SPATIAL DISTRIBUTION

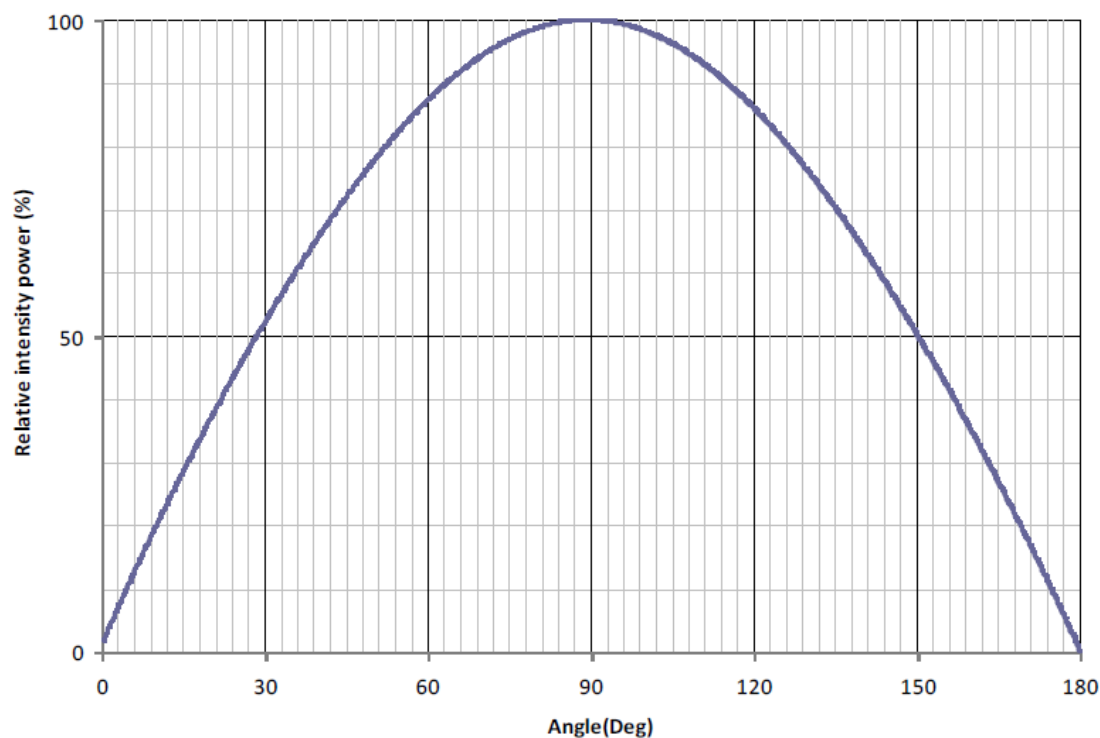

■ Characteristics Curves $T_J=25^{\circ}\text{C}$

TYPICAL FORWARD L-I CHARACTERISTICS

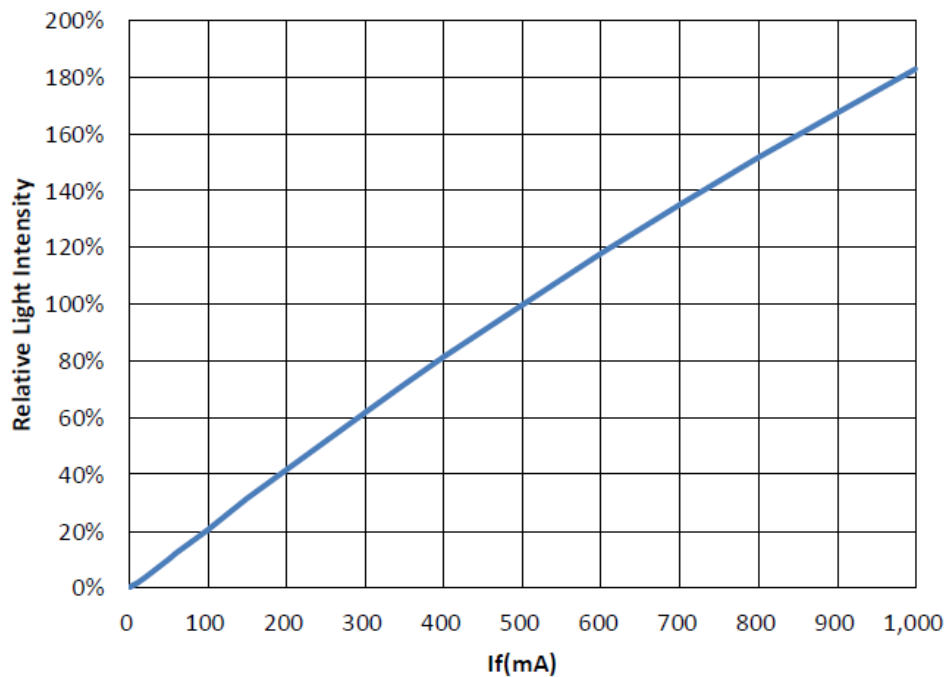

TYPICAL FORWARD I-V CHARACTERISTICS

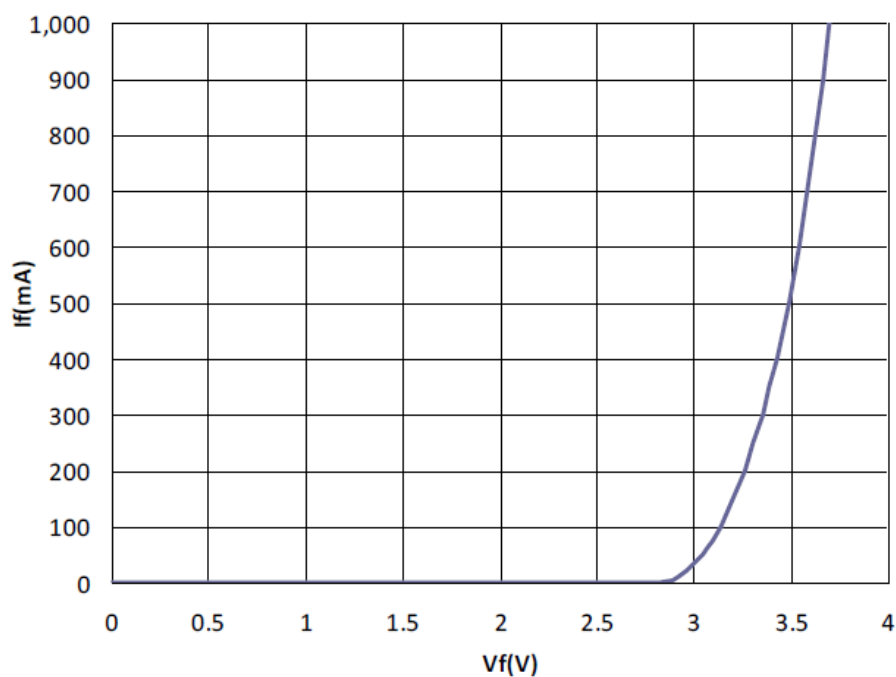

TAPE AND REEL

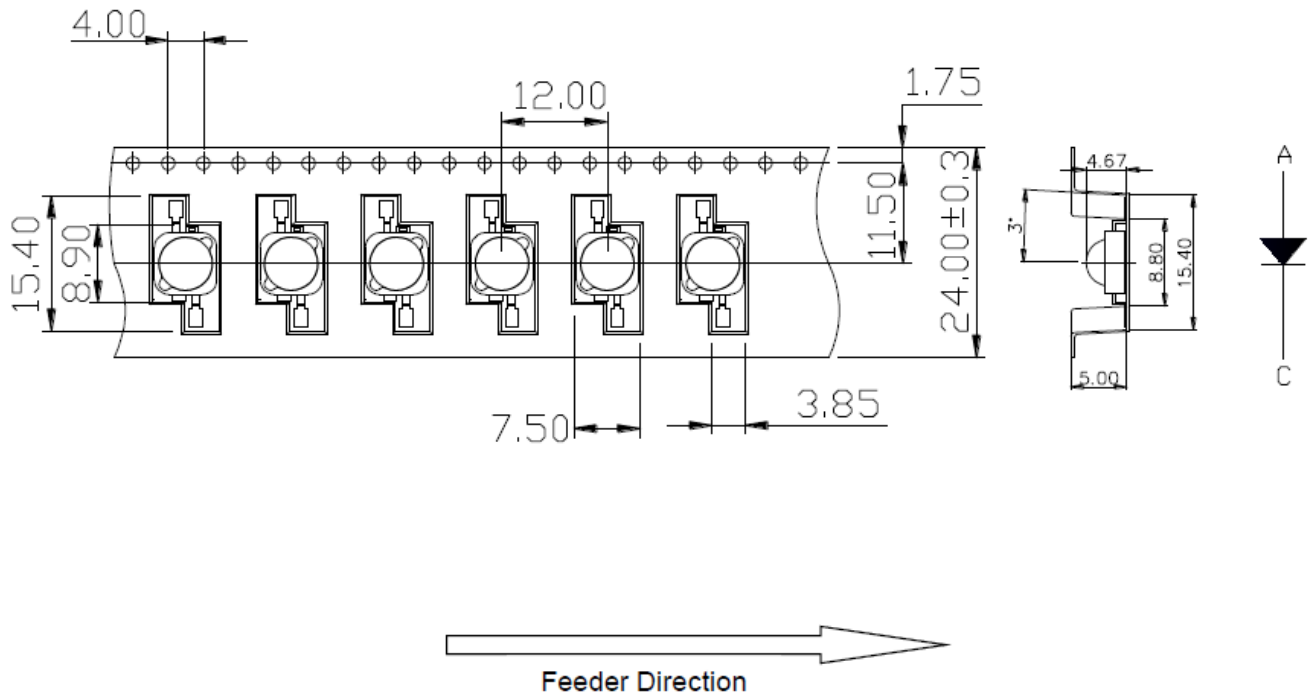

Notes:

1. All dimensions are in millimeter.
2. Tolerance is ±0.10mm unless otherwise noted.