

DESCRIPTION

The EV3414-J-00A is a Boost converter evaluation board for the MP3414, a synchronous, 1MHz fixed frequency, current mode step-up converter with output to input disconnect. The device can step up single-cell and two-cell alkaline, NiCd, and NiMH batteries up to 4V.

It can startup from an input voltage as low as 0.8V and provides inrush current limiting as well as output short circuit protection.

The output voltage also can be regulated when $V_{IN} > V_{OUT}$, and the P-channel MOS is no longer act as a low impedance switch.

The EV3414-J-00A regulates the output voltage up to 3.3V from single cell AA battery without the uses of an external Schottky diode.

The MP3414 is offered in a TSOT23-8 package.

ELECTRICAL SPECIFICATION

Parameter	Symbol	Value	Units
Input Voltage	V_{IN}	0.8-4	V
Output Voltage	V_{OUT}	3.3	V

FEATURES

- Up to 96% Efficiency
- True Output Load Disconnect
- Input Range: 0.6V to 4V
- Output Range: 1.8V to 4V
- 0.8V Low Voltage Start-Up
- Current Mode Control with Internal Compensation
- Short-Circuit Protection
- True Output Disconnect from Input
- $V_{IN} > V_{OUT}$ Down Mode Operation
- High Efficiency at Light Load Conditions
- Inrush Current Limit and Internal Soft-Start
- 1MHz Fixed Frequency Switching
- Tiny External Components

APPLICATION

- Single-Cell and Two-Cell Alkaline, NiCd, or NiMH Batteries Powered Products
- Personal Medical Devices
- Portable Media Players
- Wireless Peripherals
- Handheld Computers and Smart phones

All MPS parts are lead-free and adhere to the RoHS directive. For MPS green status, please visit MPS website under Quality Assurance. GPS Receivers "Monolithic Power Systems", "MPS", and "The Future of Analog IC Technology" are Registered Trademarks of Monolithic Power Systems, Inc.

EV3414-J-00A EVALUATION BOARD

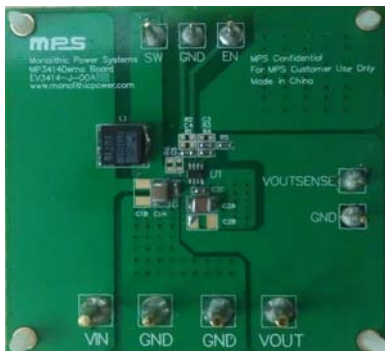

Board Number	MPS IC Number
EV3414-J-00A	MP3414-J

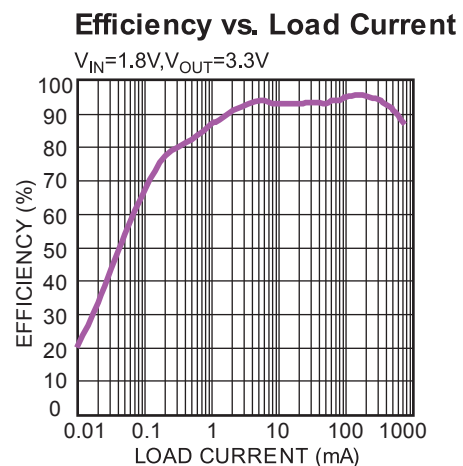

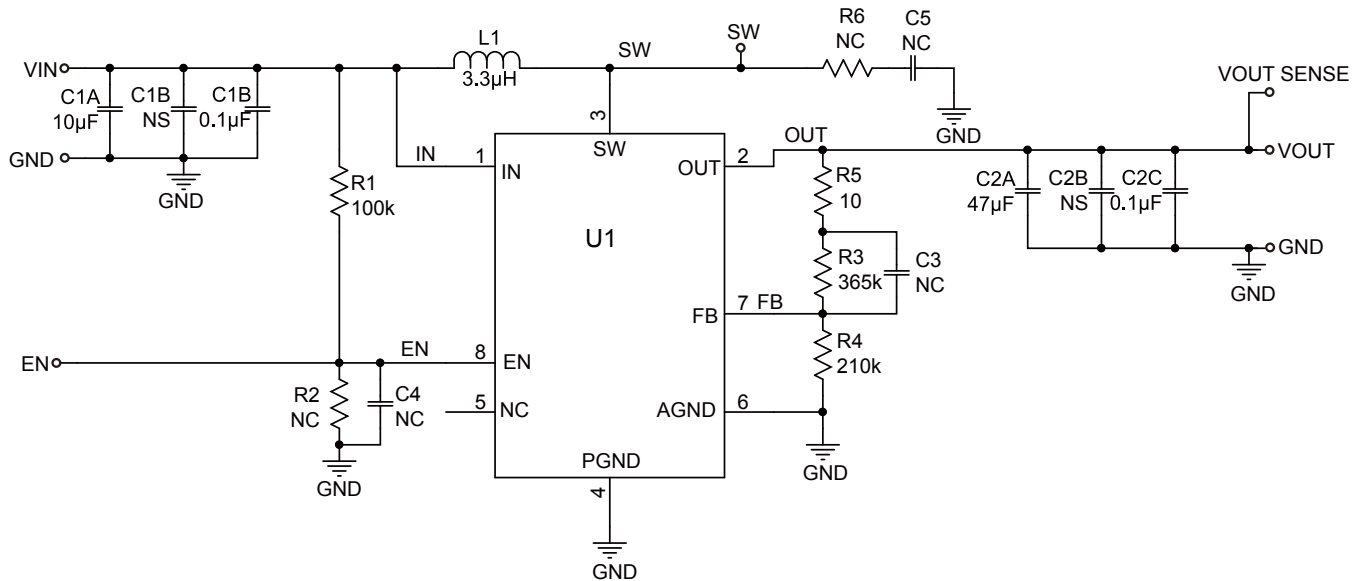
EVALUATION BOARD SCHEMATIC

EV3414-J-00A BILL OF MATERIALS

Qty	RefDes	Value	Description	Package	Manufacturer	Manufacturer_P/N
1	C1A	10µF	Ceramic Cap., 10V, X7R	1210	muRata	GRM32DR71C106KA01L
1	C2A	47µF	Ceramic Cap., 10V, X7R	1210	muRata	GRM32ER61A476KE20L
2	C1C, C2C	0.1µF	Ceramic Cap., 50V, X7R	0603	muRata	GRM188R71C104KA01D
5	C1B, C2B, C3, C4, C5	NS	Not Stuff			
1	R1	100k	Film Res., 1%	0603	Yageo	RC0603FR-07100KL
1	R3	365k	Film Res., 1%	0603	Yageo	RC0603FR-07365KL
1	R4	210k	Film Res., 1%	0603	Yageo	RC0603FR-07210KL
1	R5	10	Film Res., 5%	0603	Yageo	RC0603JR-0710R0L
2	R2, R6	NS	Not Stuff			
1	L1	3.3µH	20mOhm DCR, 2.5A	SMD	Würth	744062003
			20mOhm DCR, 2.5A	SMD	TDK	SLF7045T-3R3M2R5-PF
			21mOhm DCR, 2.57A	SMD	TOKO	D63CB-#A916CY-3R3M
1	U1		Step-Up Converter	TSOT23-8	MPS	MP3414-J

EVB TEST RESULTS

Performance waveforms are tested on the evaluation board.

$V_{IN} = 1.8V$, $V_{OUT} = 3.3V$, $L = 3.3\mu H$, $T_A = 25^\circ C$, unless otherwise noted.

OUTPUT VOLTAGE RIPPLE (PSM)

$V_{IN}=1.8V, V_{OUT}=3.3V, I_{OUT}=20mA$

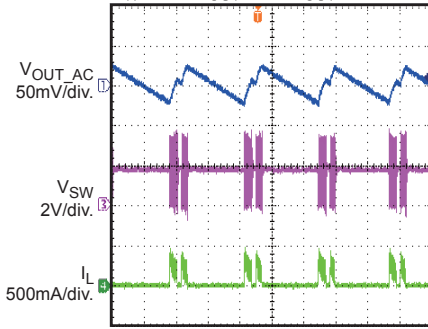

OUTPUT VOLTAGE RIPPLE (CCM)

$V_{IN}=1.8V, V_{OUT}=3.3V, I_{OUT}=500mA$

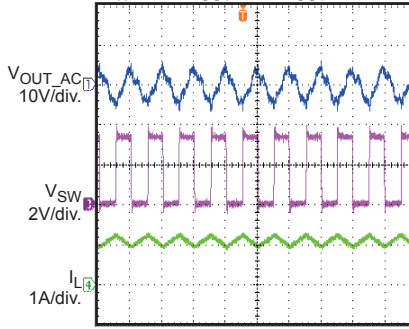

EN start up

$I_{OUT}=500mA$

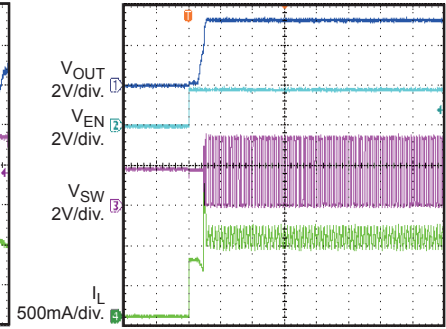

EN start up

$I_{OUT}=20mA$

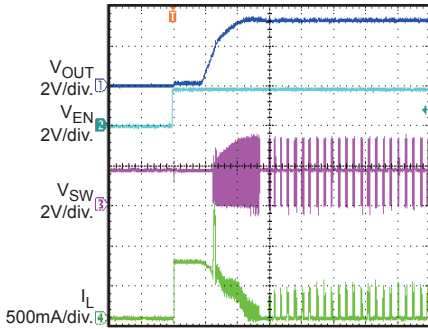

Load Transient

$I_{OUT}=100mA$ to $200mA$ step

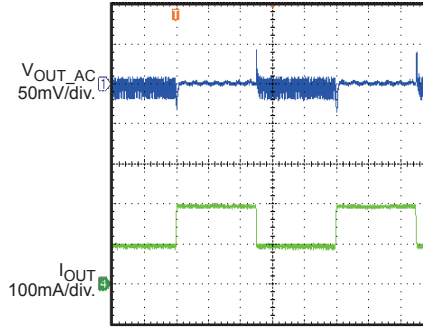

Load Transient

$I_{OUT}=200mA$ to $500mA$ step

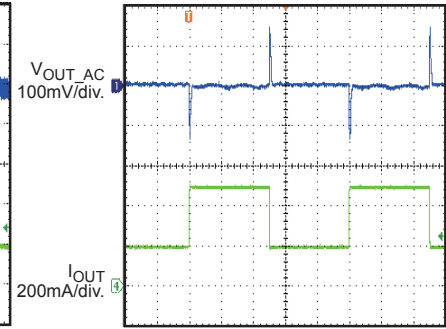

Line Transient

$V_{IN}=1.8V$ to $2.4V$ step, $V_{OUT}=3.3V$
 $I_{OUT}=100mA$

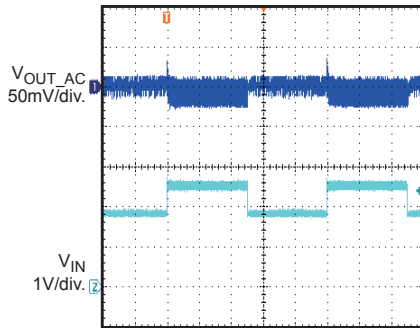

Line Transient

$V_{IN}=1.8V$ to $2.4V$ step, $V_{OUT}=3.3V$
 $I_{OUT}=500mA$

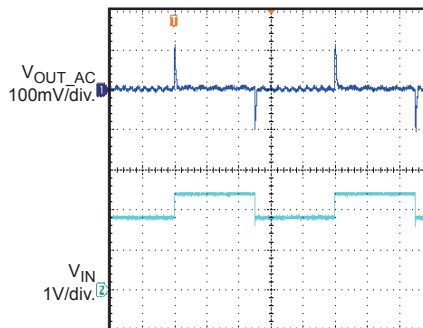

PRINTED CIRCUIT BOARD LAYOUT

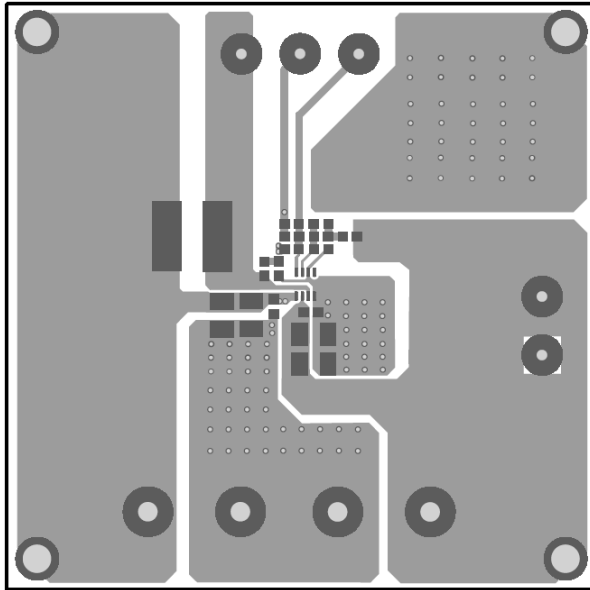

Figure 1—Top Layer

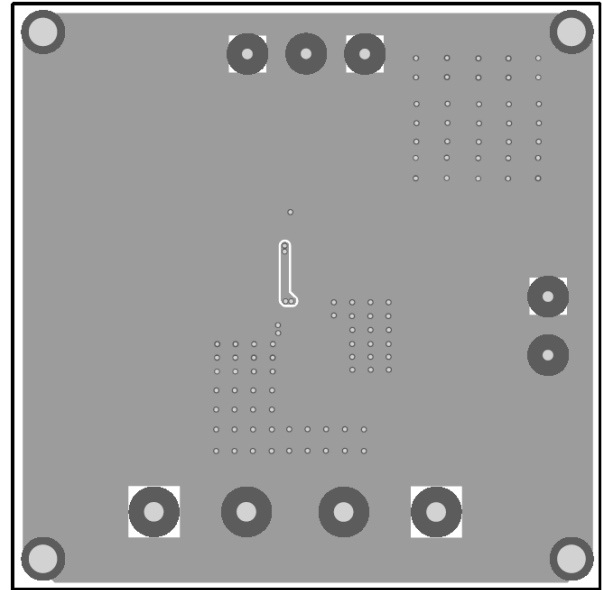

Figure 2—Bottom Layer

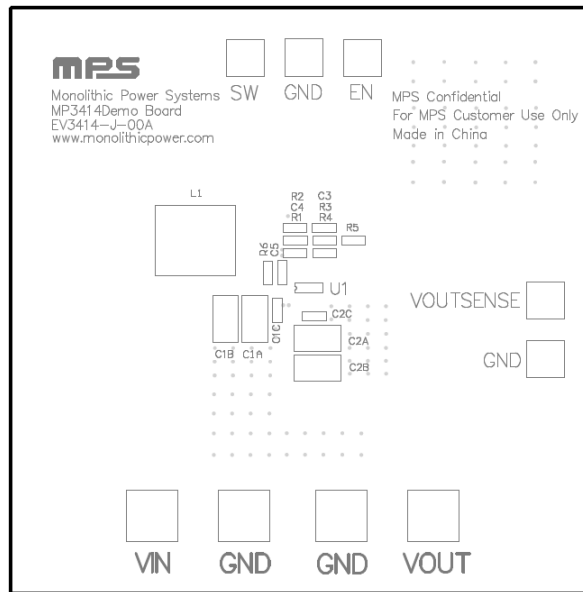

Figure 3—Top Silk Layer

QUICK START GUIDE

The output voltage of this board is set to 3.3V. The board layout accommodates most commonly used inductors and output capacitors.

1. Preset power supply to $0.8V \leq V_{IN} \leq 4V$;
2. Turn off the power supply;
3. Connect power supply terminals to

Positive (+): IN
Negative (-): GND

4. Connect Load to:

Positive (+): OUT
Negative (-): GND

5. Connect the EN to $\geq 0.8 * V_{IN}$ power supply, or connect the EN to VIN.

Positive (+): EN
Negative (-): GND

6. Turn on the power supply;
7. The output voltage V_{OUT} can be adjusted by changing R4. And the value of R4 can be calculated by the following formula:

$$R4 = R3 \times \left(\frac{V_{FB}}{V_{OUT} - V_{FB}} \right)$$

Where $V_{FB}=1.21V$ and $R3=365k\Omega$

For example, if $V_{OUT}=3.3V$

$$R4 = 365k\Omega \times \left(\frac{1.21}{3.3 - 1.21} \right) = 211.3k\Omega$$

Therefore use a 210k Ω resistor.

8. The V_{OUT} in the EVB is set to 3.3V, if other output is need the R4 can be changed.

NOTICE: The information in this document is subject to change without notice. Users should warrant and guarantee that third party Intellectual Property rights are not infringed upon when integrating MPS products into any application. MPS will not assume any legal responsibility for any said applications.