

RoHS

CAD GENERATED DRAWING. DON'T CHANGE BY HAND.

REV.	ECN. NO.	APPD.

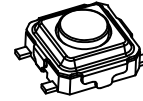
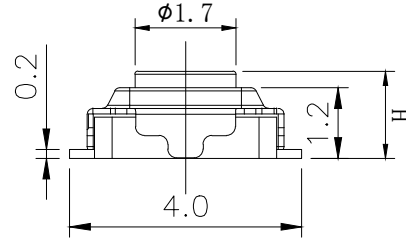
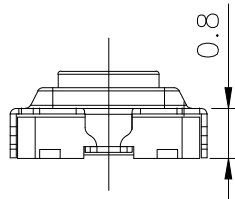
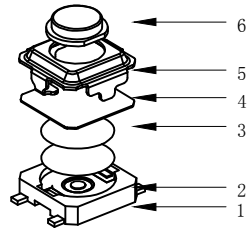

	H
A	1.5
B	1.7
C	2.0

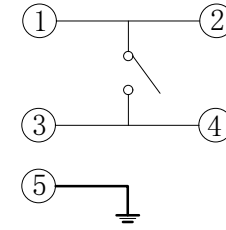

CIRCUIT DIAGRAM

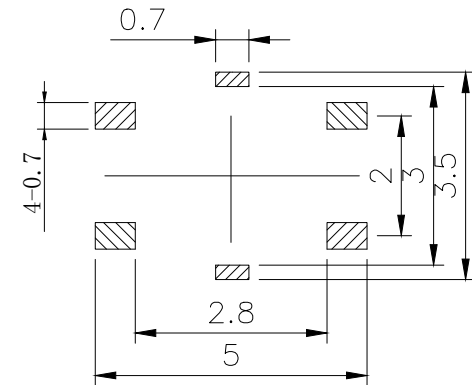

PCB. WELDING DRAWING

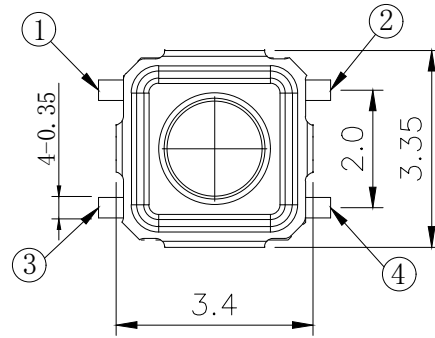

Specification

Rate voltage,current	50mA DC12V
Contact resistance	≤100mΩ
Operating force	250±50gf
Travel	0.20±0.10mm
Insulated resistance	≥100MΩ
Dielectric strength	≥250VAC/1min
Life cycle	≥100000次

ITEM	PART NAME	Q' TY	MATERIAL	FINSH/COLOR
6	Button	1	LCP	
5	Cover	1	Stainless steel	Silver
4	Dust film	1	Polyimide	Orange
3	Shrapnel	2	Stainless steel	Silver
2	Housing	1	LCP	Gray
1	Cards	1	Brass	Silver

THESE DRAWINGS AND SPECIFICATIONS ARE THE PROPERTY OF YIYUAN TECHNOLOGY CO.,LTD AND SHALL NOT BE REPRODUCED, COPIED OR USED IN ANY MANNER WITHOUT THE PRIOR WRITTEN CONSENT OF YIYUAN TECHNOLOGY CO.,LTD

X. ±0.50	X.° ± 2°	UNITS
.X ±0.30	.X° ± 1°	mm
.XX ±0.10	.XX° ± 0.5°	MAT'L
.XXX ± 0.05		FINISH
		Q' TY

	深圳市怡远科技有限公司 SHENZHEN YIYUAN TECHNOLOGY CO.,LTD							
	PART NO. YTS-A007-2H	TITLE: TACTILE SWITCH						
APPD: ROGER	DWG NO. : YTS-A007-2H							
CHKD: ROC	<table border="1"> <tr> <th>SCALE</th> <th>SHEET</th> <th>REV.</th> </tr> <tr> <td>1/1</td> <td>1/1</td> <td>A1</td> </tr> </table>		SCALE	SHEET	REV.	1/1	1/1	A1
SCALE	SHEET	REV.						
1/1	1/1	A1						
DR: BILLY WANG 2020/08/21								