

for Wonderful Cruising

Safe + Comfortable Cabin

EM6011
Hall Effect Latch**1. General Description**

The EM6011 is a Hall effect latch which detects magnetic field. The output is switched according to the magnetic field applied to the device.

2. Features

- | | | |
|--------------------------|----------------------------|--|
| <input type="checkbox"/> | Supply Voltage: | 3.8 to 24V |
| <input type="checkbox"/> | Operation Temperature: | -40 to 150°C |
| <input type="checkbox"/> | Sensitivity: | ±2.0mT(Typ.), ±3.0mT(Max.) |
| <input type="checkbox"/> | Output: | N-MOS Open Drain Output |
| <input type="checkbox"/> | Reverse Battery Protection | |
| <input type="checkbox"/> | Package: | 3-pin SOP Type
(Small Package size, RoHS Compliant, Halogen free) |

3. Table of Contents

1. General Description	1
2. Features	1
3. Table of Contents	2
4. Block Diagram and Functions	3
4.1. Block Diagram	3
4.2. Functions	3
5. Pin Configurations and Functions	4
5.1. Pin Configurations	4
5.2. Functions	4
6. Absolute Maximum Ratings	5
7. Recommended Operating Conditions	5
8. Electrical Characteristics	6
9. Magnetic Characteristics	7
10. Operating Characteristics	8
10.1. Definition of Magnetic Field	8
11. Recommended External Circuit	9
12. Typical Characteristics Data (for reference)	10
13. Package	11
13.1. Outline Dimensions	11
13.2. Material of Terminals	11
13.3. Land Pattern	12
13.4. Marking	12
IMPORTANT NOTICE	13

4. Block Diagram and Functions

4.1. Block Diagram

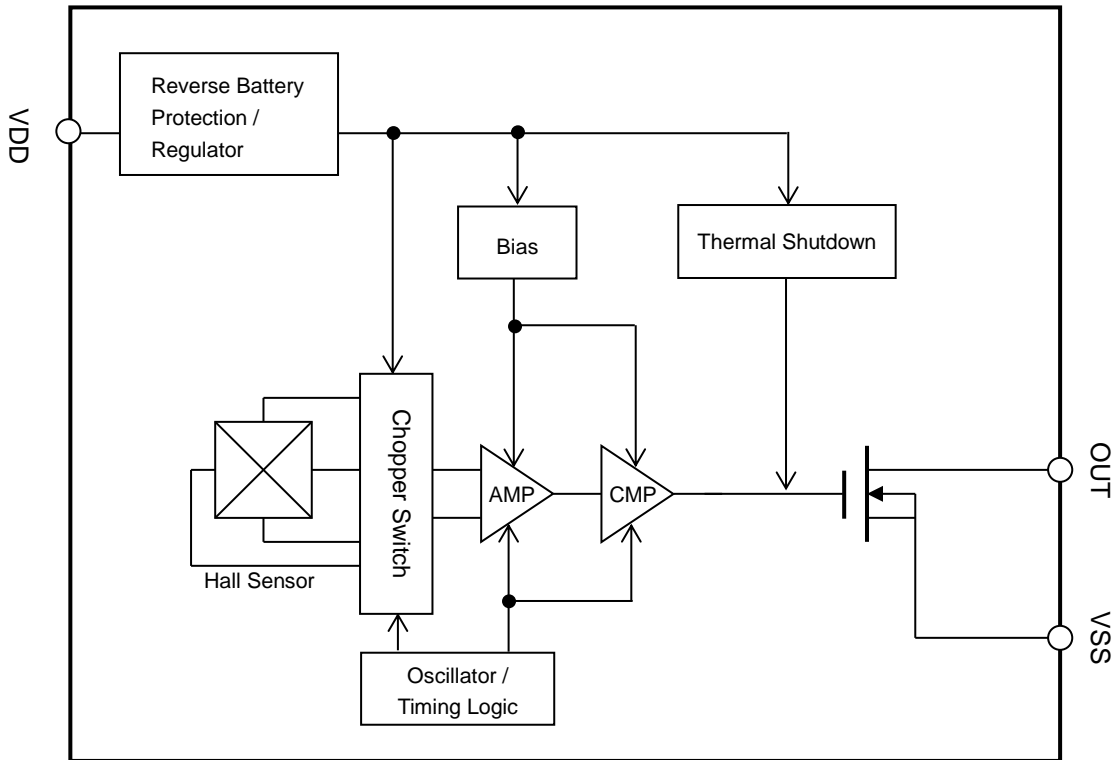


Figure 1. EM6011 Block Diagram

4.2. Functions

Table 1. Circuit configuration

Block Name	Function
Hall Sensor	Hall element fabricated by CMOS process.
Chopper Switch	Hall sensor drive switch. Perform chopping in order to cancel the offset of Hall sensor.
Reverse Battery Protection	To protect the IC from reverse-voltage (VDD pin)
Regulator	Generate internal operating voltage.
Bias	Generate bias current to internal circuits.
AMP	Amplify Hall sensor output voltage with summation and subtraction circuit.
CMP	Hysteresis comparator.
Oscillator	Generate operational clock.
Timing Logic	Generate timing signal for internal circuits.
Thermal Shutdown	Turn the output off when a measured temperature is beyond the specific value.

5. Pin Configurations and Functions

5.1. Pin Configurations

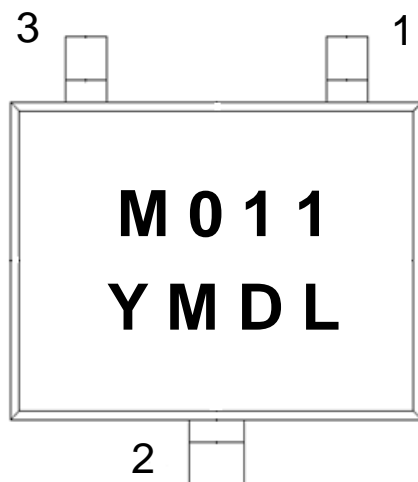


Figure 2. Pin Layout

5.2. Functions

Table 2. Description of pin name and function

Pin No.	Pin Name	I/O	Function	Description
1	VDD	–	Power Supply pin	
2	VSS	–	Ground pin (GND)	
3	OUT	O	Output pin	Open Drain

6. Absolute Maximum Ratings

Table 3. Absolute maximum ratings

Parameter	Symbol	Min.	Max.	Unit	Description
Supply voltage	V_{DD}	-30	30	V	VSS = 0V
Output voltage	V_{OUT}	-0.3	30	V	OUT pin (VSS= 0V)
Output current	I_{SINK}	-50	50	mA	OUT pin
Operating ambient temperature	T_a	-40	150	°C	
Storage temperature	T_{STG}	-65	170	°C	

Operation at or beyond these limits may result in permanent damage to the device. Normal operation is not guaranteed at these extremes.

7. Recommended Operating Conditions

Table 4. Recommended operating conditions

Parameter	Symbol	Min.	Typ.	Max.	Unit	Description
Supply voltage	V_{DD}	3.8	12	24	V	(*1)
Output Voltage	V_{OUT}	0		24	V	
Output current	I_{SINK}	0		35	mA	
Output Load carrying capacity	C_L			100	pF	

*1. Supply voltage refers to the following.

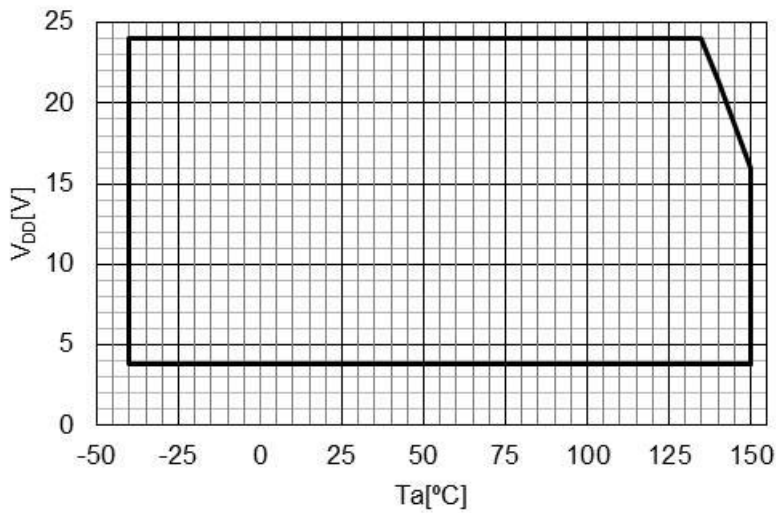


Figure 3. Supply Voltage

8. Electrical Characteristics

Table 5. Electrical characteristics at $V_{DD} = 3.8$ to $24V$, $T_a = -40$ to $150^{\circ}C$ (Typ. $T_a = 25^{\circ}C$, $V_{DD} = 12V$)

Parameter	Symbol	Min.	Typ.	Max.	Unit	Condition, Note	Description
Supply current	I_{DD}		3	5	mA	Output "off", "on"	
Output leakage current	I_{LEAK}		0	10	μA	Output "off"	
Output saturation voltage	V_{SAT}			0.4	V	Output "on" $I_{SINK} = 20mA$	
Output rise time	T_r			1	μs	$V_{DD} = 12V$ $R_L = 820\Omega$, $C_L = 20pF$ $V_{OUT} = 10\%V_{DD} \sim 90\%V_{DD}$	
Output fall time	T_f			1	μs	$V_{DD} = 12V$ $R_L = 820\Omega$, $C_L = 20pF$ $V_{OUT} = 90\%V_{DD} \sim 10\%V_{DD}$	
Revers supply current	I_{RDD}			-0.1	mA	$V_{DD} = -30V$	
Output Refresh Period	T_o		8.3		μs		
Output Hi-Z releasing voltage	V_{RE}		2.9		V	When power is on, output is released Hi-Z.	(*2)
Thermal-shutdown operating temp.	TSD_{ON}	185	205	225	$^{\circ}C$	T_j of Internal temp. sensor	(*3)
Thermal-shutdown releasing temp.	TSD_{OFF}	175	195	215	$^{\circ}C$	T_j of Internal temp. sensor	(*3)

*2. Output waveform in power on

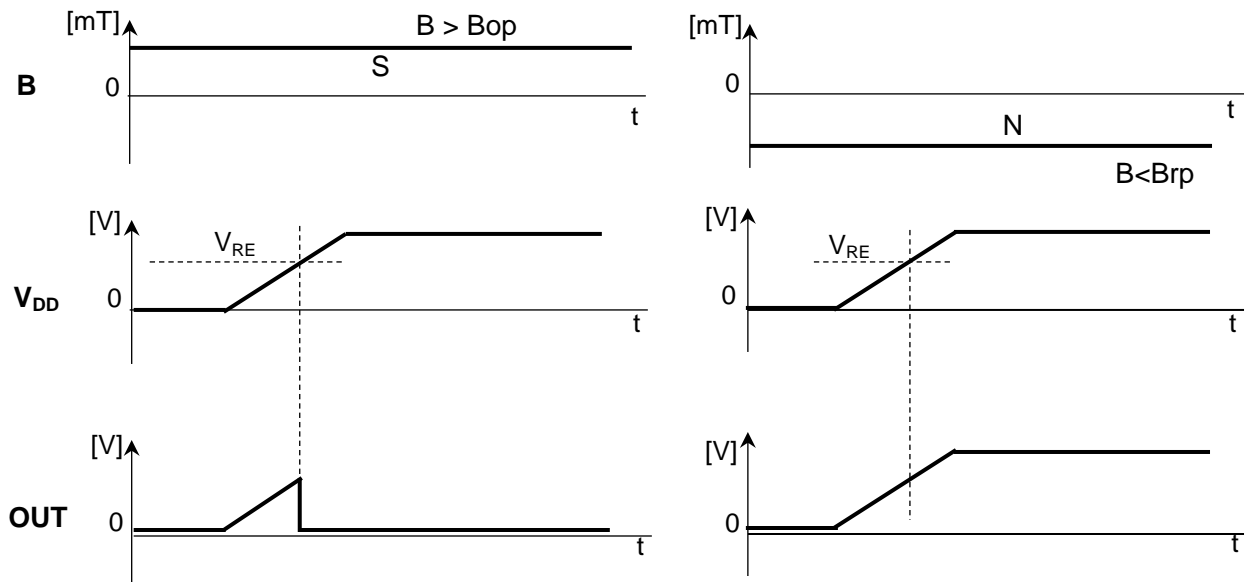


Figure 4. Output waveform in power on

*3. When T_j is beyond TSD_{ON} , the output turns off. And the output current is shut off. When T_j is below TSD_{OFF} , the output operates by magnetic field again.

9. Magnetic Characteristics

Table 6. Magnetic characteristics at $V_{DD} = 3.8$ to $24V$, $T_a = -40$ to $150^{\circ}C$ (Typ. $T_a = 25^{\circ}C$, $V_{DD} = 12V$)

Parameter	Symbol	Min.	Typ.	Max.	Unit	Description
Operate point	Bop	1.0	2.0	3.0	mT	
Release point	Brp	-3.0	-2.0	-1.0	mT	
Hysteresis	Bh	2.3	4.0	5.7	mT	$B_h = B_{op} - B_{rp}$
Magnetic offset	Boff	-0.6	0.0	+0.6	mT	$B_{off} = (B_{op} + B_{rp}) / 2$

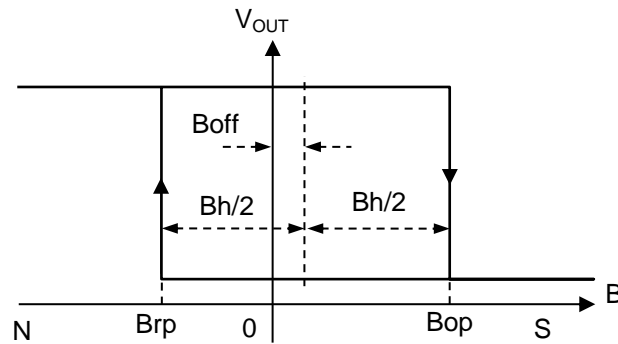


Figure 5. Magnetic Characteristics

10. Operating Characteristics

10.1. Definition of Magnetic Field

The OUT signal switches 'L' (ON) when the magnetic field perpendicular to the marking side of the package exceeds B_{op} . When the magnetic field is reduced below B_{rp} , the OUT goes 'H' (OFF). In case of the magnetic field strength is greater than B_{rp} , and smaller than B_{op} , OUT keeps its status.

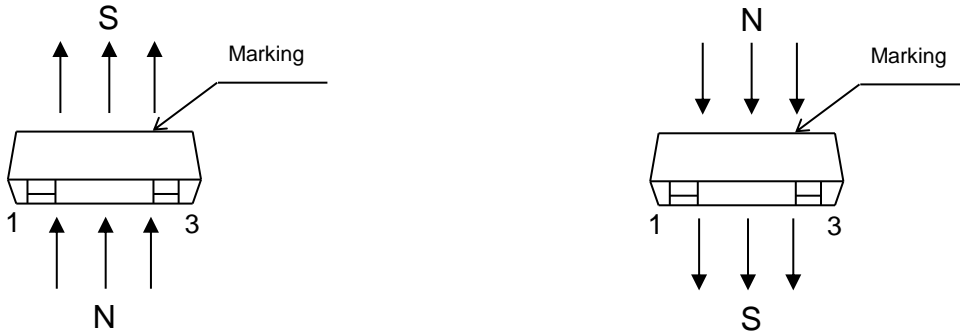


Figure 6. Definition of magnetic field

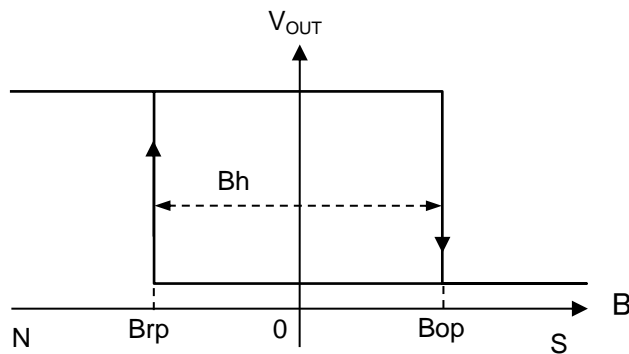


Figure 7. Switching behavior of OUT signal when magnetic field is applied

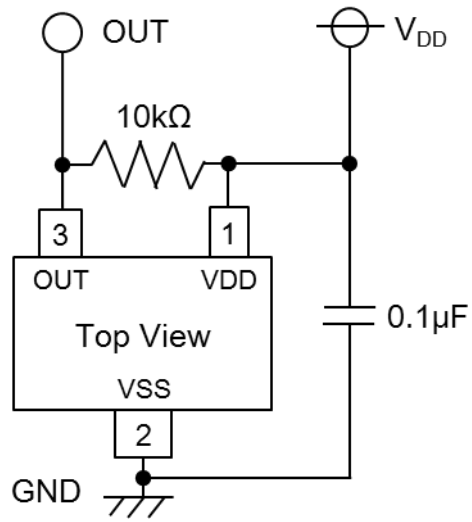
11. Recommended External Circuit

Figure 8. Recommended External Circuit

12. Typical Characteristics Data (for reference)

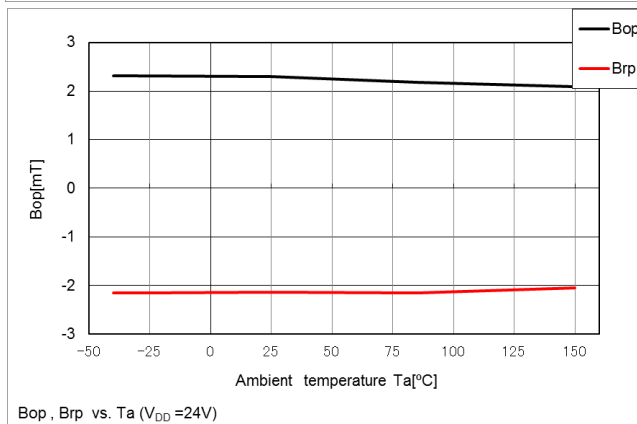
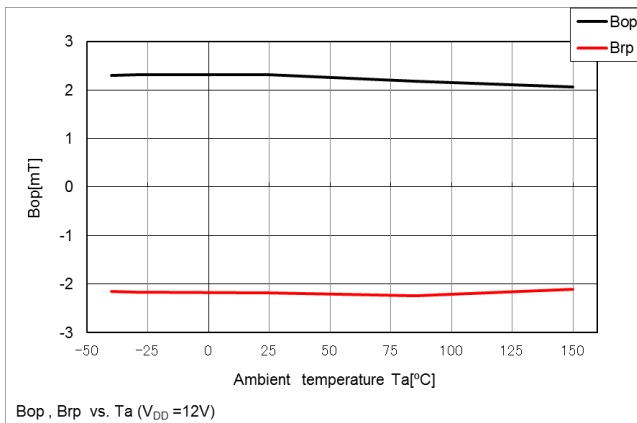
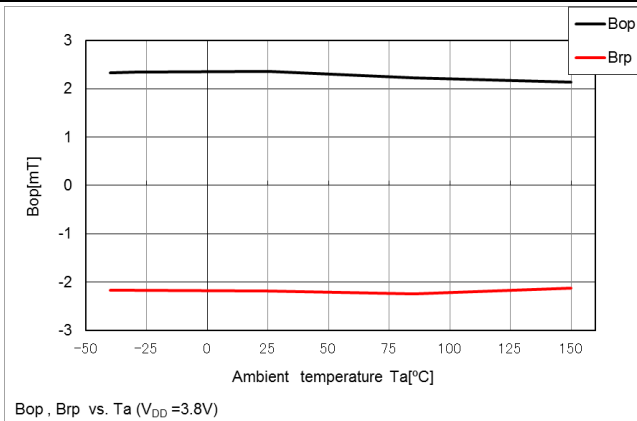


Figure 9. Temperature Dependence of Bop, Brp

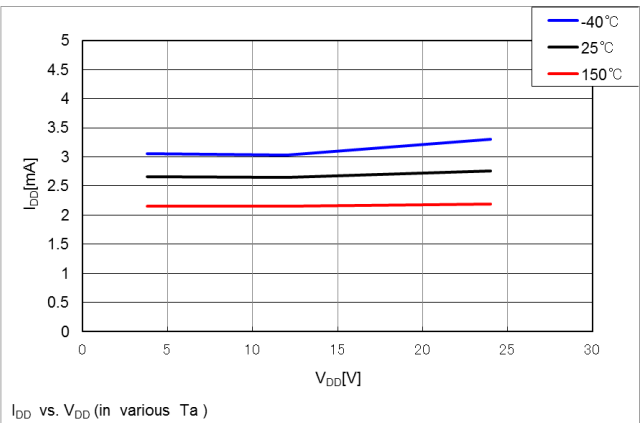
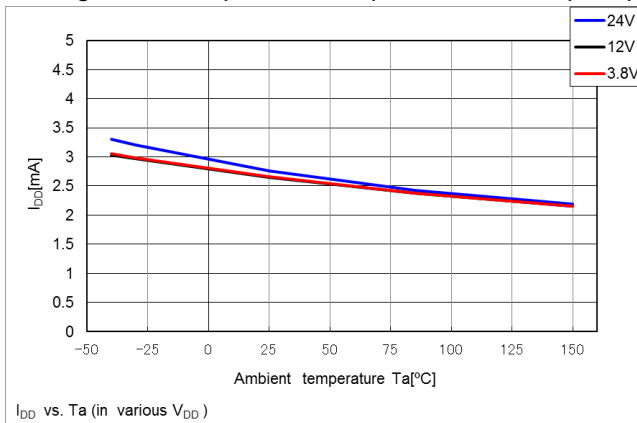


Figure 10. Temperature Dependence of Current Consumption

13. Package

13.1.Outline Dimensions

3-pin SOP (Unit: mm)

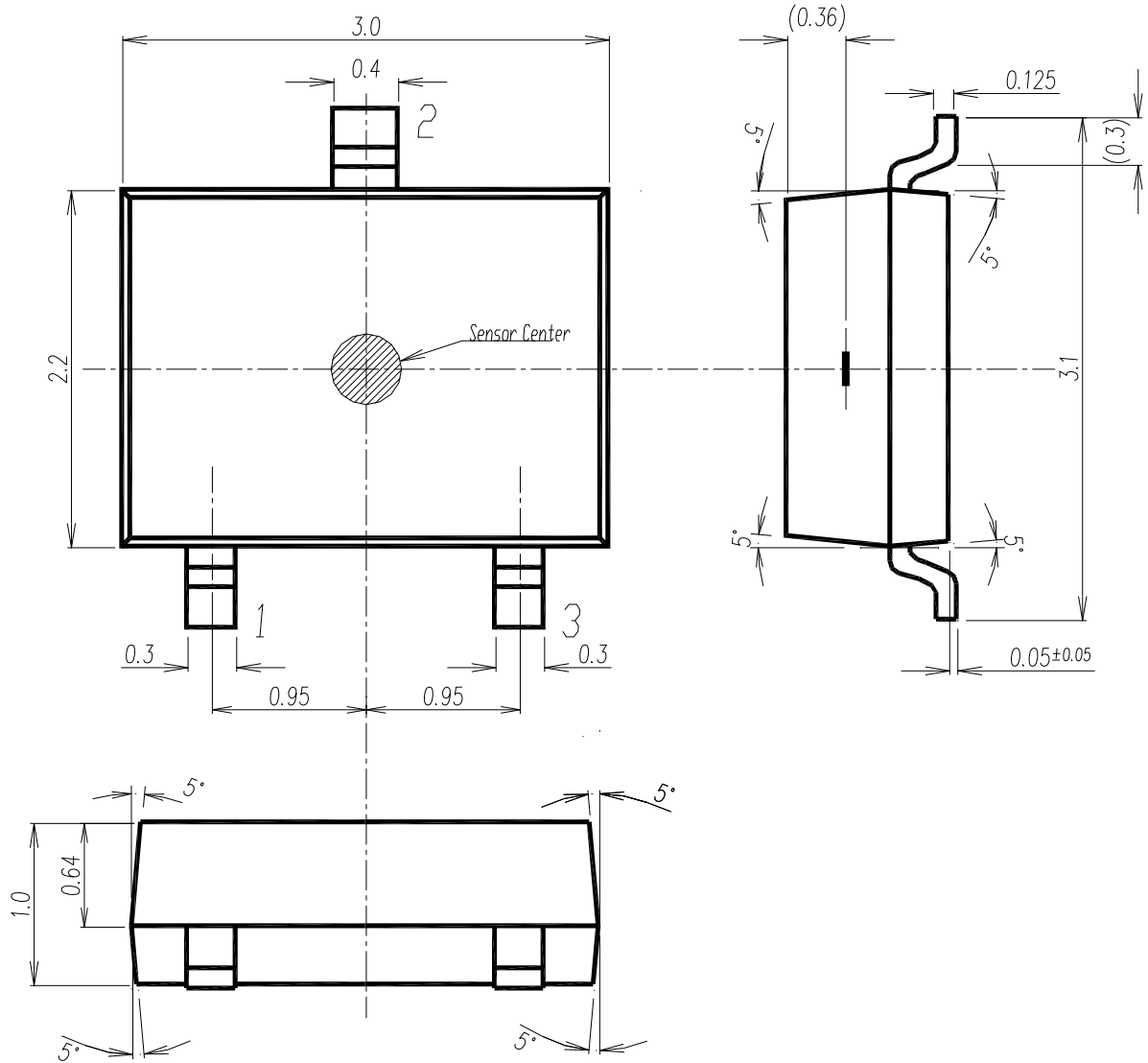


Figure 11. Outline Dimensions

- * The center of the sensitive are is located within a $\phi 0.3\text{mm}$ circle.
- * The tolerances of dimensions with no mentions is $\pm 0.1\text{mm}$.
- * Lead flatness: The standoff differences among terminals are Max. 0.1mm.
- * The sensor part is located at 0.36mm (Typ.) deep from the marked surface.

13.2.Material of Terminals

Material: Cu alloy
 Plating: Sn-2.0Bi
 Thickness: 10 μm (Typ.)

13.3.Land Pattern

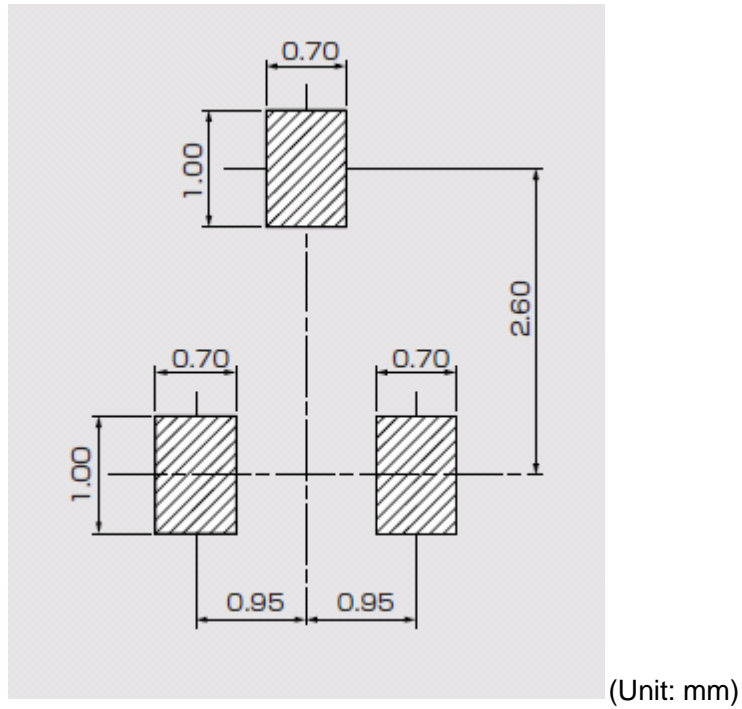
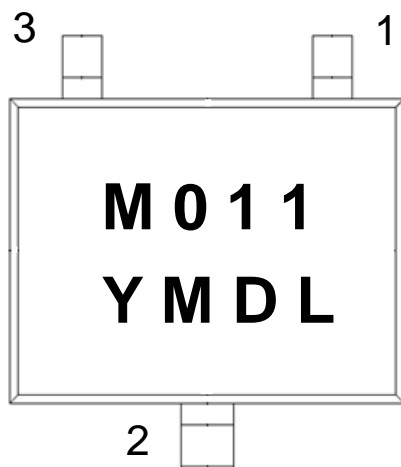


Figure 12. Land Pattern

13.4.Marking



Marking is performed by laser.

Product name	M011(EM6011)
Date code	YMDL
	Y: Manufactured Year
	M: Manufactured Month
	D: Manufactured Day
	L: Lot Number

Figure 13. Marking

IMPORTANT NOTICE

0. Asahi Kasei Microdevices Corporation ("AKM") reserves the right to make changes to the information contained in this document without notice. When you consider any use or application of AKM product stipulated in this document ("Product"), please make inquiries the sales office of AKM or authorized distributors as to current status of the Products.
1. All information included in this document are provided only to illustrate the operation and application examples of AKM Products. AKM neither makes warranties or representations with respect to the accuracy or completeness of the information contained in this document nor grants any license to any intellectual property rights or any other rights of AKM or any third party with respect to the information in this document. You are fully responsible for use of such information contained in this document in your product design or applications. **AKM ASSUMES NO LIABILITY FOR ANY LOSSES INCURRED BY YOU OR THIRD PARTIES ARISING FROM THE USE OF SUCH INFORMATION IN YOUR PRODUCT DESIGN OR APPLICATIONS.**
2. The Product is neither intended nor warranted for use in equipment or systems that require extraordinarily high levels of quality and/or reliability and/or a malfunction or failure of which may cause loss of human life, bodily injury, serious property damage or serious public impact, including but not limited to, equipment used in nuclear facilities, equipment used in the aerospace industry, medical equipment, equipment used for automobiles, trains, ships and other transportation, traffic signaling equipment, equipment used to control combustions or explosions, safety devices, elevators and escalators, devices related to electric power, and equipment used in finance-related fields. Do not use Product for the above use unless specifically agreed by AKM in writing.
3. Though AKM works continually to improve the Product's quality and reliability, you are responsible for complying with safety standards and for providing adequate designs and safeguards for your hardware, software and systems which minimize risk and avoid situations in which a malfunction or failure of the Product could cause loss of human life, bodily injury or damage to property, including data loss or corruption.
4. Do not use or otherwise make available the Product or related technology or any information contained in this document for any military purposes, including without limitation, for the design, development, use, stockpiling or manufacturing of nuclear, chemical, or biological weapons or missile technology products (mass destruction weapons). When exporting the Products or related technology or any information contained in this document, you should comply with the applicable export control laws and regulations and follow the procedures required by such laws and regulations. The Products and related technology may not be used for or incorporated into any products or systems whose manufacture, use, or sale is prohibited under any applicable domestic or foreign laws or regulations.
5. Please contact AKM sales representative for details as to environmental matters such as the RoHS compatibility of the Product. Please use the Product in compliance with all applicable laws and regulations that regulate the inclusion or use of controlled substances, including without limitation, the EU RoHS Directive. AKM assumes no liability for damages or losses occurring as a result of noncompliance with applicable laws and regulations.
6. Resale of the Product with provisions different from the statement and/or technical features set forth in this document shall immediately void any warranty granted by AKM for the Product and shall not create or extend in any manner whatsoever, any liability of AKM.
7. This document may not be reproduced or duplicated, in any form, in whole or in part, without prior written consent of AKM.

Rev.1