

JFET VHF/UHF Amplifiers

N-Channel — Depletion

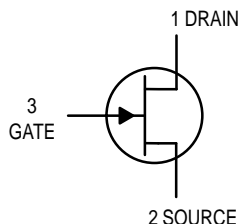

2N5484
2N5486

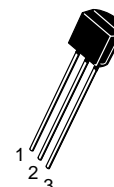

CASE 29-04, STYLE 5
TO-92 (TO-226AA)

MAXIMUM RATINGS

| Rating | Symbol | Value | Unit |
|--|----------------|-------------|----------------------------|
| Drain–Gate Voltage | V_{DG} | 25 | Vdc |
| Reverse Gate–Source Voltage | V_{GSR} | 25 | Vdc |
| Drain Current | I_D | 30 | mAdc |
| Forward Gate Current | $I_{G(f)}$ | 10 | mAdc |
| Total Device Dissipation @ $T_C = 25^\circ\text{C}$ Derate above 25°C | P_D | 350 2.8 | mW mW/ $^\circ\text{C}$ |
| Operating and Storage Junction Temperature Range | T_J, T_{stg} | -65 to +150 | $^\circ\text{C}$ |

ELECTRICAL CHARACTERISTICS ($T_A = 25^\circ\text{C}$ unless otherwise noted)

| Characteristic | Symbol | Min | Typ | Max | Unit |
|----------------|--------|-----|-----|-----|------|
|----------------|--------|-----|-----|-----|------|

OFF CHARACTERISTICS

| | | | | | | |
|--|---------------|------------------|--------------|--------------|-------------------------|-----|
| Gate–Source Breakdown Voltage ($I_G = -1.0 \mu\text{Adc}$, $V_{DS} = 0$) | $V_{(BR)GSS}$ | -25 | — | — | Vdc | |
| Gate Reverse Current ($V_{GS} = -20 \text{ Vdc}$, $V_{DS} = 0$) ($V_{GS} = -20 \text{ Vdc}$, $V_{DS} = 0$, $T_A = 100^\circ\text{C}$) | I_{GSS} | — — | — — | -1.0 -0.2 | nAdc μAdc | |
| Gate Source Cutoff Voltage ($V_{DS} = 15 \text{ Vdc}$, $I_D = 10 \text{ nAdc}$) | $V_{GS(off)}$ | 2N5484 2N5486 | -0.3 -2.0 | — — | -3.0 -6.0 | Vdc |

ON CHARACTERISTICS

| | | | | | | |
|---|-----------|------------------|------------|--------|-----------|------|
| Zero–Gate–Voltage Drain Current ($V_{DS} = 15 \text{ Vdc}$, $V_{GS} = 0$) | I_{DSS} | 2N5484 2N5486 | 1.0 8.0 | — — | 5.0 20 | mAdc |
|---|-----------|------------------|------------|--------|-----------|------|

SMALL–SIGNAL CHARACTERISTICS

| | | | | | | |
|--|---------------------|------------------|--------------|--------|--------------|-----------------|
| Forward Transfer Admittance ($V_{DS} = 15 \text{ Vdc}$, $V_{GS} = 0$, $f = 1.0 \text{ kHz}$) | $ y_{fs} $ | 2N5484 2N5486 | 3000 4000 | — — | 6000 8000 | μhos |
| Input Admittance ($V_{DS} = 15 \text{ Vdc}$, $V_{GS} = 0$, $f = 100 \text{ MHz}$) ($V_{DS} = 15 \text{ Vdc}$, $V_{GS} = 0$, $f = 400 \text{ MHz}$) | $\text{Re}(y_{is})$ | 2N5484 2N5486 | — — | — — | 100 1000 | μhos |
| Output Admittance ($V_{DS} = 15 \text{ Vdc}$, $V_{GS} = 0$, $f = 1.0 \text{ kHz}$) | $ y_{os} $ | 2N5484 2N5486 | — — | — — | 50 75 | μhos |
| Output Conductance ($V_{DS} = 15 \text{ Vdc}$, $V_{GS} = 0$, $f = 100 \text{ MHz}$) ($V_{DS} = 15 \text{ Vdc}$, $V_{GS} = 0$, $f = 400 \text{ MHz}$) | $\text{Re}(y_{os})$ | 2N5484 2N5486 | — — | — — | 75 100 | μhos |
| Forward Transconductance ($V_{DS} = 15 \text{ Vdc}$, $V_{GS} = 0$, $f = 100 \text{ MHz}$) ($V_{DS} = 15 \text{ Vdc}$, $V_{GS} = 0$, $f = 400 \text{ MHz}$) | $\text{Re}(y_{fs})$ | 2N5484 2N5486 | 2500 3500 | — — | — — | μhos |

ELECTRICAL CHARACTERISTICS ($T_A = 25^\circ\text{C}$ unless otherwise noted) (Continued)

| Characteristic | Symbol | Min | Typ | Max | Unit |
|--|-----------|-----|-----|-----|------|
| SMALL-SIGNAL CHARACTERISTICS (continued) | | | | | |
| Input Capacitance ($V_{DS} = 15\text{ Vdc}$, $V_{GS} = 0$, $f = 1.0\text{ MHz}$) | C_{iss} | — | — | 5.0 | pF |
| Reverse Transfer Capacitance ($V_{DS} = 15\text{ Vdc}$, $V_{GS} = 0$, $f = 1.0\text{ MHz}$) | C_{rss} | — | — | 1.0 | pF |
| Output Capacitance ($V_{DS} = 15\text{ Vdc}$, $V_{GS} = 0$, $f = 1.0\text{ MHz}$) | C_{oss} | — | — | 2.0 | pF |

FUNCTIONAL CHARACTERISTICS

| | | | | | | |
|--|--|----------|----|----|-----|----|
| Noise Figure ($V_{DS} = 15\text{ Vdc}$, $V_{GS} = 0$, $R_G = 1.0\text{ Megohm}$, $f = 1.0\text{ kHz}$) ($V_{DS} = 15\text{ Vdc}$, $I_D = 1.0\text{ mAdc}$, $R_G \approx 1.0\text{ k}\Omega$, $f = 100\text{ MHz}$) ($V_{DS} = 15\text{ Vdc}$, $I_D = 1.0\text{ mAdc}$, $R_G \approx 1.0\text{ k}\Omega$, $f = 200\text{ MHz}$) ($V_{DS} = 15\text{ Vdc}$, $I_D = 4.0\text{ mAdc}$, $R_G \approx 1.0\text{ k}\Omega$, $f = 100\text{ MHz}$) ($V_{DS} = 15\text{ Vdc}$, $I_D = 4.0\text{ mAdc}$, $R_G \approx 1.0\text{ k}\Omega$, $f = 400\text{ MHz}$) | 2N5484 2N5484 2N5486 2N5486 | NF | — | — | 2.5 | dB |
| Common Source Power Gain ($V_{DS} = 15\text{ Vdc}$, $I_D = 1.0\text{ mAdc}$, $f = 100\text{ MHz}$) ($V_{DS} = 15\text{ Vdc}$, $I_D = 1.0\text{ mAdc}$, $f = 200\text{ MHz}$) ($V_{DS} = 15\text{ Vdc}$, $I_D = 4.0\text{ mAdc}$, $f = 100\text{ MHz}$) ($V_{DS} = 15\text{ Vdc}$, $I_D = 4.0\text{ mAdc}$, $f = 400\text{ MHz}$) | 2N5484 2N5484 2N5486 2N5486 | G_{ps} | 16 | — | 25 | dB |
| | | | — | 14 | — | |
| | | | 18 | — | 30 | |
| | | | 10 | — | 20 | |

POWER GAIN

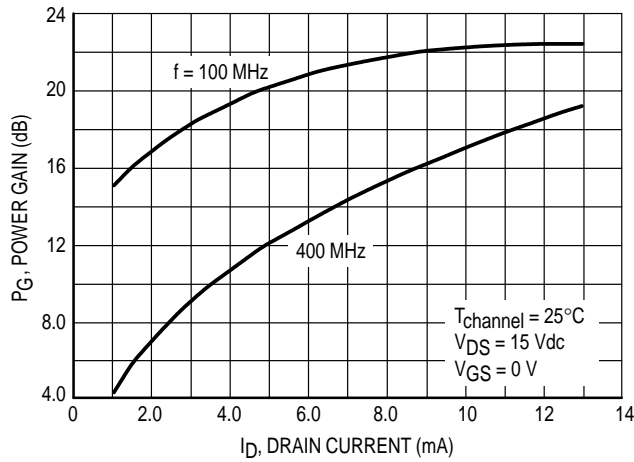
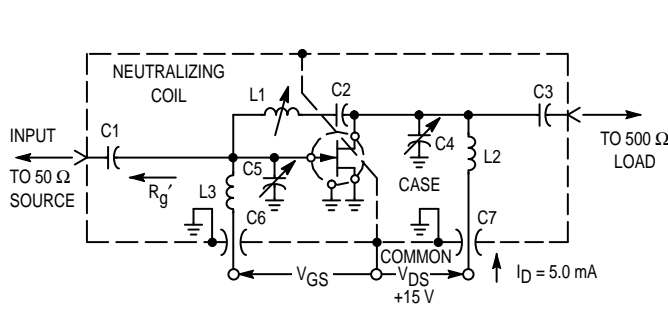

Figure 1. Effects of Drain Current



Adjust V_{GS} for
 $I_D = 5.0 \text{ mA}$
 $V_{GS} < 0 \text{ Volts}$

NOTE: The noise source is a hot-cold body (AIL type 70 or equivalent) with a test receiver (AIL type 136 or equivalent).

| Reference Designation | VALUE | |
|-----------------------|----------------------|--------------------------|
| | 100 MHz | 400 MHz |
| C1 | 7.0 pF | 1.8 pF |
| C2 | 1000 pF | 17 pF |
| C3 | 3.0 pF | 1.0 pF |
| C4 | 1–12 pF | 0.8–8.0 pF |
| C5 | 1–12 pF | 0.8–8.0 pF |
| C6 | 0.0015 μF | 0.001 μF |
| C7 | 0.0015 μF | 0.001 μF |
| L1 | 3.0 μH^* | 0.2 μH^{**} |
| L2 | 0.15 μH^* | 0.03 μH^{**} |
| L3 | 0.14 μH^* | 0.022 μH^{**} |

- *L1 17 turns, (approx. — depends upon circuit layout) AWG #28 enameled copper wire, close wound on 9/32" ceramic coil form. Tuning provided by a powdered iron slug.
- L2 4–1/2 turns, AWG #18 enameled copper wire, 5/16" long, 3/8" I.D. (AIR CORE).
- L3 3–1/2 turns, AWG #18 enameled copper wire, 1/4" long, 3/8" I.D. (AIR CORE).

- **L1 6 turns, (approx. — depends upon circuit layout) AWG #24 enameled copper wire, close wound on 7/32" ceramic coil form. Tuning provided by an aluminum slug.
- L2 1 turn, AWG #16 enameled copper wire, 3/8" I.D. (AIR CORE).
- L3 1/2 turn, AWG #16 enameled copper wire, 1/4" I.D. (AIR CORE).

Figure 2. 100 MHz and 400 MHz Neutralized Test Circuit

NOISE FIGURE
 $(T_{\text{channel}} = 25^\circ\text{C})$

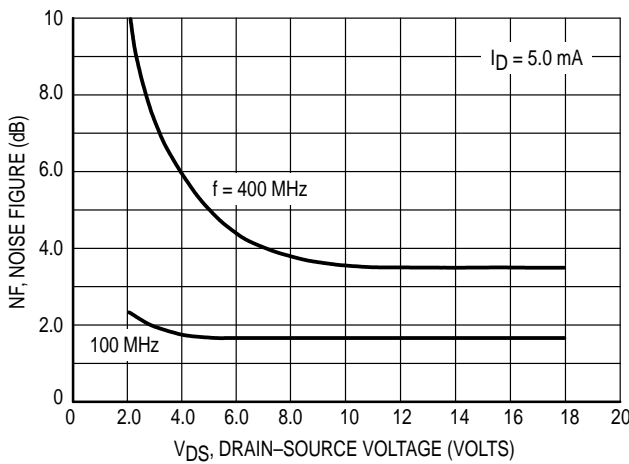

Figure 3. Effects of Drain-Source Voltage

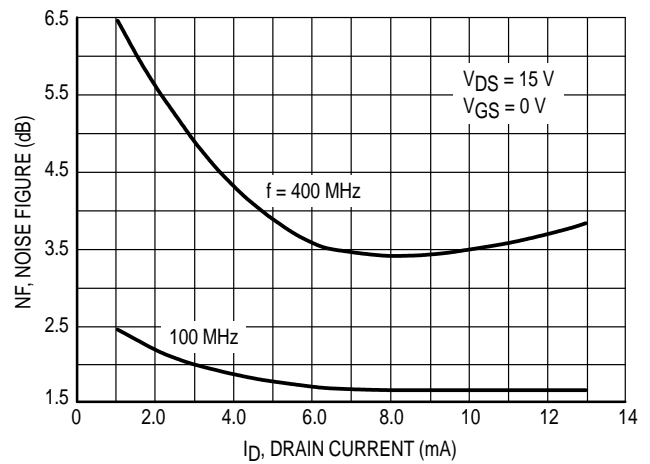

Figure 4. Effects of Drain Current

INTERMODULATION CHARACTERISTICS

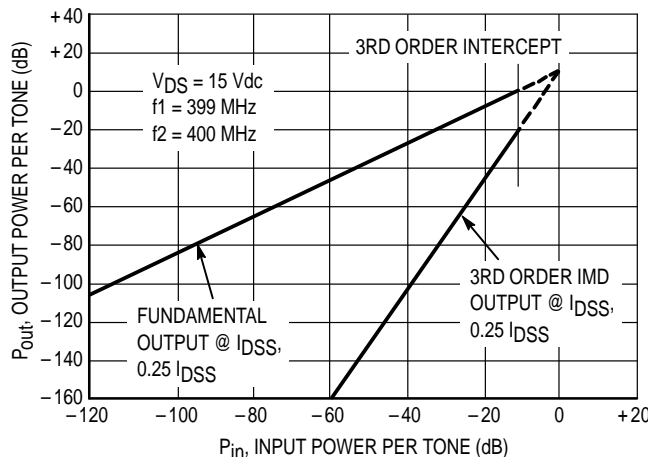

Figure 5. Third Order Intermodulation Distortion

COMMON SOURCE CHARACTERISTICS
ADMITTANCE PARAMETERS
 (V_{DS} = 15 Vdc, T_{channel} = 25°C)

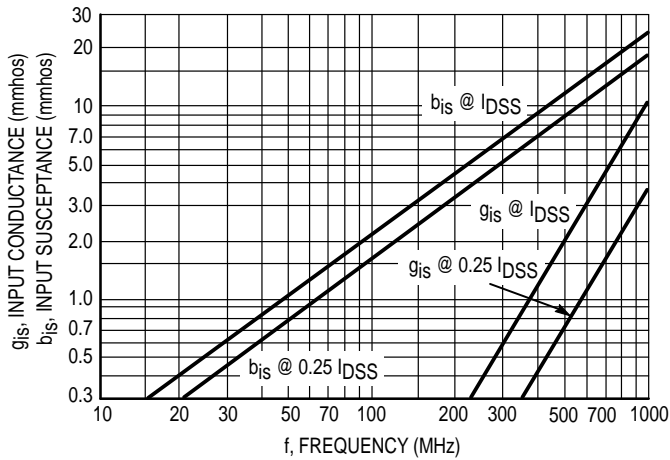

Figure 6. Input Admittance (y_{is})

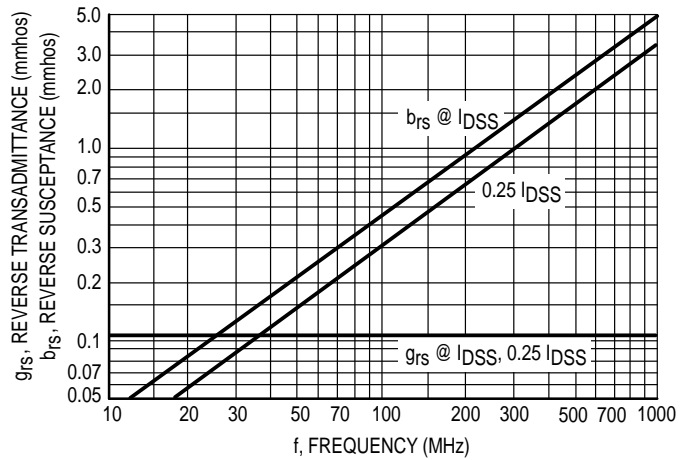

Figure 7. Reverse Transfer Admittance (y_{rs})

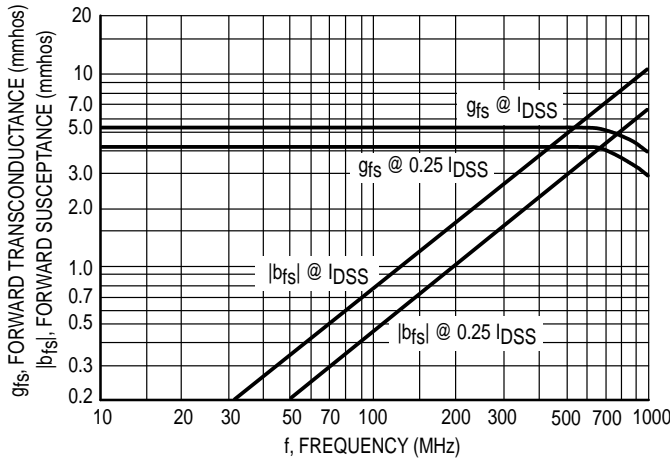

Figure 8. Forward Transadmittance (y_{fs})

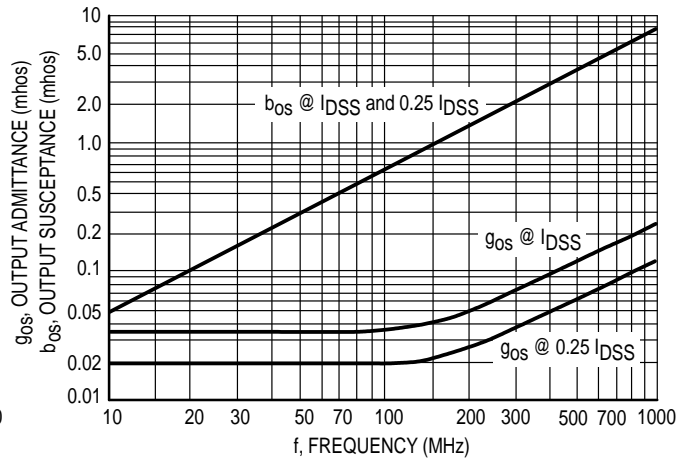

Figure 9. Output Admittance (y_{os})

COMMON SOURCE CHARACTERISTICS
S-PARAMETERS
 ($V_{DS} = 15 \text{ Vdc}$, $T_{\text{channel}} = 25^\circ\text{C}$, Data Points in MHz)

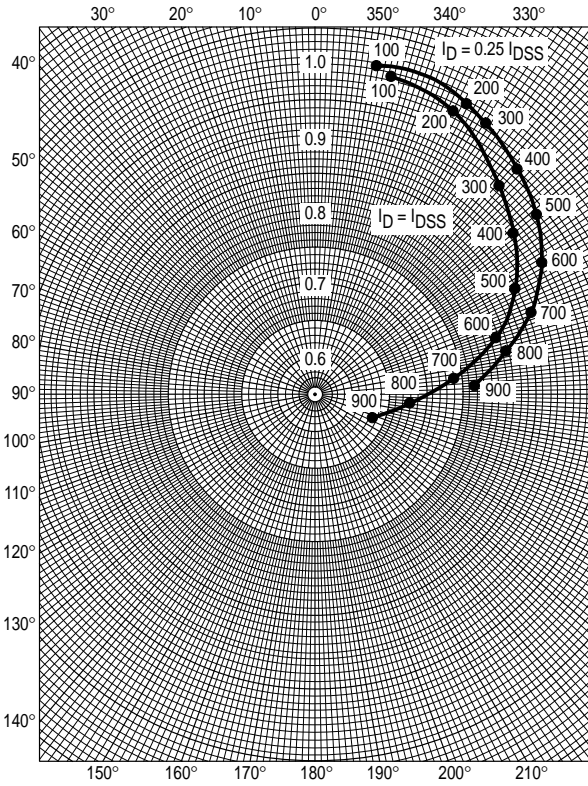

Figure 10. S_{11s}

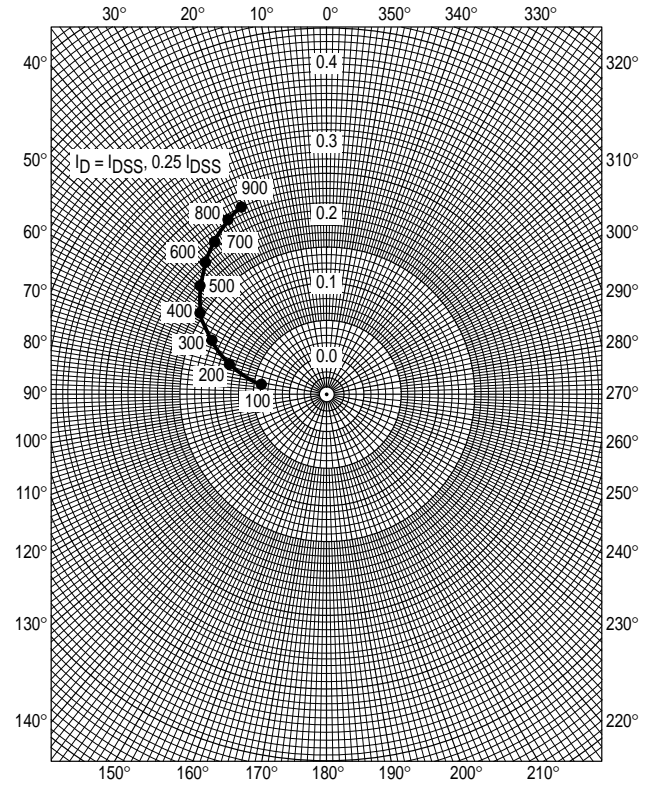

Figure 11. S_{12s}

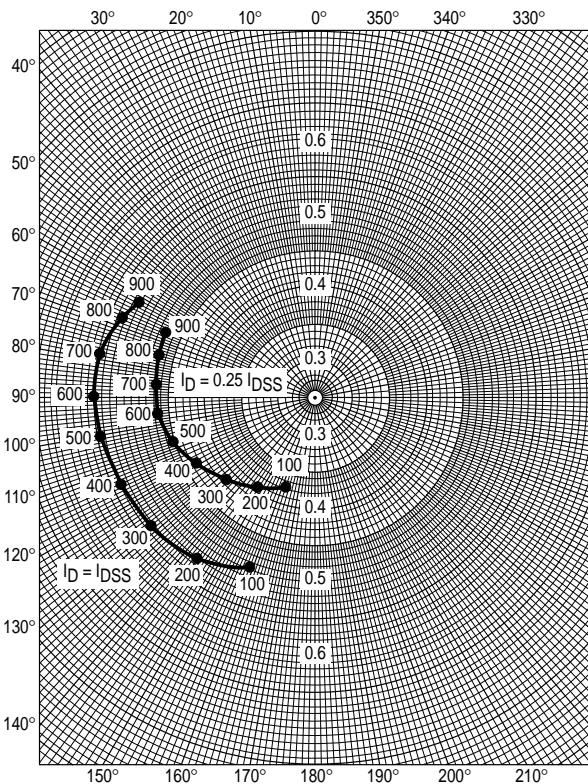

Figure 12. S_{21s}

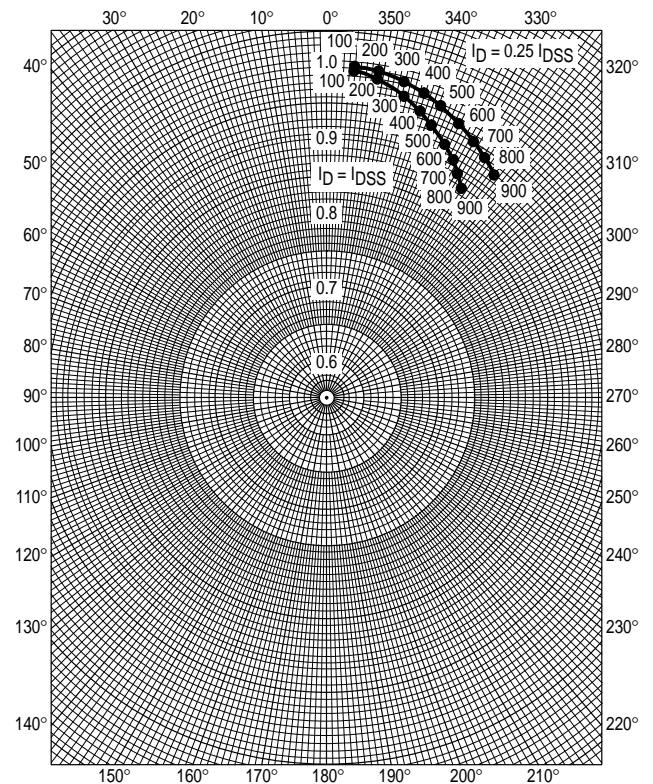

Figure 13. S_{22s}

COMMON GATE CHARACTERISTICS

ADMITTANCE PARAMETERS

(VDG = 15 Vdc, Tchannel = 25°C)

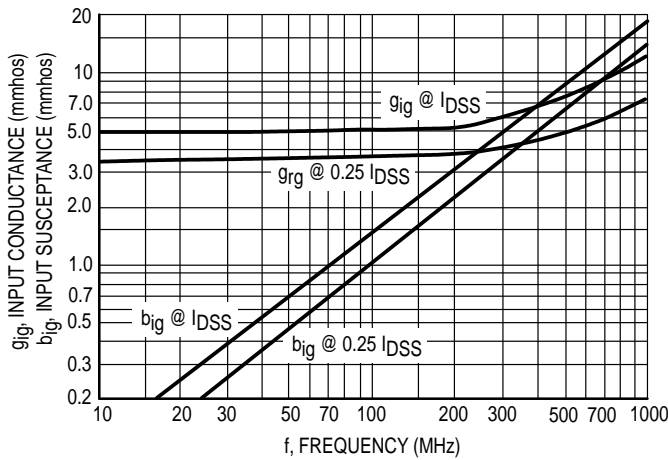

Figure 14. Input Admittance (y_{ig})

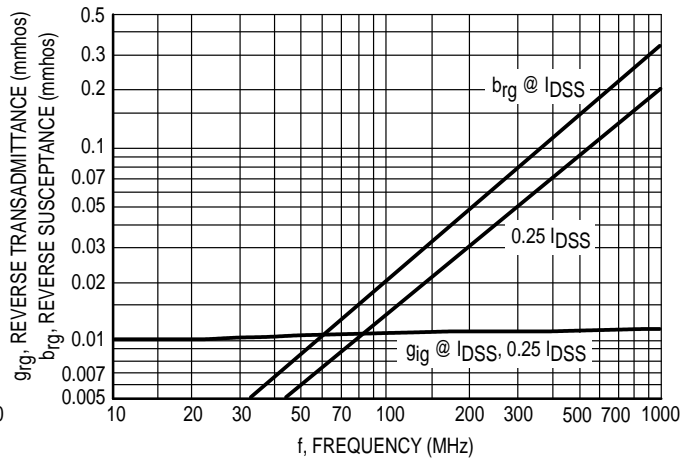

Figure 15. Reverse Transfer Admittance (y_{rg})

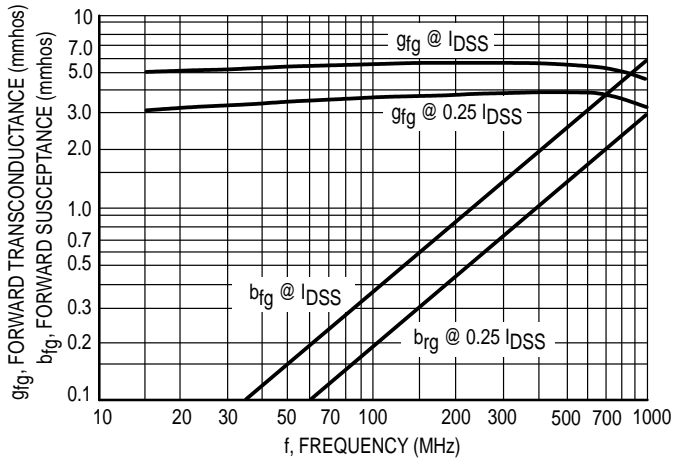

Figure 16. Forward Transfer Admittance (y_{fg})

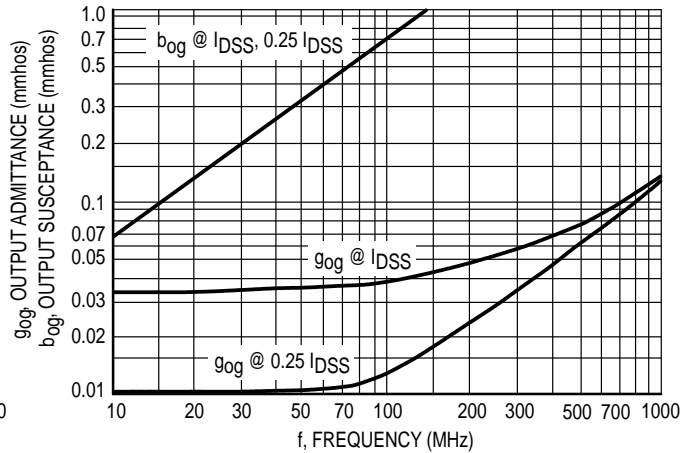

Figure 17. Output Admittance (y_{og})

COMMON GATE CHARACTERISTICS
S-PARAMETERS

($V_{DS} = 15 \text{ Vdc}$, $T_{\text{channel}} = 25^\circ\text{C}$, Data Points in MHz)

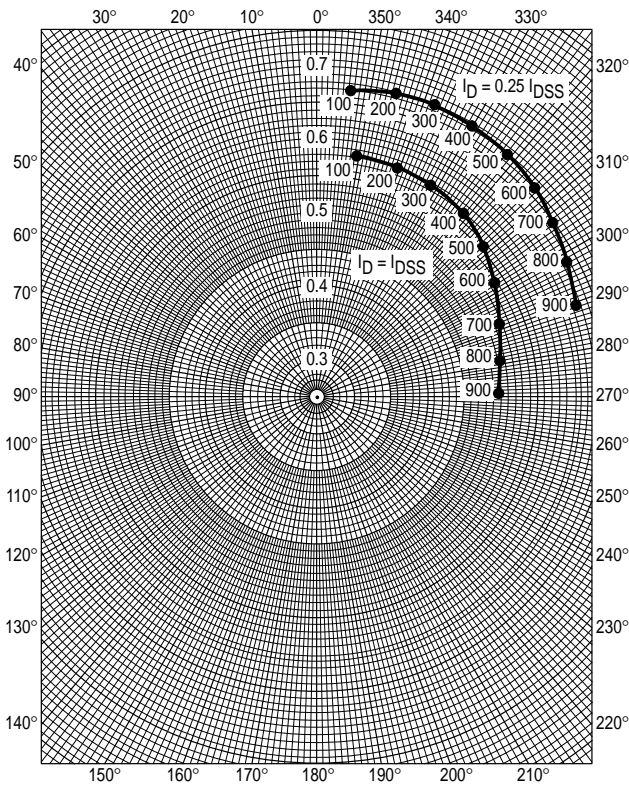

Figure 18. S_{11g}

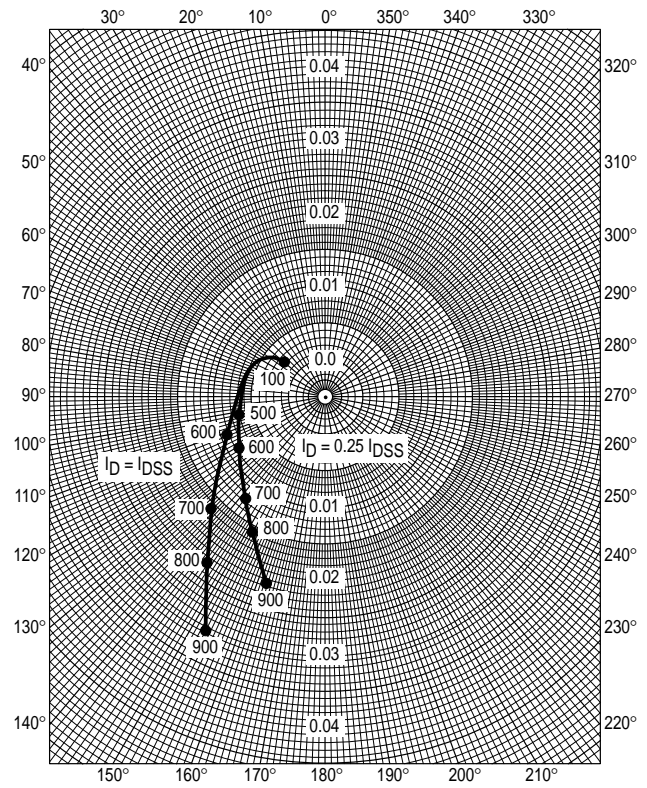

Figure 19. S_{12g}

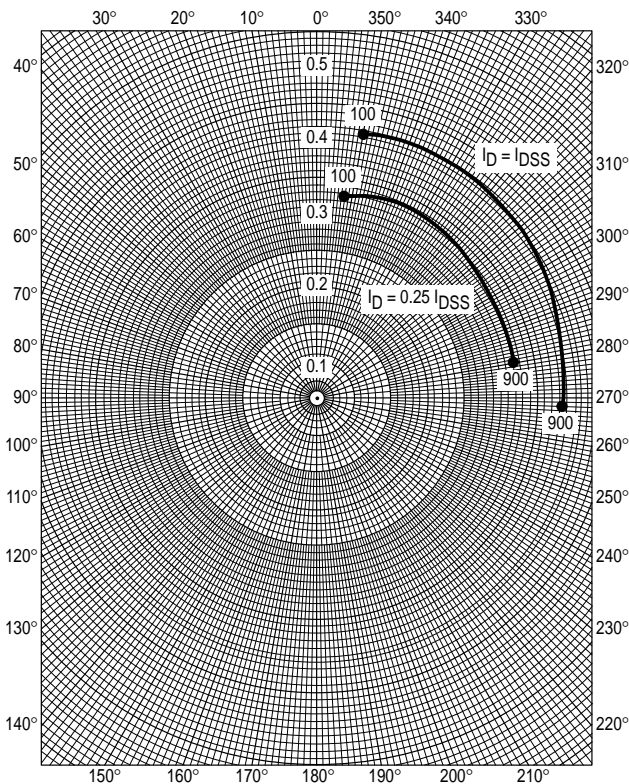

Figure 20. S_{21g}

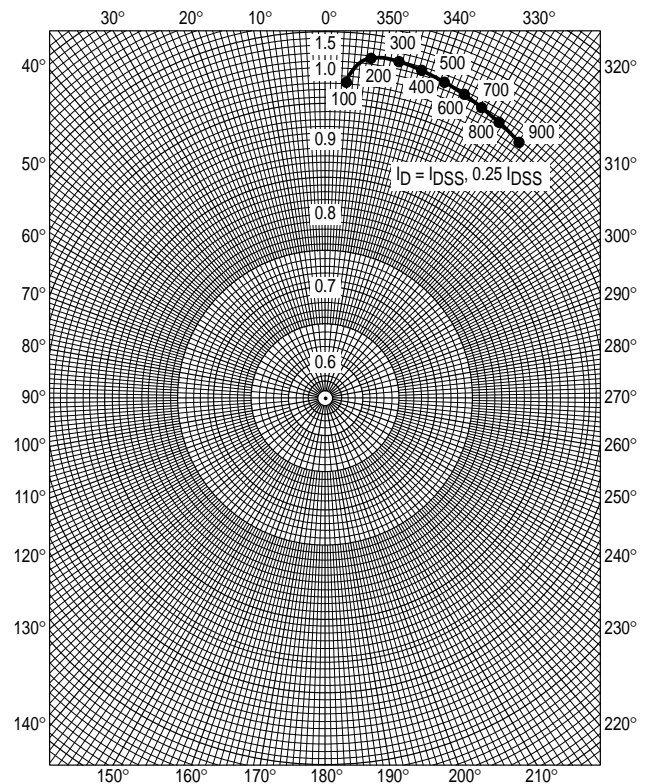
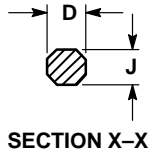
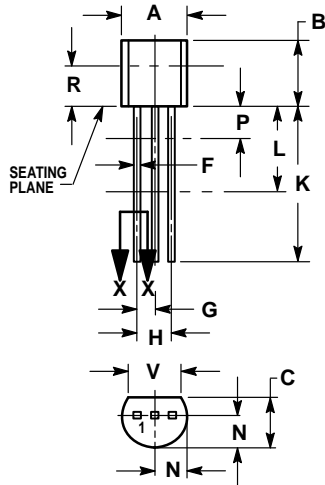

Figure 21. S_{22g}

PACKAGE DIMENSIONS



NOTES:

1. DIMENSIONING AND TOLERANCING PER ANSI Y14.5M, 1982.
2. CONTROLLING DIMENSION: INCH.
3. CONTOUR OF PACKAGE BEYOND DIMENSION R IS UNCONTROLLED.
4. DIMENSION F APPLIES BETWEEN P AND L. DIMENSION D AND J APPLY BETWEEN L AND K. MINIMUM. LEAD DIMENSION IS UNCONTROLLED IN P AND BEYOND DIMENSION K MINIMUM.

| DIM | INCHES | | MILLIMETERS | |
|-----|--------|-------|-------------|------|
| | MIN | MAX | MIN | MAX |
| A | 0.175 | 0.205 | 4.45 | 5.20 |
| B | 0.170 | 0.210 | 4.32 | 5.33 |
| C | 0.125 | 0.165 | 3.18 | 4.19 |
| D | 0.016 | 0.022 | 0.41 | 0.55 |
| F | 0.016 | 0.019 | 0.41 | 0.48 |
| G | 0.045 | 0.055 | 1.15 | 1.39 |
| H | 0.095 | 0.105 | 2.42 | 2.66 |
| J | 0.015 | 0.020 | 0.39 | 0.50 |
| K | 0.500 | — | 12.70 | — |
| L | 0.250 | — | 6.35 | — |
| N | 0.080 | 0.105 | 2.04 | 2.66 |
| P | — | 0.100 | — | 2.54 |
| R | 0.115 | — | 2.93 | — |
| V | 0.135 | — | 3.43 | — |

CASE 029-04
(TO-226AA)
ISSUE AD

STYLE 5:

- PIN 1. DRAIN
2. SOURCE
3. GATE

Motorola reserves the right to make changes without further notice to any products herein. Motorola makes no warranty, representation or guarantee regarding the suitability of its products for any particular purpose, nor does Motorola assume any liability arising out of the application or use of any product or circuit, and specifically disclaims any and all liability, including without limitation consequential or incidental damages. "Typical" parameters which may be provided in Motorola data sheets and/or specifications can and do vary in different applications and actual performance may vary over time. All operating parameters, including "Typicals" must be validated for each customer application by customer's technical experts. Motorola does not convey any license under its patent rights nor the rights of others. Motorola products are not designed, intended, or authorized for use as components in systems intended for surgical implant into the body, or other applications intended to support or sustain life, or for any other application in which the failure of the Motorola product could create a situation where personal injury or death may occur. Should Buyer purchase or use Motorola products for any such unintended or unauthorized application, Buyer shall indemnify and hold Motorola and its officers, employees, subsidiaries, affiliates, and distributors harmless against all claims, costs, damages, and expenses, and reasonable attorney fees arising out of, directly or indirectly, any claim of personal injury or death associated with such unintended or unauthorized use, even if such claim alleges that Motorola was negligent regarding the design or manufacture of the part. Motorola and are registered trademarks of Motorola, Inc. Motorola, Inc. is an Equal Opportunity/Affirmative Action Employer.

Mfax is a trademark of Motorola, Inc.

How to reach us:

USA/EUROPE/Locations Not Listed: Motorola Literature Distribution;
P.O. Box 5405, Denver, Colorado 80217. 303-675-2140 or 1-800-441-2447

JAPAN: Nippon Motorola Ltd.; Tatsumi-SPD-JLDC, 6F Seibu-Butsuryu-Center,
3-14-2 Tatsumi Koto-Ku, Tokyo 135, Japan. 81-3-3521-8315

Mfax™: RMFAX0@email.sps.mot.com – TOUCHTONE 602-244-6609
– US & Canada ONLY 1-800-774-1848

ASIA/PACIFIC: Motorola Semiconductors H.K. Ltd.; 8B Tai Ping Industrial Park,
51 Ting Kok Road, Tai Po, N.T., Hong Kong. 852-26629298

INTERNET: <http://motorola.com/sps>

