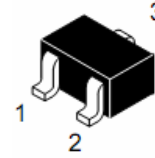
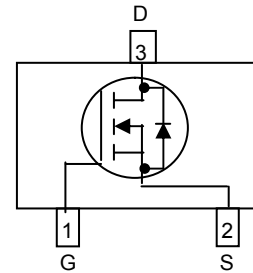
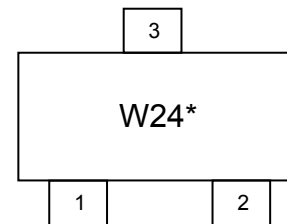

WNM2024
Single N-Channel, 20V, 3.9A, Power MOSFET
[Http://www.sh-willsemi.com](http://www.sh-willsemi.com)

V _{DS} (V)	R _{ds(on)} (Ω)
20	0.027@ V _{GS} =4.5V
	0.031@ V _{GS} =2.5V
	0.036@ V _{GS} =1.8V

SOT-23
Descriptions

The WNM2024 is N-Channel enhancement MOS Field Effect Transistor. Uses advanced trench technology and design to provide excellent R_{DS(ON)} with low gate charge. This device is suitable for use in DC-DC conversion, power switch and charging circuit. Standard Product WNM2024 is Pb-free and Halogen-free.

Pin configuration (Top view)

W24= Device Code

* = Month (A~Z)

Marking
Features

- Trench Technology
- Supper high density cell design
- Excellent ON resistance for higher DC current
- Extremely Low Threshold Voltage
- Small package SOT-23

Applications

- Driver for Relay, Solenoid, Motor, LED etc.
- DC-DC converter circuit
- Power Switch
- Load Switch
- Charging

Order information

Device	Package	Shipping
WNM2024-3/TR	SOT-23	3000/Reel&Tape

Absolute Maximum ratings

Parameter		Symbol	10 S	Steady State	Unit
Drain-Source Voltage		V_{DS}	20		V
Gate-Source Voltage		V_{GS}	± 8		
Continuous Drain Current ^a	$T_A=25^\circ\text{C}$	I_D	3.9	3.6	A
	$T_A=70^\circ\text{C}$		3.1	2.9	
Maximum Power Dissipation ^a	$T_A=25^\circ\text{C}$	P_D	0.8	0.7	W
	$T_A=70^\circ\text{C}$		0.5	0.4	
Continuous Drain Current ^b	$T_A=25^\circ\text{C}$	I_D	3.6	3.3	A
	$T_A=70^\circ\text{C}$		2.8	2.6	
Maximum Power Dissipation ^b	$T_A=25^\circ\text{C}$	P_D	0.7	0.6	W
	$T_A=70^\circ\text{C}$		0.4	0.3	
Pulsed Drain Current ^c		I_{DM}	15		A
Operating Junction Temperature		T_J	150		$^\circ\text{C}$
Lead Temperature		T_L	260		$^\circ\text{C}$
Storage Temperature Range		T_{stg}	-55 to 150		$^\circ\text{C}$

Thermal resistance ratings

Parameter		Symbol	Typical	Maximum	Unit
Junction-to-Ambient Thermal Resistance ^a	$t \leq 10 \text{ s}$	$R_{\theta JA}$	120	145	$^\circ\text{C/W}$
	Steady State		132	168	
Junction-to-Ambient Thermal Resistance ^b	$t \leq 10 \text{ s}$	$R_{\theta JA}$	145	174	
	Steady State		158	202	
Junction-to-Case Thermal Resistance		$R_{\theta JC}$	60	75	

a Surface mounted on FR4 Board using 1 square inch pad size, 1oz copper

b Surface mounted on FR4 board using minimum pad size, 1oz copper

c Repetitive rating, pulse width limited by junction temperature, $t_p=10\mu\text{s}$, Duty Cycle=1%

d Repetitive rating, pulse width limited by junction temperature $T_J=150^\circ\text{C}$.

Electronics Characteristics (Ta=25°C, unless otherwise noted)

Parameter	Symbol	Test Conditions	Min	Typ	Max	Unit
OFF CHARACTERISTICS						
Drain-to-Source Breakdown Voltage	BV_{DSS}	$V_{GS} = 0\text{ V}, I_D = 250\mu\text{A}$	20			V
Zero Gate Voltage Drain Current	I_{DSS}	$V_{DS} = 16\text{ V}, V_{GS} = 0\text{ V}$			1	μA
Gate-to-source Leakage Current	I_{GSS}	$V_{DS} = 0\text{ V}, V_{GS} = \pm 8\text{ V}$			± 100	nA
ON CHARACTERISTICS						
Gate Threshold Voltage	$V_{GS(TH)}$	$V_{GS} = V_{DS}, I_D = 250\mu\text{A}$	0.4	0.62	1.0	V
Drain-to-source On-resistance	$R_{DS(on)}$	$V_{GS} = 4.5\text{ V}, I_D = 3.6\text{ A}$		27	36	m Ω
		$V_{GS} = -2.5\text{ V}, I_D = 2.8\text{ A}$		31	41	
		$V_{GS} = 1.8\text{ V}, I_D = 2.0\text{ A}$		36	47	
Forward Transconductance	g_{FS}	$V_{DS} = 5\text{ V}, I_D = 3.6\text{ A}$		10		S
CHARGES, CAPACITANCES AND GATE RESISTANCE						
Input Capacitance	C_{ISS}	$V_{GS} = 0\text{ V}, f = 1.0\text{ MHz}, V_{DS} = 10\text{ V}$		1025		pF
Output Capacitance	C_{OSS}			125		
Reverse Transfer Capacitance	C_{RSS}			120		
Total Gate Charge	$Q_{G(TOT)}$	$V_{GS} = 4.5\text{ V}, V_{DS} = 10\text{ V}, I_D = 3.6\text{ A}$		12.0		nC
Threshold Gate Charge	$Q_{G(TH)}$			0.66		
Gate-to-Source Charge	Q_{GS}			1.0		
Gate-to-Drain Charge	Q_{GD}			3.3		
SWITCHING CHARACTERISTICS						
Turn-On Delay Time	$t_d(ON)$	$V_{GS} = 4.5\text{ V}, V_{DS} = 6\text{ V}, I_D = 2.0\text{ A}, R_G = 6\ \Omega$		6.5		ns
Rise Time	t_r			11.5		
Turn-Off Delay Time	$t_d(OFF)$			48		
Fall Time	t_f			20		
BODY DIODE CHARACTERISTICS						
Forward Voltage	V_{SD}	$V_{GS} = 0\text{ V}, I_S = 1.5\text{ A}$	0.5	0.6	1.5	V

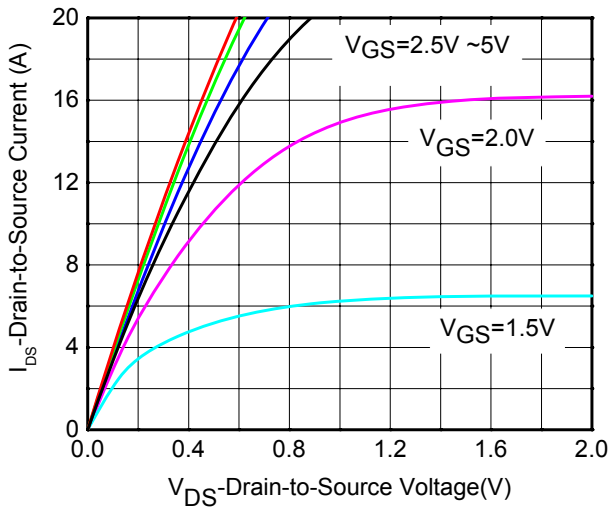
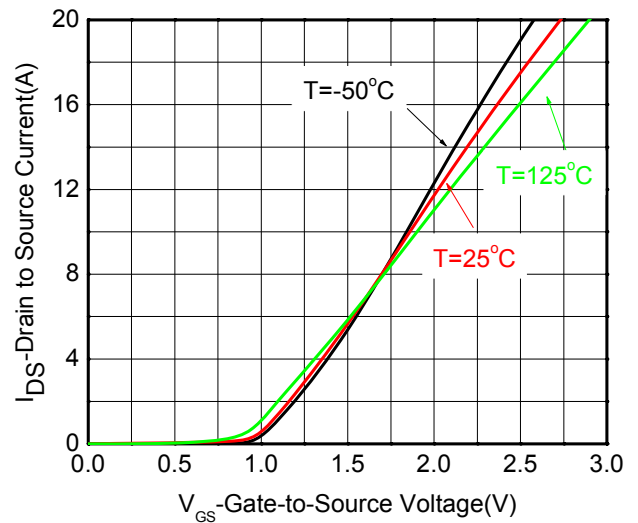
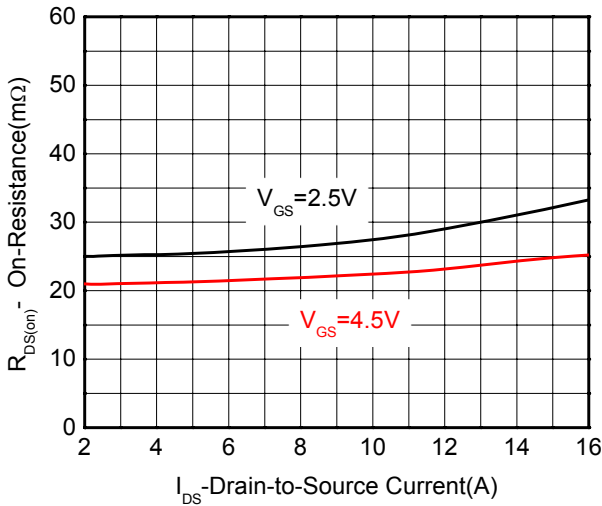
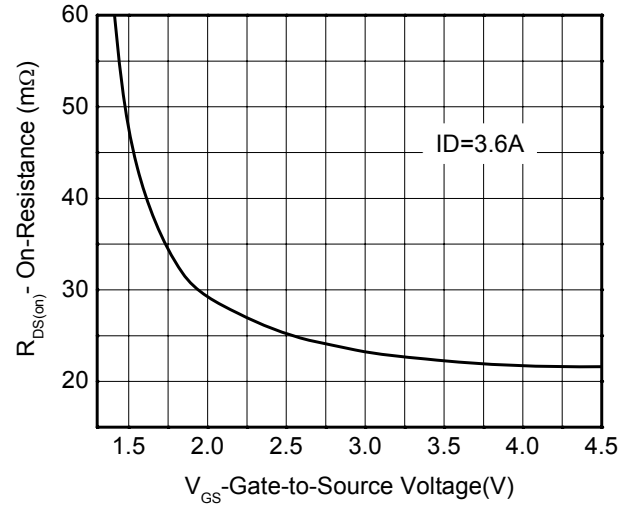
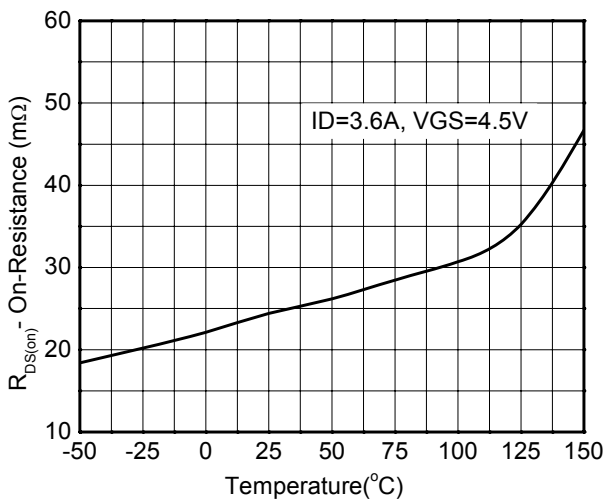
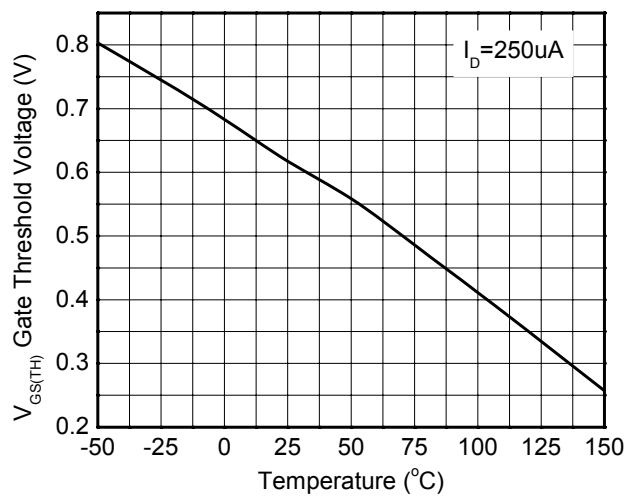
Typical Characteristics (Ta=25°C, unless otherwise noted)

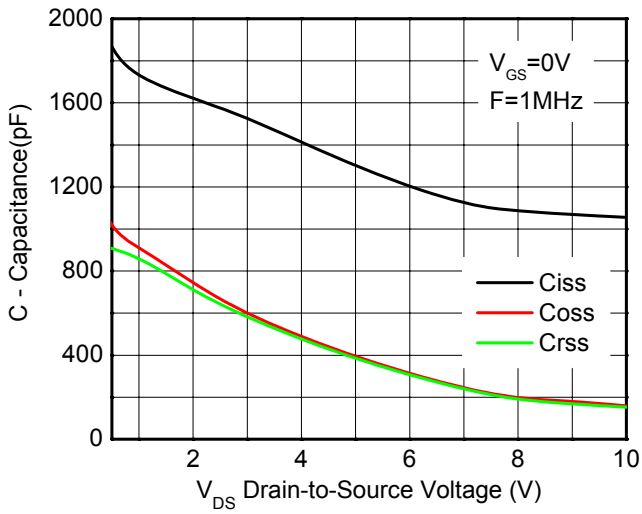
Output characteristics

Transfer characteristics

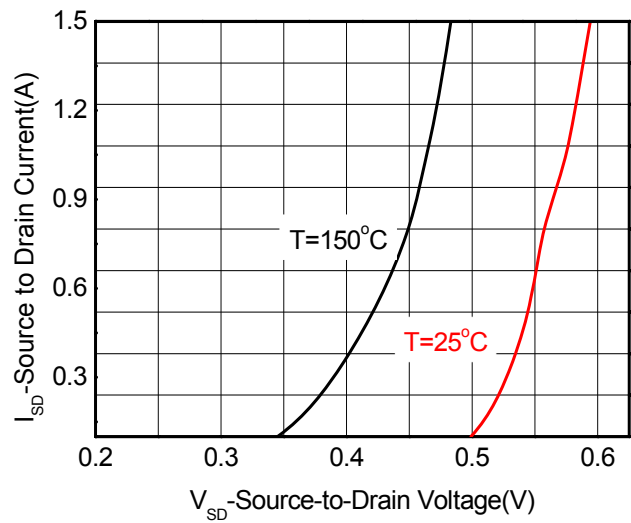
On-Resistance vs. Drain current

On-Resistance vs. Gate-to-Source voltage

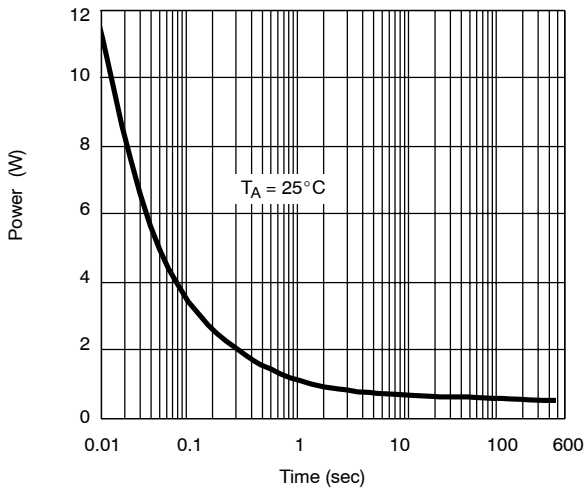
On-Resistance vs. Junction temperature

Threshold voltage vs. Temperature



Capacitance



Body diode forward voltage



Single pulse power

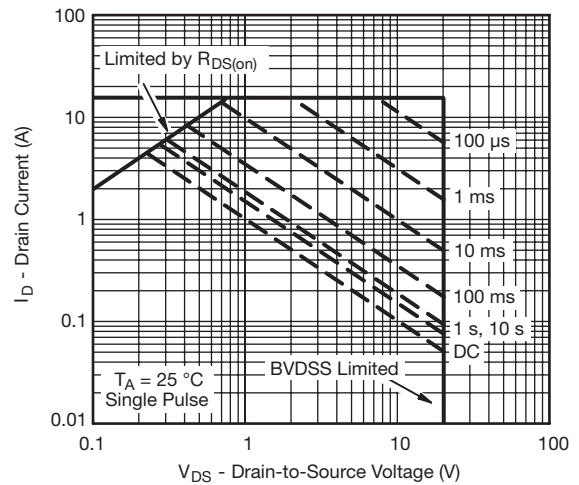

Safe operating area

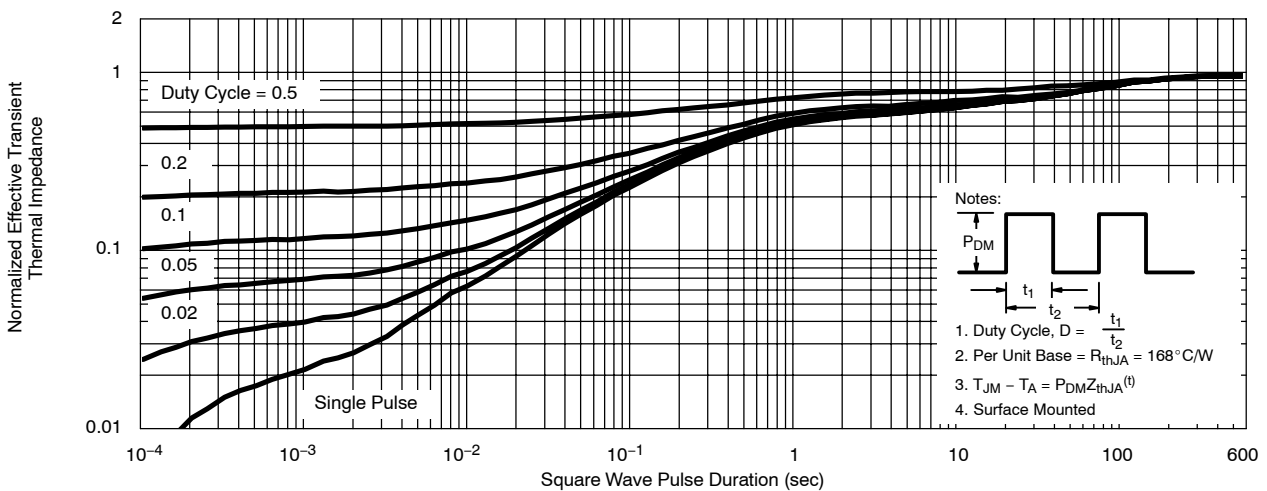

Transient thermal response (Junction-to-Ambient)

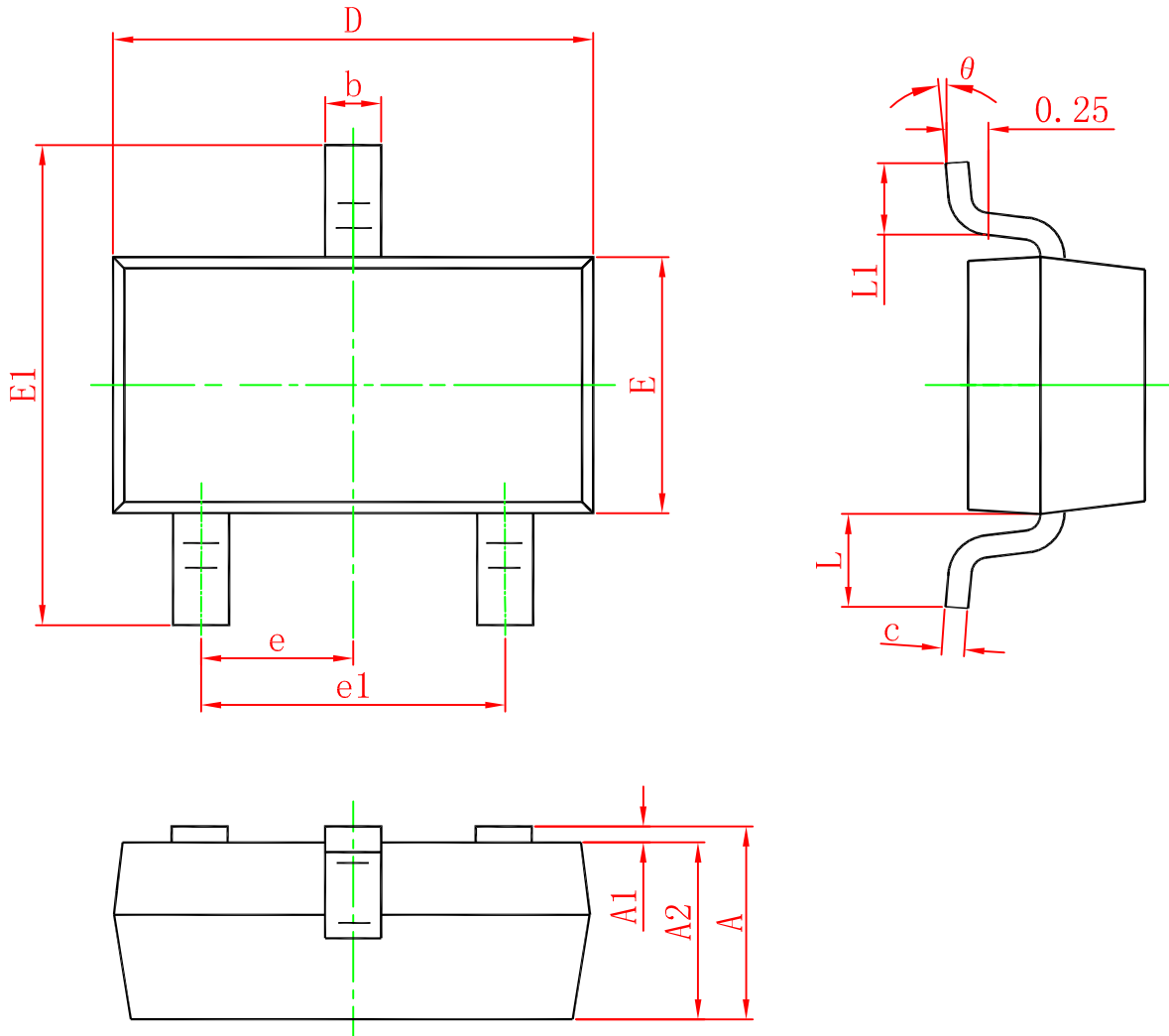
Package outline dimensions
SOT-23

Symbol	Dimensions in millimeter		
	Min.	Typ.	Max.
A	0.900	1.025	1.150
A1	0.000	0.050	0.100
A2	0.900	0.975	1.050
b	0.300	0.400	0.500
c	0.080	0.115	0.150
D	2.800	2.900	3.000
E	1.200	1.300	1.400
E1	2.250	2.400	2.550
e	0.950TYP		
e1	1.800	1.900	2.000
L	0.550REF		
L1	0.300		0.500
θ	0°		8°