

PLEASE CHECK WWW.MOLEX.COM FOR LATEST PART INFORMATION

Part Number: **0546987003**
Status: **Active**
Description: 0.80mm (.031") Pitch S.O. DIMM Socket, Right Angle, Surface Mount, 5.20mm (.205") Mounted Height, 144 Circuits, 3.3V Power Supply, Hard Tray Packaging, Height 11.00mm (.433") Type, Lead-free

Documents:

[3D Model](#) [Product Specification PS-54698-003 \(PDF\)](#)
[Drawing \(PDF\)](#) [RoHS Certificate of Compliance \(PDF\)](#)

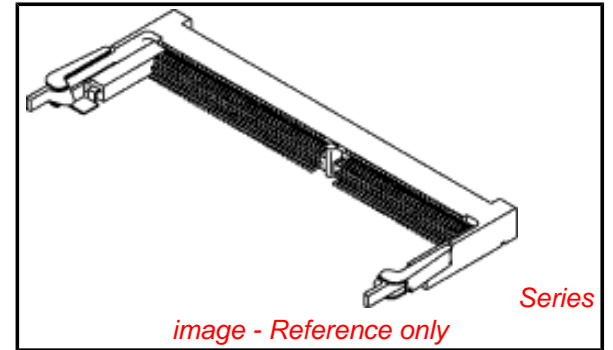

General

Product Family	Memory Module Sockets
Series	54698
Comments	3.3V Power Supply
Component Type	Memory Module
JEDEC Outline	N/A
Product Name	S.O. DIMM

Physical

Circuits (Loaded)	144
Color - Resin	Natural
Durability (mating cycles max)	30
Entry Angle	90° Angle (Side Entry)
Keying to Mating Part	Yes
Material - Metal	Brass, Phosphor Bronze
Material - Plating Mating	Gold
Material - Plating Termination	Tin
Material - Resin	High Temperature Thermoplastic
PCB Retention	Yes
PCB Thickness Recommended (in)	0.045 In
PCB Thickness Recommended (mm)	1.20 mm
Packaging Type	Tray
Pitch - Mating Interface (in)	0.031 In
Pitch - Mating Interface (mm)	0.80 mm
Plating min: Mating (µin)	10
Plating min: Mating (µm)	0.25
Plating min: Termination (µin)	40
Plating min: Termination (µm)	1
Temperature Range - Operating	-55°C to +85°C
Termination Interface: Style	Surface Mount

Electrical

Current - Maximum per Contact	0.3A
Voltage - Maximum	100V
Voltage Key	3.3V

Material Info

Reference - Drawing Numbers

Product Specification	PS-54698-003
Sales Drawing	SD-54698-004, SD-54698-005

EU RoHS ELV and RoHS Compliant REACH SVHC Contains SVHC: No Halogen-Free Status Not Reviewed	China RoHS 
---	--

Need more information on product environmental compliance?

Email productcompliance@molex.com
 For a multiple part number RoHS Certificate of Compliance, [click here](#)

Please visit the [Contact Us](#) section for any non-product compliance questions.

Search Parts in this Series
54698Series

Mates With
JEDEC Standard DRAM and SDRAM modules

DWG. NO. SD-54698-004

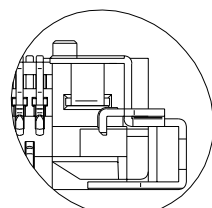
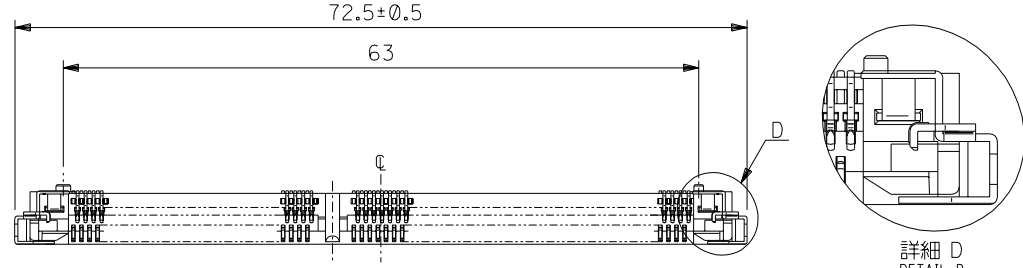

詳細 D
DETAIL D
(SCALE 5:1)

注記
NOTES

- 材料
MATERIAL
ハウジング : ガラス入り耐熱樹脂、白色、UL94V-0
ターミナル : 燐青銅
TERMINAL : PHOSPHOR BRONZE
ネイル : 黄銅
NAIL : BRASS
- めっき仕様
PLATING
ロングターミナル
LONG TERMINAL
接点部 : 金めっき 0.25μmMIN.
CONTACT AREA : GOLD 0.25 MICROMETER MINIMUM.
半田付け部 : 錫めっき 1.0μmMIN.
SOLDER TAIL AREA : TIN 1.0 MICROMETER MINIMUM.
下地めっき : ニッケルめっき 2.0μmMIN.
UNDER-PLATING : NICKEL 2.0 MICROMETER MINIMUM.
ショートターミナル
SHORT TERMINAL
接点部 : 金めっき 0.25μmMIN.
CONTACT AREA : GOLD 0.25 MICROMETER MINIMUM.
半田付け部 : 錫めっき 1.0μmMIN.
SOLDER TAIL AREA : TIN 1.0 MICROMETER MINIMUM.
下地めっき : ニッケルめっき 2.0μmMIN.
UNDER-PLATING : NICKEL 2.0 MICROMETER MINIMUM.
ネイル
NAIL
錫めっき : 1.0μmMIN.
TIN : 1.0 MICROMETER MINIMUM.
下地めっき : ニッケルめっき 1.0μmMIN.
UNDER-PLATING : NICKEL 1.0 MICROMETER MINIMUM.
- テール平坦度は、0.1 MAX.とする。
TAIL COPLANARITY TO BE 0.1 MAX.
ネイル平坦度は、0.1 MAX.とする。
NAIL COPLANARITY TO BE 0.1 MAX.
- 本製品は54698-144*の鉛フリー品である。
THIS PRODUCT IS LEAD FREE OF 54698-144*.

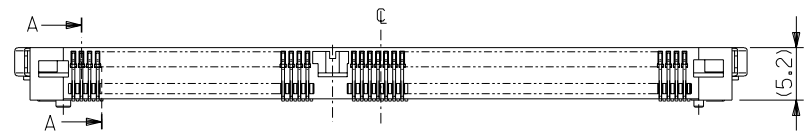
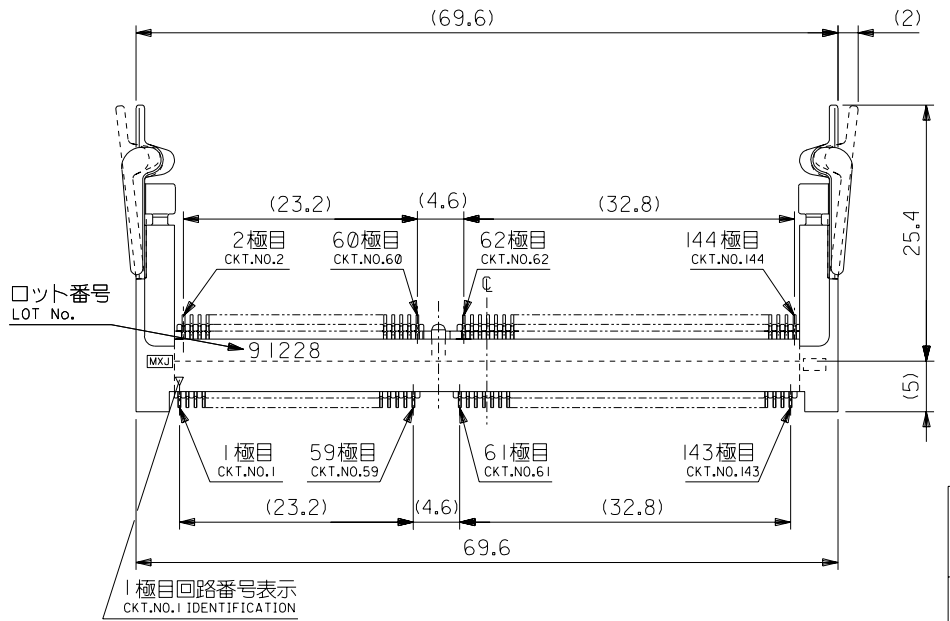

1.75	2.85	1.35	3.25	4.05	***V	ハードトレイ (高さ9)	54698-7008	54698-700*
						ハードトレイ (高さ11)	54698-7005	
						標準トレイ	54698-7002	
3.25	1.35	2.85	1.75	5.55	5.0V	ハードトレイ (高さ9)	54698-7007	
						ハードトレイ (高さ11)	54698-7004	
						標準トレイ	54698-7001	
2.5	2.1	2.1	2.5	4.8	3.3V	ハードトレイ (高さ9)	54698-7006	
						ハードトレイ (高さ11)	54698-7003	
						標準トレイ	54698-7000	
E	D	C	B	A	POWER SUPPLY	梱包トレイ	MATERIAL NO.	

DO NOT SCALE DRAWING

EC NO. DRWN: CHK: APPR:	EC NO. DRWN: CHK: APPR:	EC NO. DRWN: CHK: APPR:	EC NO. DRWN: CHK: APPR:	EC NO. DRWN: CHK: APPR:	<p>RELEASED EC NO. J2004-4231 04/05/14</p> <p>DRWN: M.NAGATA 04/05/14</p> <p>CHK: K.TOJO 04/05/14</p> <p>APPR: M.SASAO 04/05/14</p>	<p>MATERIAL 材料</p> <p>注記参照 SEE NOTES</p> <p>FINISH 仕上げ</p> <p>注記参照 SEE NOTES</p> <p>WIRE RANGE 適用電線範囲</p> <p>INS. RANGE 被覆外径</p>	<p>GENERAL TOLERANCES: (UNLESS SPECIFIED) 一般公差</p> <p>10 UNDER 未満 ±0.2</p> <p>10 OVER 30 UNDER 未満 ±0.25</p> <p>30 OVER 以上 ±0.3</p> <p>ANGLE 角度 ±3°</p>	<p>SCALE 2:1</p> <p>DESIGN UNITS <input checked="" type="checkbox"/>mm <input type="checkbox"/>INCH</p> <p>THIRD ANGLE PROJECTION</p> <p>TITLE: 0.8mm PITCH S.O.DIMM SOCKET 144CKT. HEIGHT 5.2mm -LEAD FREE-</p> <p>MOLEX MOLEX INCORPORATED</p>	<p>SH T REV</p> <p>REVISE ON CAD ONLY</p> <p>CAD FILENAME SD-54698-004.S01</p> <p>MATERIAL NO. SEE CHART</p> <p>DRAWING NO. SD-54698-004</p> <p>SHEET NO. 1 OF 3</p>	<p>THIS DRAWING CONTAINS INFORMATION THAT IS PROPRIETARY TO MOLEX INCORPORATED AND SHOULD NOT BE USED WITHOUT WRITTEN PERMISSION.</p> <p>SIZE B</p>
----------------------------------	----------------------------------	----------------------------------	----------------------------------	----------------------------------	---	--	--	--	--	---

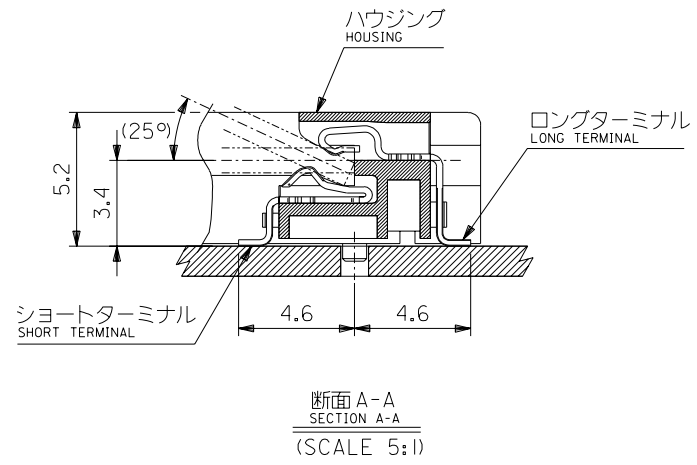
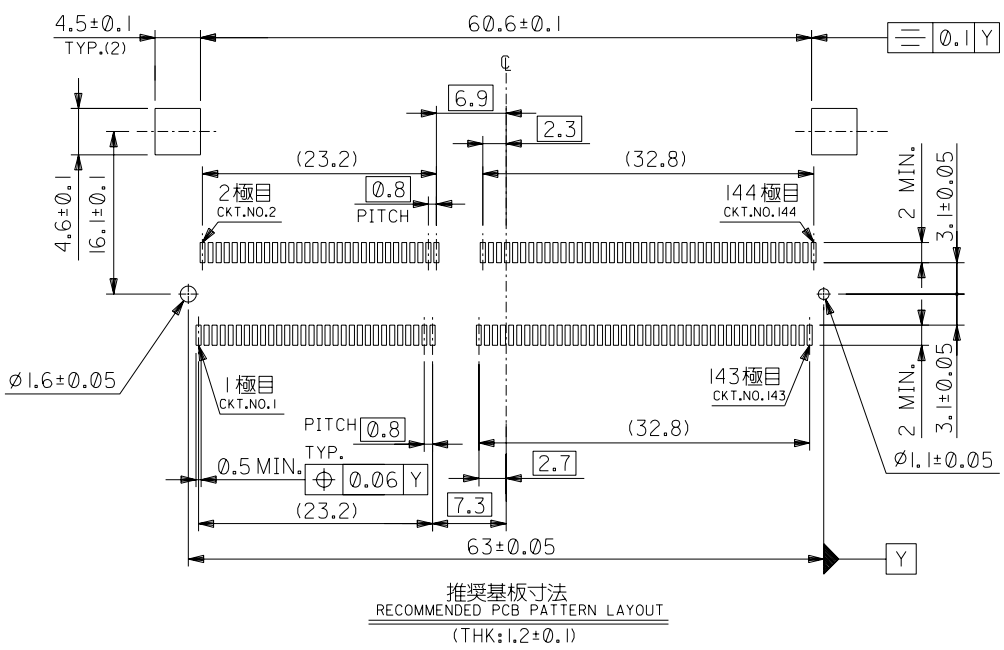

EC NO. DRWN: CHK: APPR:	EC NO. DRWN: CHK: APPR:	EC NO. DRWN: CHK: APPR:	EC NO. DRWN: CHK: APPR:	EC NO. DRWN: CHK: APPR:	EC NO. DRWN: CHK: APPR:
					0

DESCRIPTION	MATERIAL 材料	FINISH 仕上げ	WIRE RANGE 適用線径範囲	INS. RANGE 被覆外径
SEE 1 OF 3	注記参照 SEE NOTES	注記参照 SEE NOTES	—	—

GENERAL TOLERANCES: (UNLESS SPECIFIED) 一般公差	SCALE 2:1	DESIGN UNITS <input checked="" type="checkbox"/> mm <input type="checkbox"/> INCH	THIRD ANGLE PROJECTION	DIMENSIONS: <input type="checkbox"/> mm <input type="checkbox"/> INCH <input checked="" type="checkbox"/> mm ONLY	SHT REVISE ON CAD ONLY
10 UNDER 未満	±0.2	DRAWN BY & DATE M.NAGATA '04/05/14	TITLE: 0.8mm PITCH S.O.DIMM SOCKET 144CKT. HEIGHT 5.2mm -LEAD FREE-	MATERIAL NO. SD-54698-004	
10 OVER 30 UNDER 以上 未満	±0.25	CHECKED BY & DATE K.TOJO '04/05/14	MATERIAL NO. SD-54698-004		
30 OVER 以上	±0.3	APPROVED BY & DATE M.SASAO '04/05/14	DRAWING NO. SD-54698-004		
ANGLE 角度	±3°	CAD FILENAME SD-54698-004.S02	SHEET NO. 2 OF 3		

MODEL NO. 54698-700*	DIMENSIONS: <input type="checkbox"/> mm <input type="checkbox"/> INCH <input checked="" type="checkbox"/> mm ONLY	SHT REVISE ON CAD ONLY
THIS DRAWING CONTAINS INFORMATION THAT IS PROPRIETARY TO MOLEX INCORPORATED AND SHOULD NOT BE USED WITHOUT WRITTEN PERMISSION.		

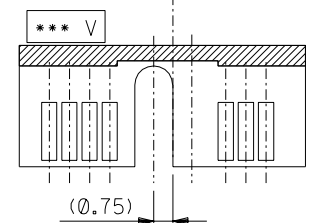
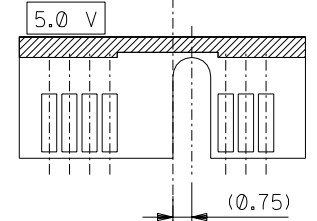
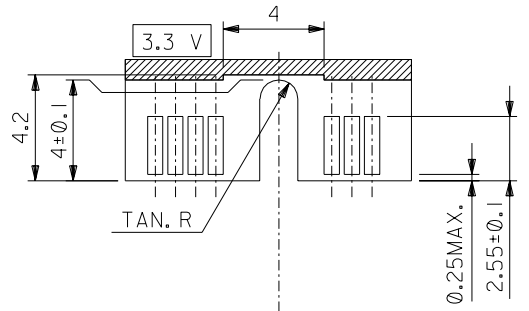
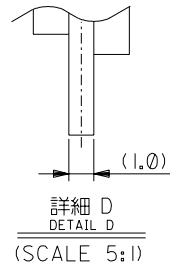
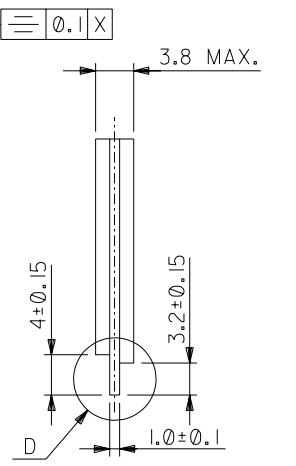
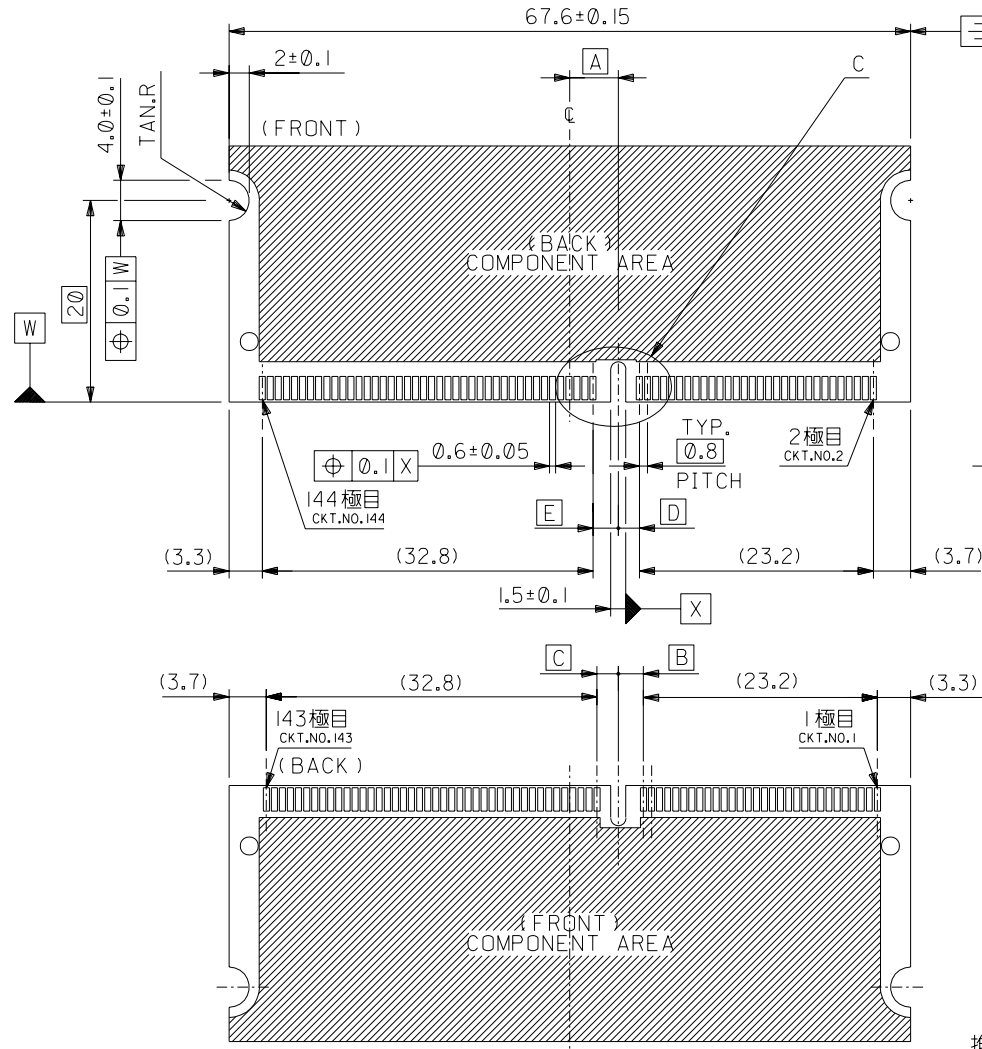

推奨基板寸法
RECOMMENDED MATING BOARD CONFIGURATION
(THK:1.0±0.1)

DO NOT SCALE DRAWING

EC NO. DRWN: CHK: APPR:	EC NO. DRWN: CHK: APPR:	EC NO. DRWN: CHK: APPR:	EC NO. DRWN: CHK: APPR:	EC NO. DRWN: CHK: APPR:	EC NO. DRWN: CHK: APPR:
SEE 1 OF 3					
DESCRIPTION					
MATERIAL 材料					
FINISH 仕上り					
WIRE RANGE 適用電線範囲					
INS. RANGE 被覆外径					

GENERAL TOLERANCES: (UNLESS SPECIFIED) 一般公差	10 UNDER 未満	±0.2
	10 OVER 以上 30 UNDER 未満	±0.25
	30 OVER 以上	±0.3
ANGLE 角度		±3°

SCALE 2:1	DESIGN UNITS mm INCH
DRAWN BY & DATE M.NAGATA '04/05/14	CHECKED BY & DATE K.TOJO '04/05/14
APPROVED BY & DATE M.SASAO '04/05/14	
CAD FILENAME SD-54698-004.S03	

MODEL NO. 54698-700*	DIMENSIONS: mm INCH mm INCH	SHT 3	REV
THIRD ANGLE PROJECTION	mm ONLY	REVISE ON CAD ONLY	
TITLE: 0.8mm PITCH S.O.DIMM SOCKET 144CKT. HEIGHT 5.2mm -LEAD FREE-			
MOLEX INCORPORATED			
MATERIAL NO. SEE CHART	DRAWING NO. SD-54698-004	SHEET NO. 3 OF 3	SIZE B
THIS DRAWING CONTAINS INFORMATION THAT IS PROPRIETARY TO MOLEX INCORPORATED AND SHOULD NOT BE USED WITHOUT WRITTEN PERMISSION.			

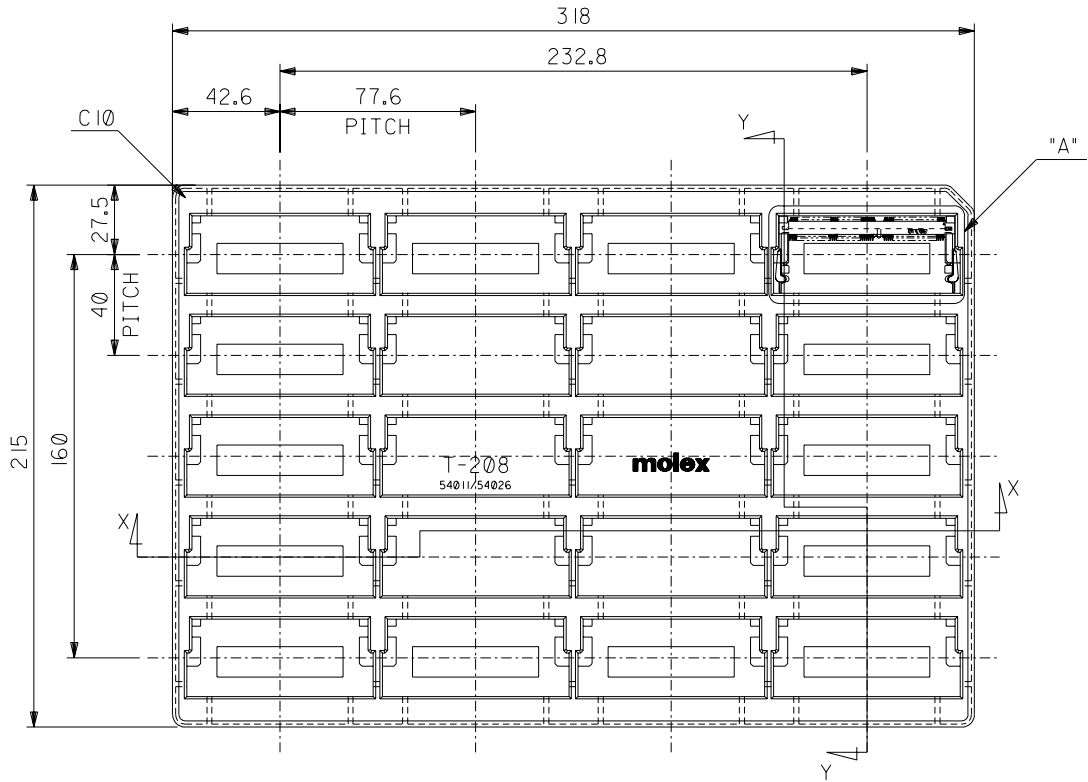

注記

1. 一般公差: ±0.5
GENERAL TOLERANCES: ±0.5
2. 各部の反りは2MAX.
WARP: 2MAX.
3. 1トレイの梱包数: 20個
QUANTITY IN ONE TRAY: 20PCS.
4. 標準梱包数: 300個
STANDARD PACKAGING QUANTITY: 300PCS.
5. 鉛フリー製品: 54698-700*の梱包図面である。
PACKING DRAWING OF 54698-700*(LEAD FREE).

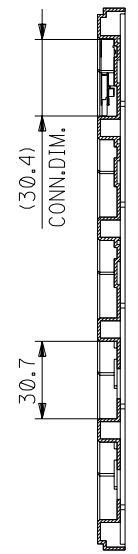

SECT. Y-Y

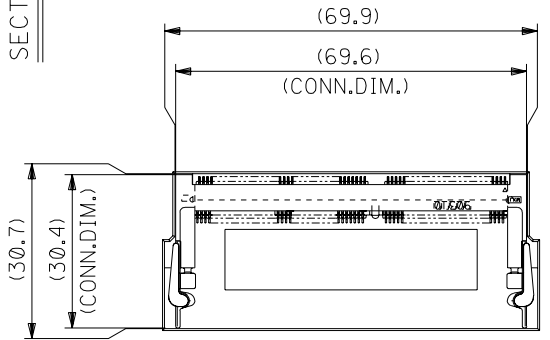

DETAIL A
(SCALE 1:1)

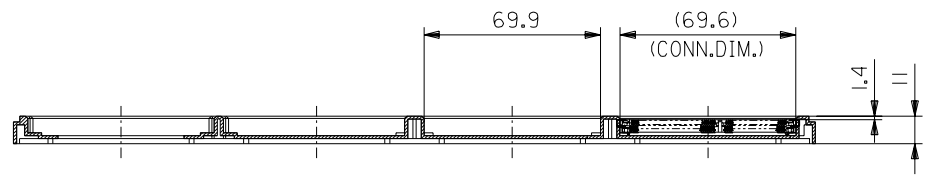

SECT. X-X

54698-7005	
54698-7004	T-208
54698-7003	
適用製品番号 APPLICABLE PART NO.	MATERIAL NO.
DIMENSIONS:	SHT REV
<input type="checkbox"/> mm <input type="checkbox"/> INCH	<input checked="" type="checkbox"/> mm ONLY
<input type="checkbox"/> INCH	<input type="checkbox"/> CAD ONLY

DO NOT SCALE DRAWING

64 NO. DRWN: CH'K: APPR:	63 NO. DRWN: CH'K: APPR:	62 NO. DRWN: CH'K: APPR:	61 NO. DRWN: CH'K: APPR:	RELEASED 60 NO. J2004-4231 DRWN: M.NAGATA CH'K: K.TOJO APPR: M.SASAO	MATERIAL 材料 ポリスチレン POLYSTYRENE (帯電防止剤入り) (ANTI-STATIC)
				FINISH 仕上げ //	GENERAL TOLERANCES: (UNLESS SPECIFIED) 一般公差
				WIRE RANGE 適用電線範囲 //	SCALE 1:2 DESIGN UNITS <input checked="" type="checkbox"/> mm <input type="checkbox"/> INCH
				INS. RANGE 被覆外径 //	DRAWN BY & DATE M.NAGATA '04/05/14
				REV 0	CHECKED BY & DATE K.TOJO '04/05/14
					APPROVED BY & DATE M.SASAO '04/05/14
					CAD FILENAME SD-54698-005.S01
					TITLE: HARD TRAY FOR 0.8mm PITCH S.O.DIMM HS'G ASS'Y 144CKT. -LEAD FREE-
					MOLEX INCORPORATED
					MATERIAL NO. SEE CHART DRAWING NO. SD-54698-005 SHEET NO. 1 OF 1
					THIS DRAWING CONTAINS INFORMATION THAT IS PROPRIETARY TO MOLEX INCORPORATED AND SHOULD NOT BE USED WITHOUT WRITTEN PERMISSION.