

Easy Build-A-Switch:

Below is a complete listing of available options for BP SERIES SIDE ACTUATED DIP SWITCHES. Build-A-Switch allows you to mix and match options to create the switch you need—simply select desired option from each category. All available options are shown on pages E-7 and E-8. Dashes, hyphens or spaces in the part number are not significant, and are shown for clarity only. Complete HOW TO ORDER information is at the end of this section, page E-8.

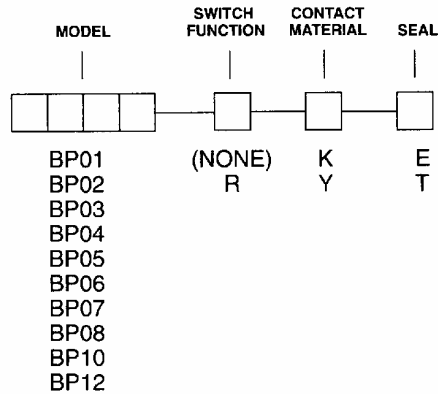

MODEL

MODEL NO.	NO. POS.	DIM. 'A'
BP01	1	.217 (5,50)
BP02	2	.315 (8,00)
BP03	3	.413 (10,50)
BP04	4	.512 (13,00)
BP05	5	.610 (15,50)
BP06	6	.709 (18,00)
BP07	7	.807 (20,50)
BP08	8	.906 (23,00)
BP10	10	1.102 (28,00)
BP12	12	1.299 (33,00)

Schematic:

SPST

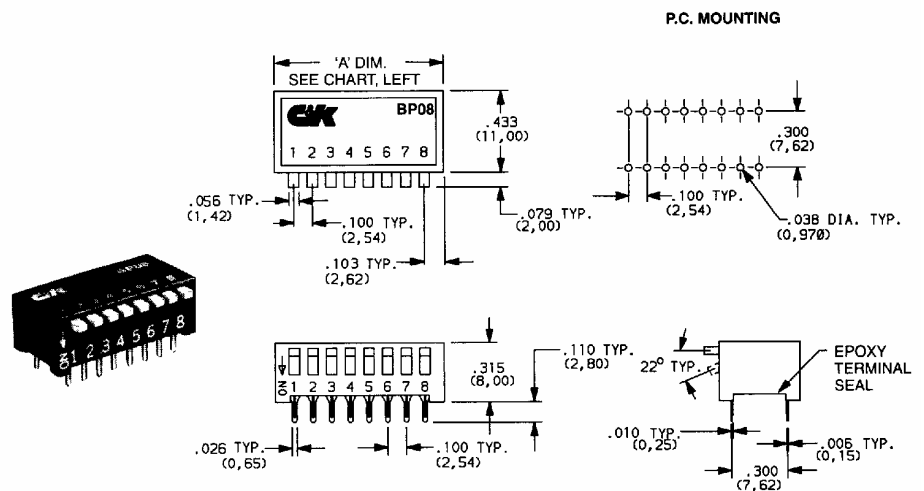

Part No. Shown: BP08KE

SWITCH FUNCTION

(NONE) (STD.) THROW

R REVERSE THROW

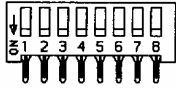

Actuator is DOWN in ON position, as shown.

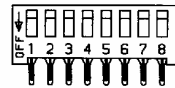

Actuator is UP in ON position, as shown.

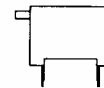

NOTE: All switches shipped in 'OFF' position standard.

CONTACT MATERIAL

OPTION CODE	CONTACT MATERIAL	TERMINAL PLATING	RATINGS	
K	GOLD ¹	TIN ²	LOW LEVEL / DRY CIRCUIT	CARRY: 100 mA max. @ 50 V DC; SWITCH: 100 mA max. @ 5 V DC or 25 mA max. @ 25 V DC.
Y	TIN ²	TIN ²		

¹ CONTACTS: Gold over nickel over phosphor bronze.

² CONTACTS & ALL TERMINALS: Phosphor bronze, tin plated.

SEAL

E (STD.) EPOXY TERMINAL SEAL, NO TAPE SEAL

T EPOXY TERMINAL SEAL, REMOVABLE TAPE ACTUATOR SEAL. SPLASH RESISTANT.

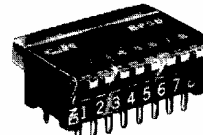
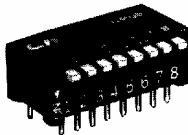

HOW TO ORDER

All available BP SERIES SIDE ACTUATED DIP SWITCH options are listed on page E-7, and are described on pages E-7 and E-8. When selecting options and building a part number, some ordering format boxes may not be filled. Dashes, hyphens or spaces in the part number are not significant and are shown for clarity only.

SPECIFICATIONS

SWITCH FUNCTION: SPST- 1, 2, 3, 4, 5, 6, 7, 8, 10, & 12 positions available.

CONTACT RATING:

Carry: 100 mA max. @ 50 V DC.

Switch: 100 mA max @ 5 V DC or 25 mA max. @ 25 V DC.

MECHANICAL & ELECTRICAL LIFE: 2,000 make-and-break cycles each circuit, models with gold contacts (K contact material). 1,000 cycles, models with tin contacts (Y contact material).

CONTACT RESISTANCE: Below 50 milliohms typ. initial @ 2-4 V DC, 100 mA.

INSULATION RESISTANCE: 10⁹ ohms min.

DIELECTRIC STRENGTH: 500 V RMS min. @ sea level between adjacent terminals.

STORAGE & OPERATING TEMPERATURE: -20°C to 60°C.

SOLDERABILITY: Per MIL-STD-202F method 208D, or EIA RS-186E method 9 (1 hour steam aging).

PACKAGING: Switches supplied in rigid dispensing tubes. Switch position 1 denotes pin no. 1. All switch actuators in 'OFF' position standard.

MATERIALS

CASE: Glass filled polyester (PET), flame retardant (UL 94V-0).

COVER: Anodized aluminum.

ACTUATOR: Glass filled polyester (PET), flame retardant, (UL 94V-0).

CONTACTS: Gold over nickel over phosphor bronze (K contact material) or phosphor bronze, tin plated (Y contact material).

TERMINALS: All terminals phosphor bronze, tin plated.

TERMINAL SEAL: Epoxy.

TAPE SEAL: Metalized polyester.

NOTE: Specifications and materials listed above are general specifications. Specifications available for specific and custom switches, consult factory.