



PRODUCT SPECIFICATION

Part Number PDM57300 Series

Details

- 3.0" (76.2mm) Dot Matrix Display
- 5x7 Array
- Available in Common Anode or Cathode
- Emitting Color: Pure Green, Yellow Green, Yellow, Amber, Orange-Red, Red or Deep Red

Features

- Low power consumption
- RoHS Compliant
- Gray or Black Face, White Segment
- Easy mounting on PCB or socket

Mechanical Dimensions

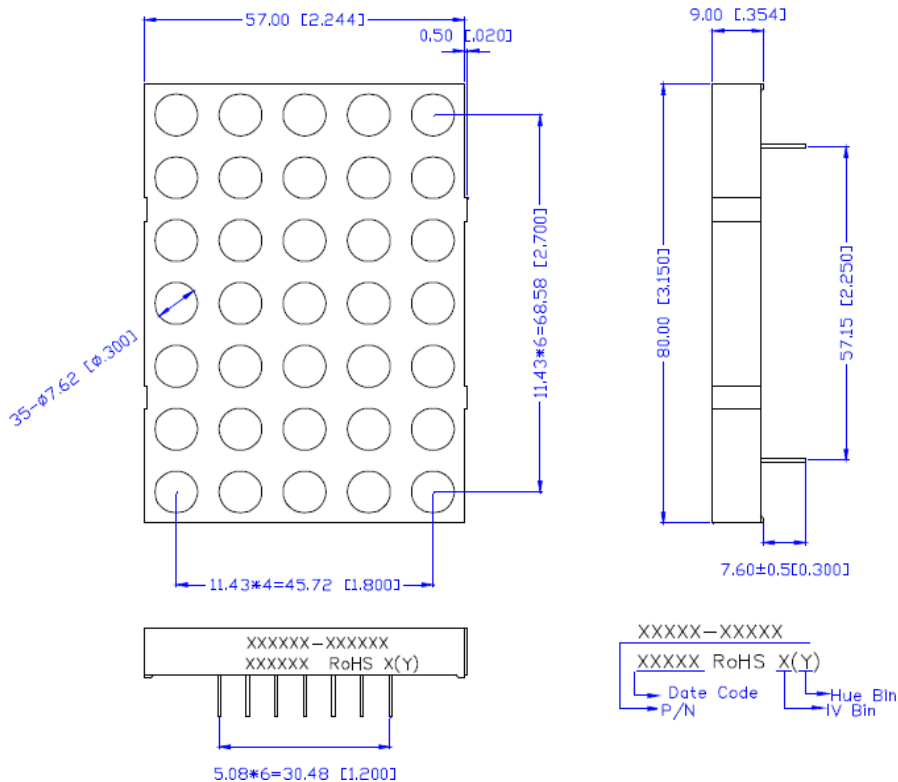

Notes:

1. Dimensions in millimeters [inch], and tolerance is ± 0.25 [0.010] and angle is $\pm 1^\circ$ unless otherwise noted.
2. Bending \leq Length*1%
3. All pins are $\phi 0.50$ [0.020] ± 0.1 [0.004]
4. Specifications subject to change without notice





Device Selection Guide

Model Number	Chip		Description
	Material	Emitting Color	
PDM57300x-G05	InGaN	True Green	Common Cathode x=C / Common Anode x=A
PDM57300x-G17	AlInGaP	Yellow Green	
PDM57300x-Y04		Yellow	
PDM57300x-A11		Amber	
PDM57300x-R02		Orange-Red	
PDM57300x-R11		Red	
PDM57300x-R21		Deep Red	

Absolute Maximum Ratings at Ta=25°C

Parameter	Symbol	Rating		Unit
		G17/Y04/A11/R02/R11/R21	G05	
Power Dissipation per Dice	PAD	70	114	mW
Derating Liner from 25°C per Dice	--	0.33	0.4	mA/°C
Continuous Forward Current Per Dice	IAF	25	30	mA
Peak Current Per Dice (duty cycle 1/10, 1KHz)	IPF	90	100	mA
Reverse Voltage Per Dice	VR	5	5	V
Electrostatic Discharge (HBM)	ESD	/	1000	V
Operating Temperature	Topr	-35~+85		°C
Storage Temperature	Tstg	-35~+85		°C

Solder Conditions: 1/16 inch below seating plane for 3 -5 seconds at 260°C.



Electrical and Optical Characteristics at Ta=25°C

Parameter	Symbol	Chip	Min.	Typ.	Max.	Unit	Condition
Forward Voltage Per Segment	VF	G05	--	6.4	7.6	V	IF=20mA
		G17/Y04/A11/R02/R11/R21	--	4	5.6		
Luminous Intensity Per Segment	Iv	G05	--	1100	--	mcd	IF=10mA
		G17	--	58	--		
		Y04	--	140	--		
		A11	--	220	--		
		R02	--	135	--		
		R11	--	128	--		
		R21	--	60	--		
Peak Emission Wavelength / Dominant Wavelength	$\lambda P/\lambda d$	G05	--	*525	--	nm	IF=20mA
		G17	--	572/570	--		
		Y04	--	592/590	--		
		A11	--	612/605	--		
		R02	--	632/625	--		
		R11	--	644/630	--		
		R21	--	660/645	--		
Reverse Current	IR		--	--	100	μ A	VR=5V
Luminous Intensity Matching Ratio	Iv-m		--	--	2:1	--	IF=10mA

Typical Electrical/Optical Characteristic Curves

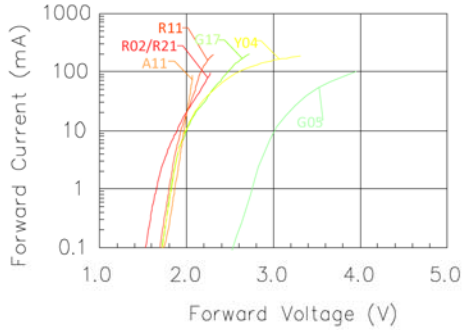

Fig 1. Forward Current vs. Forward Voltage

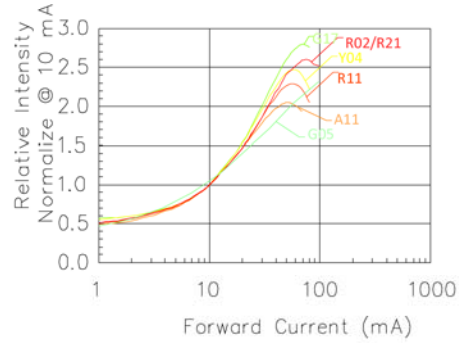

Fig 2. Relative Intensity vs. Forward Current

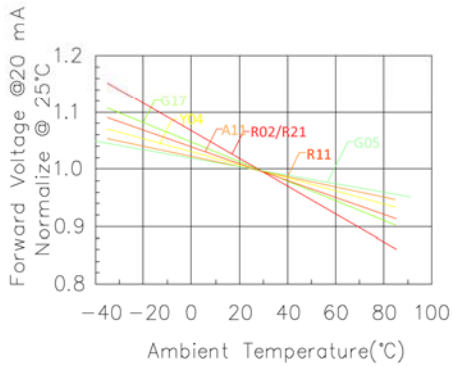

Fig 3. Forward Voltage vs. Temperature

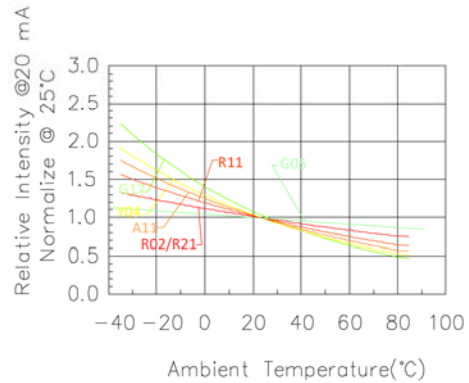

Fig 4. Relative Intensity vs. Temperature

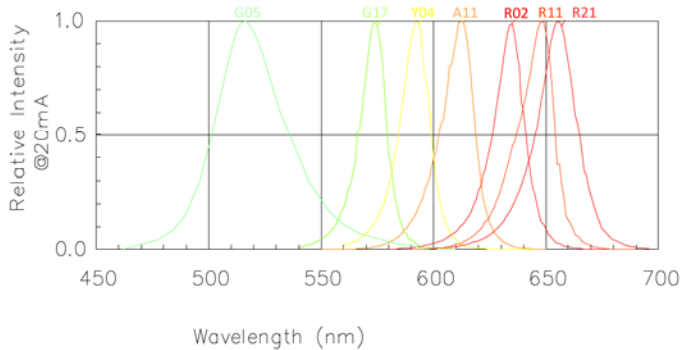

Fig 5. Relative Intensity vs. Wavelength

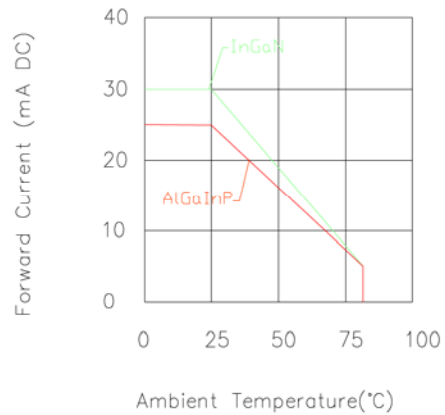

Fig 3. Forward Current vs. Ambient Temperature



Luminous General lv Bin Grade (IF = 10mA)

Color Rank Limits (IF=20mA)

Remark: Unit=mcd

*Tolerance: ±20%

Remark: Unit=nm

*Tolerance: ±1

● Pure Green(G05)

4	5	6	7	8
578.222	751.690	977.198	1270.359	1651.467
751.689	977.197	1270.358	1651.466	2146.907

1	2	3	4	5
515.0	518.0	520.0	522.0	524.0
518.0	520.0	522.0	524.0	527.0

● Yellow Green(G17)

R	S	T	U	V
32.261	41.940	54.523	70.881	92.146
41.939	54.522	70.880	92.145	119.790

0	1	2	3	4
567.5	569.5	570.5	571.5	573.0
569.4	570.4	571.4	572.9	575.0

● Yellow (Y04)

U	V	W	X	Y
70.881	92.146	119.791	155.730	202.450
92.145	119.790	155.729	202.449	263.184

1	2	3	4	5
583.0	585.0	587.0	589.0	591.0
585.0	587.0	589.0	591.0	593.0

● Amber (A11)

W	X	Y	1	2
119.791	155.730	202.450	263.185	342.142
155.729	202.449	263.184	342.141	444.785

● Orange (R02)

U	V	W	X	Y
70.881	92.146	119.791	155.730	202.450
92.145	119.790	155.729	202.449	263.184

● Red (R11)

U	V	W	X	Y
70.881	92.146	119.791	155.730	202.450
92.145	119.790	155.729	202.449	263.184

● Deep Red(R21)

R	S	T	U	V
32.261	41.940	54.523	70.881	92.146
41.939	54.522	70.880	92.145	119.790

All Light-On Segments Feature & Pad Position

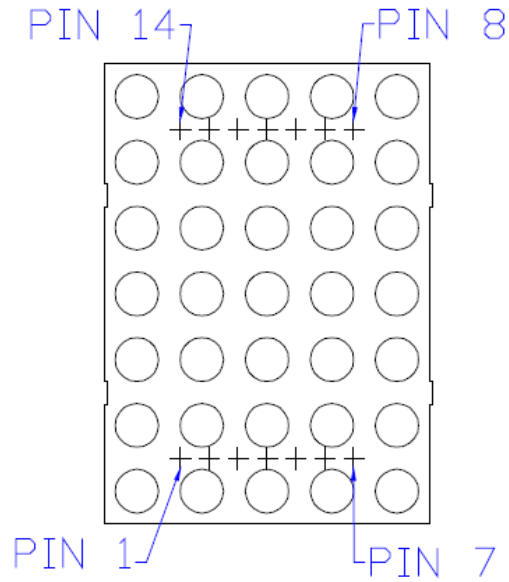

Internal Circuit Diagram

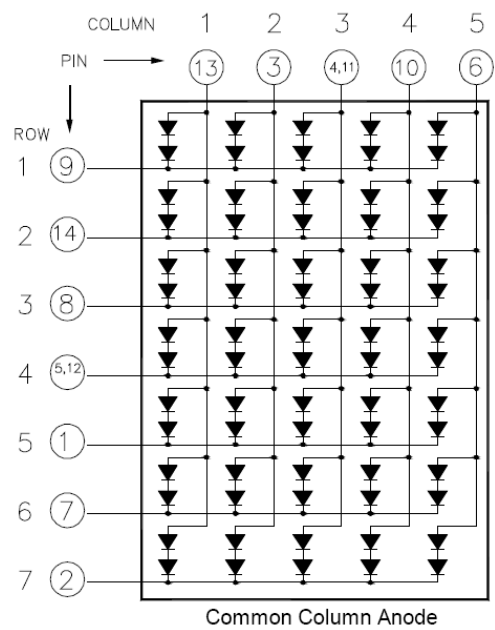
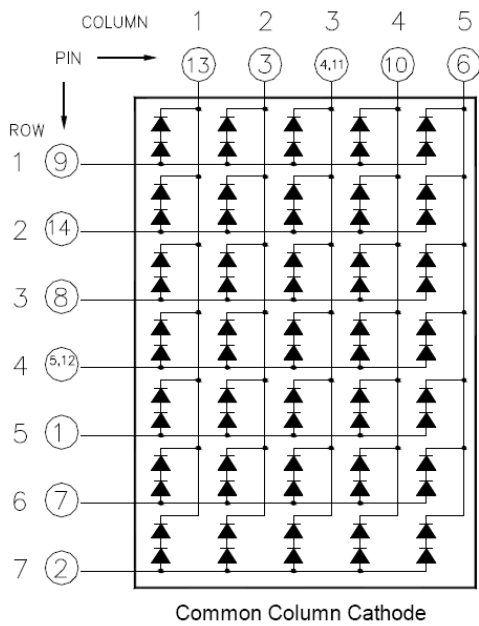

Precautions for Use

1. Recommended soldering conditions

1.1. Wave soldering

Basic SPEC is ≤ 5 sec. When 260°C . If temperature is higher, time should be shorter ($+10^{\circ}\text{C} \rightarrow -1$ sec.).

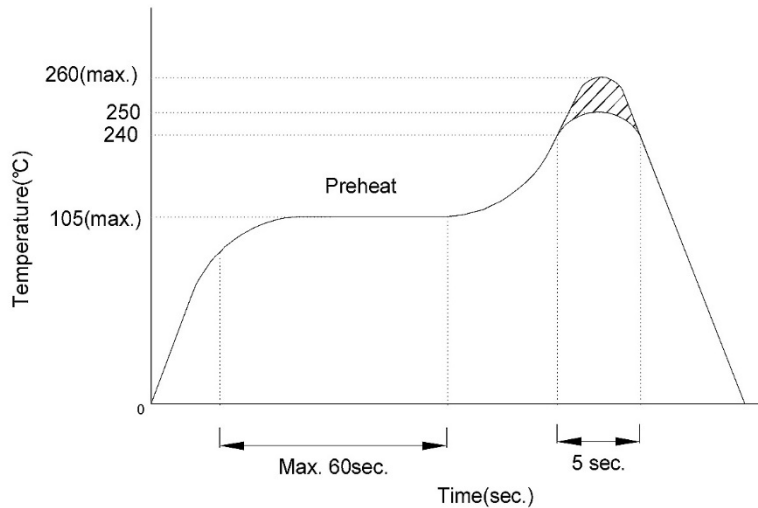

1.2. Soldering Iron:

Power dissipation of iron should be smaller than 15W and temp should be controllable. Soldering temperature should be under 260°C , time ≤ 3 sec.

Packing Dimensions

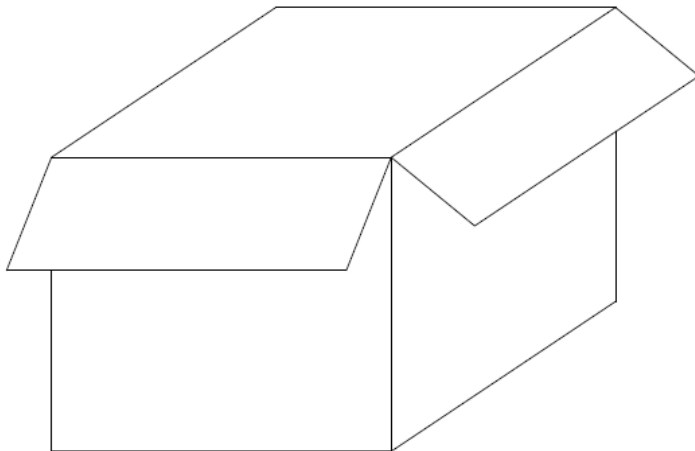
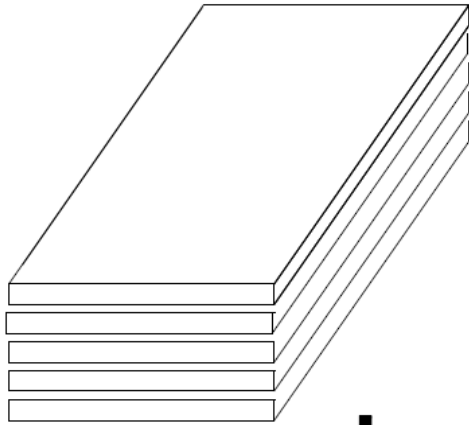
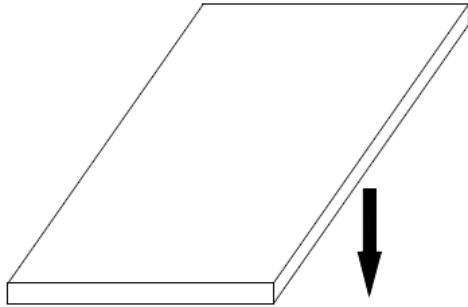

8 Pcs Per PE.foam
PE.foam Size:
L295xW195xH15mm

8 PE.foam Per Box
Q'TY: 64 PCS
Box Size:
L300*W205*H240mm