

1. PART NO. EXPRESSION :

SDC10031R5YZF-□□
 (a) (b) (c) (d)(e)(f) (g)

- (a) Series code
- (b) Dimension code
- (c) Inductance code : 1R5 = 1.5uH
- (d) Tolerance code : Y = ±30%
- (e) X, Y, Z : Standard part
- (f) F : RoHS Compliant
- (g) 11 ~ 99 : Internal controlled number

2. CONFIGURATION & DIMENSIONS :

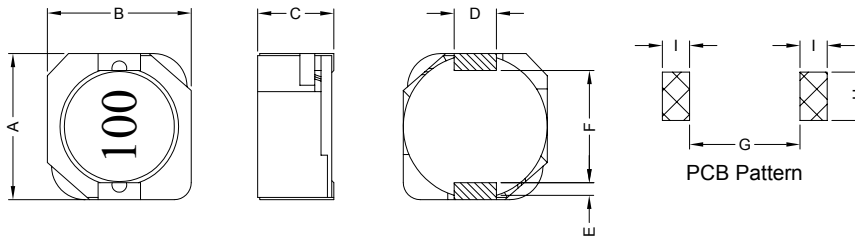

A	B	C	D	E	F	G	H	I
10.3±0.3	10.0±0.3	3.8±0.2	3.0±0.1	1.5±0.2	7.3±0.3	7.3 Ref.	3.2 Ref.	1.8 Ref.

3. SCHEMATIC :

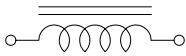

4. MATERIALS :

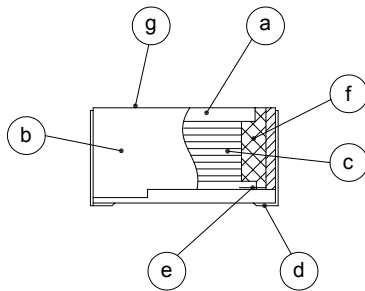

- (a) Core : DR Ferrite Core
- (b) Core : RI Ferrite Core
- (c) Wire : Enamelled Copper Wire
- (d) Lead : Au+Ni Copper Plate
- (e) Adhesive : Epoxy
- (f) Adhesive : Epoxy
- (g) Ink : Bon Margue

5. GENERAL SPECIFICATION :

- a) Rated current : $\Delta L/L0A=35\%$ Max.
- b) Storage temp. : -40°C to +125°C
- c) Operating temp. : -40°C to +85°C
- d) Resistance to solder heat : 260°C.10 secs



RoHS Compliant

NOTE : Specifications subject to change without notice. Please check our website for latest information.



6. ELECTRICAL CHARACTERISTICS :

Part No.	Inductance (μ H)	Test Freq. (Hz)	RDC (m Ω) Max.	IDC (A) Max.
SDC10031R5YZF-□□	1.50 \pm 30%	1V/100K	8.1	10.00
SDC10032R5YZF-□□	2.50 \pm 30%	1V/100K	10.0	7.50
SDC10033R8YZF-□□	3.80 \pm 30%	1V/100K	13.0	6.00
SDC10035R2YZF-□□	5.20 \pm 30%	1V/100K	22.0	5.50
SDC10037R0YZF-□□	7.00 \pm 30%	1V/100K	27.0	4.80
SDC1003100YZF-□□	10.00 \pm 30%	1V/100K	35.0	4.40
SDC1003150YZF-□□	15.00 \pm 30%	1V/100K	50.0	3.60
SDC1003220YZF-□□	22.00 \pm 30%	1V/100K	73.0	2.90
SDC1003330YZF-□□	33.00 \pm 30%	1V/100K	93.0	2.30
SDC1003470YZF-□□	47.00 \pm 30%	1V/100K	128.0	2.10
SDC1003680YZF-□□	68.00 \pm 30%	1V/100K	213.0	1.50
SDC1003820YZF-□□	82.00 \pm 30%	1V/100K	283.0	1.45
SDC1003101YZF-□□	100.00 \pm 30%	1V/100K	304.0	1.35
SDC1003151YZF-□□	150.00 \pm 30%	1V/100K	506.0	1.15
SDC1003221YZF-□□	220.00 \pm 30%	1V/100K	756.0	0.92
SDC1003331YZF-□□	330.00 \pm 30%	1V/100K	1090.0	0.70



RoHS Compliant

NOTE : Specifications subject to change without notice. Please check our website for latest information.

01.10.2010



SUPERWORLD ELECTRONICS (S) PTE LTD

7. CHARACTERISTICS CURVES :

@ TEMP. RISE VS. DC SUPERPOSITION RESPONSE CURVE

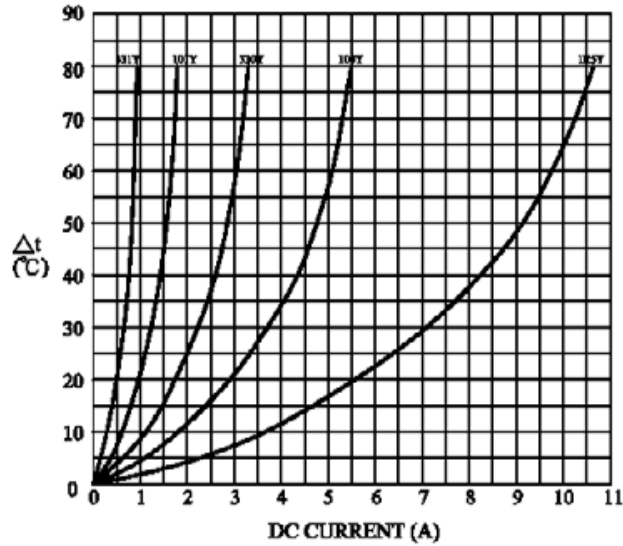

@ INDUCTANCE VS. FREQUENCY RESPONSE CURVE

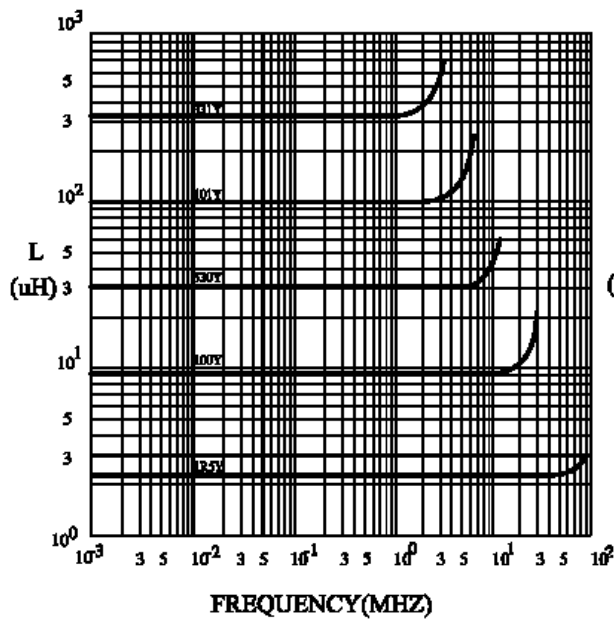

@ INDUCTANCE VS. DC SUPERPOSITION RESPONSE CURVE

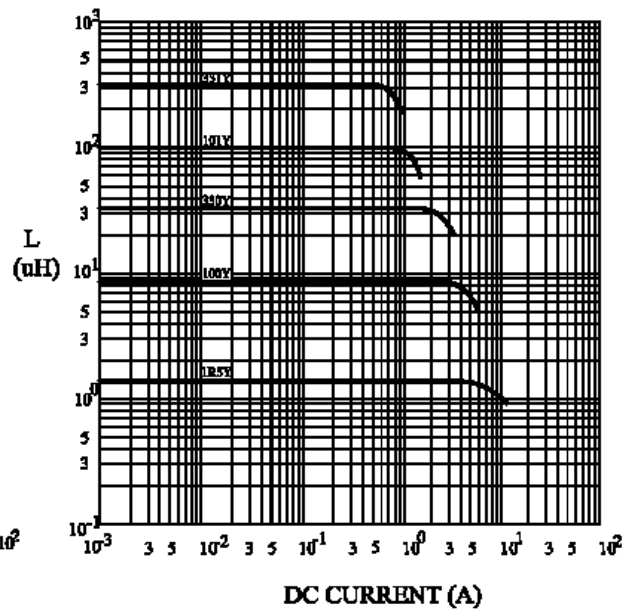

RoHS Compliant

NOTE : Specifications subject to change without notice. Please check our website for latest information.



RECOMMENDED SOLDERING CONDITIONS REFLOW SOLDERINGS

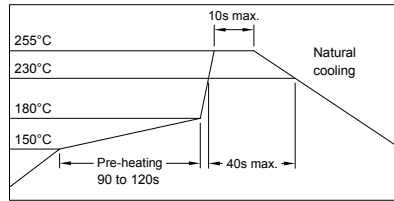

8. PACKAGING INFORMATION :

(1) CONFIGURATION

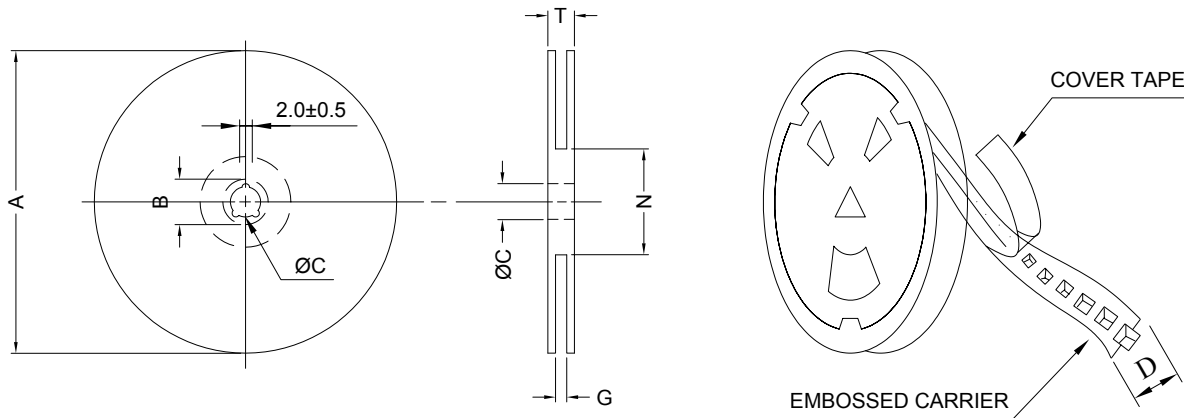

* CARRIER TAPE WIDTH : D

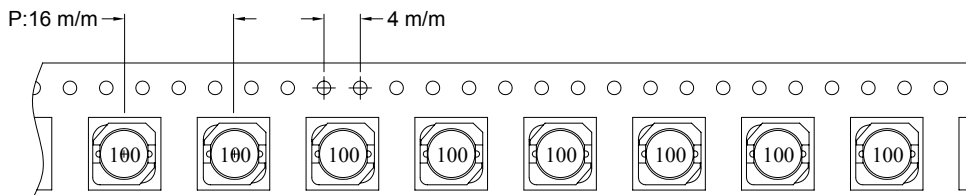

(2) DIMENSIONS

Unit:m/m

STYLE	A	B	C	D	G	N	T
13-24	330	21±0.8	13	24	26 ⁺⁰	50 ⁻⁰	30.4

(3) Q'TY & G.W. PER PACKAGE

SERIES	INNER : REEL			OUTER : CARTON		
	Q'TY (PCS)	G.W. (gw)	STYLE	Q'TY (PCS)	G.W. (Kg)	SIZE (cm)
SDC1003	600	900	13-24	2400	7.1	40 x 40 x 24



RoHS Compliant

NOTE : Specifications subject to change without notice. Please check our website for latest information.

01.10.2010



SUPERWORLD ELECTRONICS (S) PTE LTD

9. RELIABILITY AND TEST CONDITION :

TEST ITEM	SPECIFICATION	TEST CONDITION
SOLDERABILITY	MORE THAN 90% OF THE TERMINAL ELECTRODE SHALL BE COVERED WITH FRESH SOLDER.	PREHEAT : 125±25°C FOR 60 SECONDS SOLDER : 99%Sn/0.3%Ag/0.7%Cu OR EQUIVALENT SOLDER TEMP. : 245±5°C FLUX : ROSIN DIP TIME : 4±1 SECONDS
THERMAL SHOCK TEST (TEMP. CYCLE)	INDUCTANCE SHALL NOT CHANGE MORE THAN ±20%	ROOM TEMP. → -25±2°C 15 MINUTES → 30 MINUTES ROOM TEMP. → 85±2°C 15 MINUTES → 30 MINUTES TOTAL : 50 CYCLES
HUMIDITY RESISTANCE TEST		TEMPERATURE : 40±2°C HUMIDITY : 90 ~ 95% APPLIED CURRENT : PER SPEC. TIME : 500 HOURS
HIGH TEMP. RESISTANCE TEST		TEMPERATURE : 85±2°C APPLIED CURRENT : PER SPEC. TIME : 500 HOURS

10. UL CARD :

OBMW2		November 30, 2000		
Magnet Wire - Component				
PACIFIC ELECTRIC WIRE & CABLE (SHENZHEN) CO LTD				E201757
607 BAOLONG INDUSTRIAL ESTATE LONGGANG, SHENZHEN GUANGDONG CHINA				
	Coating Type		ANSI	
Mtl Dsg	BC	TC	Type	TI
UEW/U	Polyurethane	—	—	130
PEW/U	Polyester	—	MW5-C	155°C
PEWH/U	Modified Polyester	—	MW30-C	180
PEW-NY/U	Polyester	Polyamide	MW24-C	155
HAI/U	Polyester(Amide)(Imide)	Polyamideimide	MW35,73	200
UEW-NY/U	Polyurethane	Polyamide	MW80-C	155
			MW28-C	130
 Marking: Company name and material designation or marked designation on package or reel, and Recognized Component Mark.				
See General Information Preceding These Recognitions				
1/3/2001	Underwriters Laboratories Inc.		Card 1 of 2	



RoHS Compliant

NOTE : Specifications subject to change without notice. Please check our website for latest information.

