



UM18-217161102

UM18

ULTRASONIC SENSORS

**SICK**  
Sensor Intelligence.



### Ordering information

Type	Part no.
UM18-217161102	6048409

Other models and accessories → [www.sick.com/UM18](http://www.sick.com/UM18)



### Detailed technical data

#### Performance

<b>Working range, limiting range</b>	20 mm ... 150 mm, 250 mm
<b>Resolution</b>	0.2 mm
<b>Repeatability</b>	± 0.15 % <sup>1)</sup>
<b>Accuracy</b>	0.17 % / K <sup>1)</sup>
<b>Response time</b>	32 ms
<b>Switching frequency</b>	25 Hz
<b>Output time</b>	8 ms
<b>Ultrasonic frequency (typical)</b>	380 kHz
<b>Detection area (typical)</b>	See diagrams
<b>Additional function</b>	Set switching mode: Distance to object (DtO) / Window (Wnd) / Object between sensor and background (ObSB), teach-in of switching output, invertible switching output, reset to factory default

<sup>1)</sup> Referring to current measurement value.

#### Interfaces

<b>Switching output</b>	1 x PNP (200 mA) <sup>1)</sup>
<b>Hysteresis</b>	2 mm

<sup>1)</sup> PNP: HIGH =  $V_S - (< 2 V)$  / LOW = 0 V.

#### Mechanics/electronics

<b>Supply voltage <math>V_s</math></b>	DC 10 V ... 30 V <sup>1)</sup>
<b>Power consumption</b>	≤ 1.2 W <sup>2)</sup>
<b>Initialization time</b>	< 300 ms
<b>Design</b>	Cylindrical
<b>Housing material</b>	PBT Ultrasonic transducer: polyurethane foam, glass epoxy resin
<b>Connection type</b>	Male connector, M12, 4-pin
<b>Indication</b>	2 x LED

<sup>1)</sup> Limit values, reverse-polarity protected, operation in short-circuit protected network: max. 8 A.

<sup>2)</sup> Without load.

<b>Weight</b>	20 g
<b>Sending axis</b>	Angled

- 1) Limit values, reverse-polarity protected, operation in short-circuit protected network: max. 8 A.  
2) Without load.

### Ambient data

<b>Enclosure rating</b>	IP 67
<b>Protection class</b>	III
<b>Ambient temperature</b>	Operation: -25 °C ... +70 °C Storage: -40 °C ... +85 °C

### Dimensional drawing (Dimensions in mm (inch))

UM18-2xxxxx2

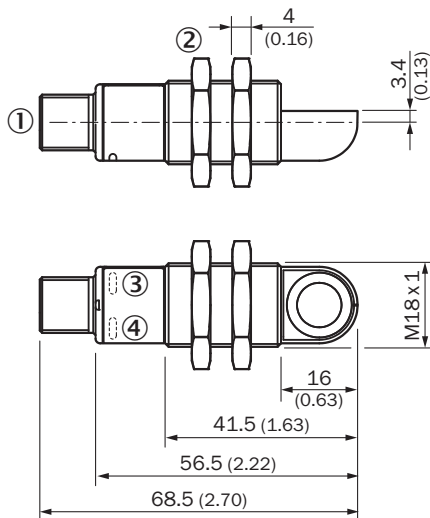

- ① Connection
- ② Mounting nuts, SW 24 mm
- ③ Status indicator operating voltage active (green)
- ④ Status indicator switching/analog output (orange)

### Connection type

UM1x-x17 connector M12, 5-pin



Male connector M12, 5-pin



Connection diagram

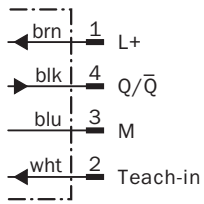

Detection area

UM1x-x17

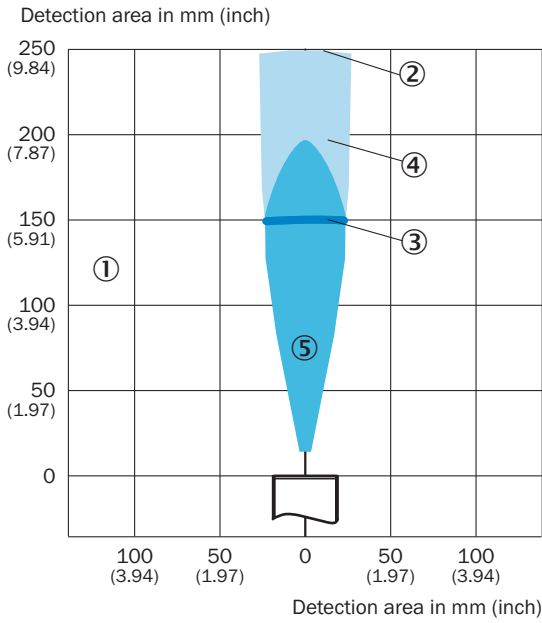







- ① Sensing range dependent on reflection properties, size and orientation of the object
- ② Limiting range
- ③ Working range
- ④ Example object: aligned plate 500 mm x 500 mm
- ⑤ Example object: pipe with 10 mm diameter

Recommended accessories

Other models and accessories → [www.sick.com/UM18](http://www.sick.com/UM18)

	Brief description	Type	Part no.
Universal bar clamp systems			
	Plate H for universal clamp bracket, steel, zinc coated, universal clamp and mounting hardware included	BEF-KHS-H01	2022465
Mounting brackets and mounting plates			

	Brief description	Type	Part no.
	Mounting plate for M18 sensors, steel, zinc coated, without mounting hardware	BEF-WG-M18	5321870
	Mounting bracket, M18 thread, steel, zinc coated, without mounting hardware	BEF-WN-M18	5308446
<b>Terminal and alignment brackets</b>			
	Mounting bracket with ball-and-socket, plastic, mounting hardware included	BEF-WN-M18-ST02	5312973
	Clamping block for round sensors M18, with fixed stop, plastic (PA12), glass-fiber reinforced, mounting hardware included	BEF-KHF-M18	2051482
<b>Plug connectors and cables</b>			
	Head A: female connector, M12, 4-pin, straight Head B: cable Cable: PVC, unshielded, 2 m	DOL-1204-G02M	6009382
	Head A: female connector, M12, 4-pin, angled Head B: cable Cable: PVC, unshielded, 2 m	DOL-1204-W02M	6009383

## SICK AT A GLANCE

SICK is one of the leading manufacturers of intelligent sensors and sensor solutions for industrial applications. A unique range of products and services creates the perfect basis for controlling processes securely and efficiently, protecting individuals from accidents and preventing damage to the environment.

We have extensive experience in a wide range of industries and understand their processes and requirements. With intelligent sensors, we can deliver exactly what our customers need. In application centers in Europe, Asia and North America, system solutions are tested and optimized in accordance with customer specifications. All this makes us a reliable supplier and development partner.

Comprehensive services complete our offering: SICK LifeTime Services provide support throughout the machine life cycle and ensure safety and productivity.

For us, that is “Sensor Intelligence.”

## WORLDWIDE PRESENCE:

Contacts and other locations –[www.sick.com](http://www.sick.com)