

TVS/ESD Arrays

RLSD92QxxxV Series

TVS/ESD Arrays - RLSD92QxxxV Series

Features

- 40W Power Dissipation (8/20 μ s Waveform)
- Low Leakage Current, Maximum of 2.5 μ A@3.3Vdc
- Very low Clamping voltage
- IEC 61000-4-2 ESD 30kV air, 30kV Contact Compliance
- Lead free in comply with EU RoHS 2011/65/EU directives.
- Green molding compound as per IEC61249 Std. . (Halogen Free)
- Terminals : Solderable per MIL-STD-750, Method 2026
- Case : DFN 2L, Plastic

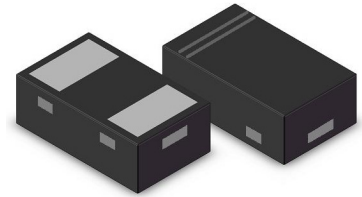

Mechanical Characteristics

- DFN-2L package
- Molding compound flammability rating: UL 94V-0
- Packaging: Tape and Reel per EIA 481
- Lead Finish: Matte tin
- RoHS Compliant

Applications

- Video I/O ports protection
- Set Top Boxes
- Portable Instrumentation
- Notebooks, Desktops, and Servers
- Pagers Peripherals

Life Support Note

- Not Intended for Use in Life Support or Life Saving Applications
- The products shown herein are not designed for use in life sustaining or life saving applications unless otherwise expressly indicated

Pinout and Functional Block Diagram

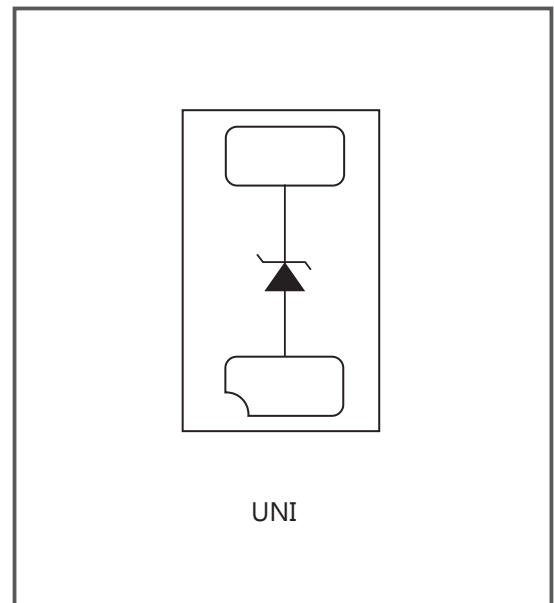

TVS/ESD Arrays - RLSD92QxxxV Series

Absolute Maximum Rating

Rating	Symbol	Value	Units
Peak Pulse Power (8/20 μ s Waveform)	P _{pp}	40	Watts
Peak Pulse Current (8/20 μ s Waveform)	I _{PPM}	6	A
Operating Junction and Storage Temperature Range	T _J , T _S T _G	-55 to +150	°C

Electrical Characteristics Per Lin (@ 25°C Unless Otherwise Specified)

Type Number	Peak Power Dissipation @8/20 μ S P _{ppm}	Reverse Stand-Off Voltage	Peak Pulse Voltage @8/20 μ S P _{ppm}	Peak Pulse Current @8/20 μ S P _{ppm}	Reverse Leakage @V _{rw}	Maximum Capacitance @1MHZ
		V _{rw}	V _{c@IPP}	I _{PP}	I _{R@V_{rw}}	Co
		Max			Max	Max
UNI	W	V	V	A	μ A	UNI(pF)
RLSD92Q051V	40	5	9.8	4	1	35

TVS/ESD Arrays - RLSD92QxxxV Series

Typical Characteristics

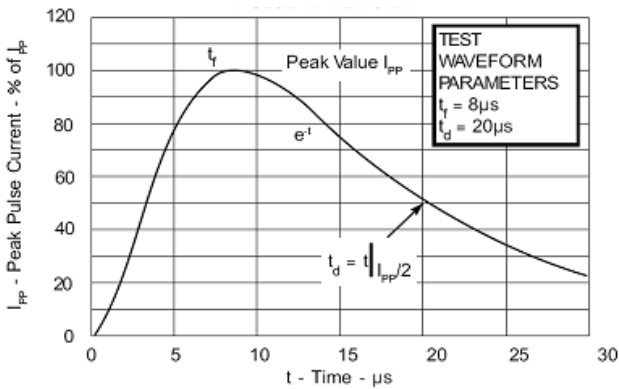
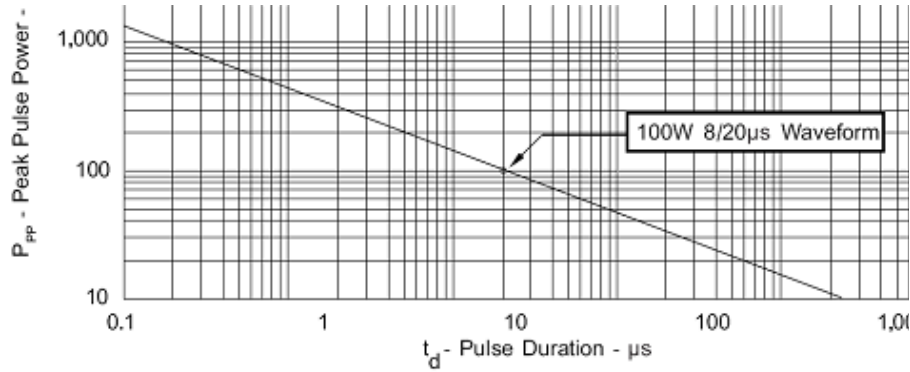

Figure 2. Pulse wave form

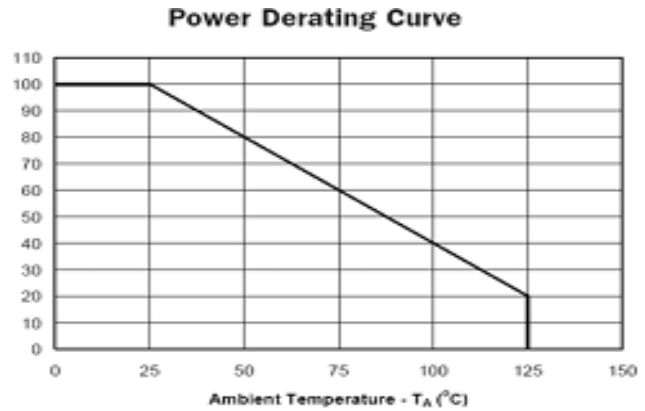

Figure 3. Power derating curve

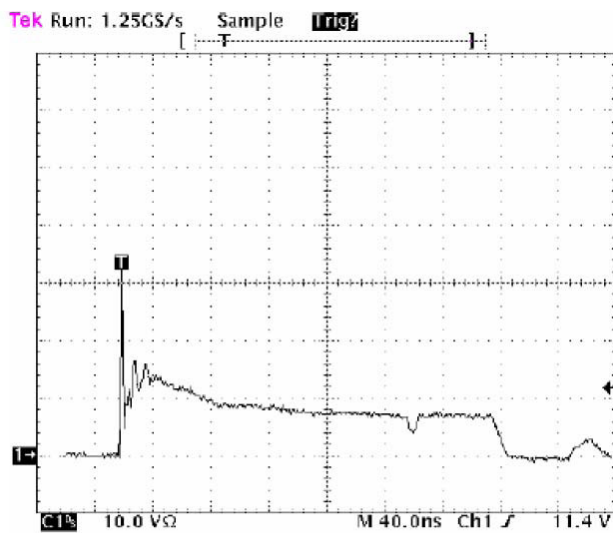

Figure 4. Positive 8kV contact per IEC

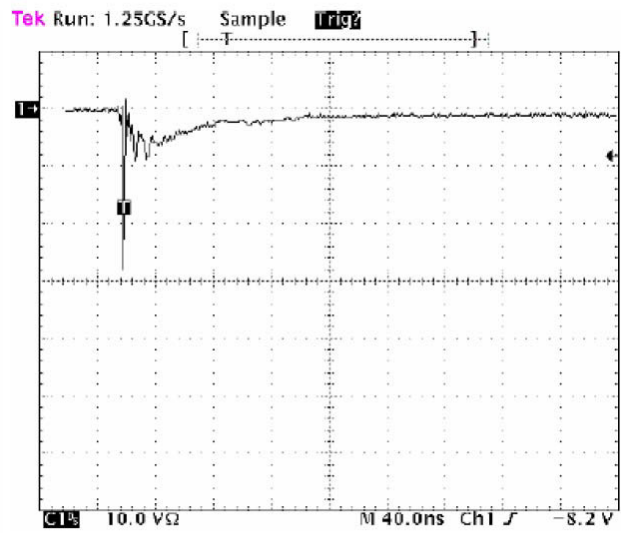
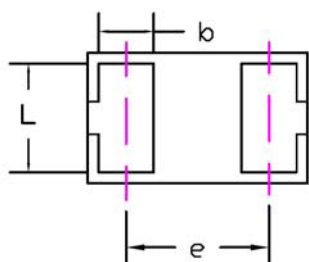
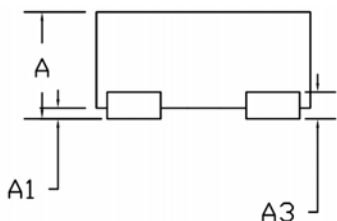
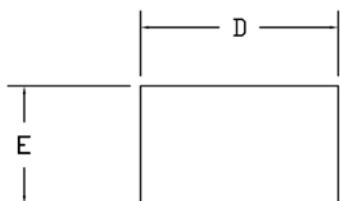

Figure 5. Negative 8kV contact per IEC

TVS/ESD Arrays - RLSD92QxxxV Series

Package dimension DFN-2L



Dimensions			
PKG.	X1:Extreme thin		
Ref.	Min	Nom	Max
A	0.4	-	0.5
A10	0.00	-	0.05
A3	0.125Ref		
D	0.951	0.00	1.05
E	0.550	0.60	0.65
B	0.200	0.25	0.30
L	0.450	0.50	0.55
e	0.65 BSC		

TVS/ESD Arrays - RLSD92QxxxV Series

Soldering footprint

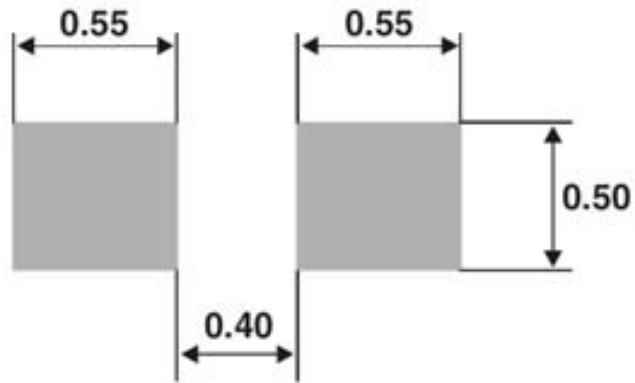

Part Number Code

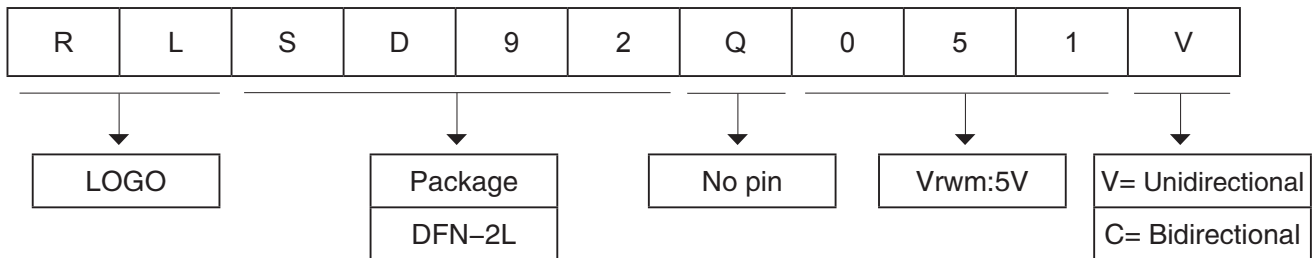

TVS/ESD Arrays - RLSD92QxxxV Series

Tape and reel

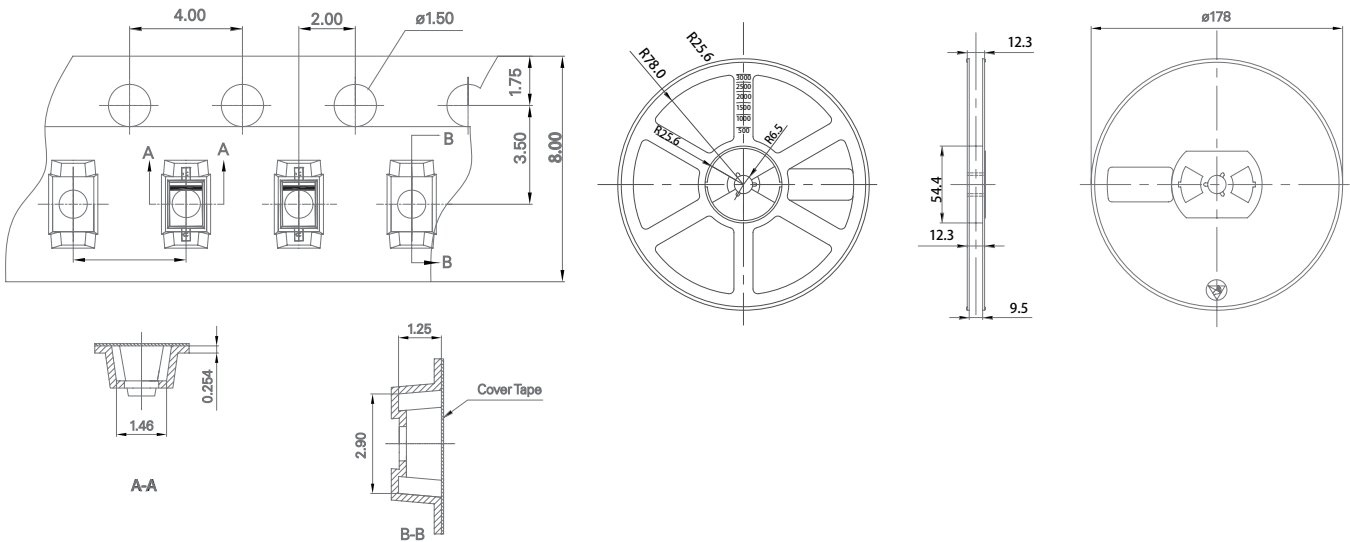

Ordering Information

Part Number	Package	Min. Order Qty.
RLSD92QxxxV	DFN-2L	3000pcs

Warehouse Storage Conditions of Products

Storage Conditions:

1. Storage Temperature: $-10^{\circ}\text{C}\sim+40^{\circ}\text{C}$
2. Relative Humidity: $\leq 75\% \text{RH}$
3. Keep away from corrosive atmosphere and sunlight.
4. Period of Storage: 1 year

RuiLongYuan Electronics Co., Ltd.

- Reproducing and modifying information of the document is prohibited without permission from Ruilongyuan International Inc.
- Ruilongyuan International Inc. reserves the rights to make changes of the content herein the document anytime without notification. Please refer to our website for the latest document.
- Ruilongyuan International Inc. disclaims any and all liability arising out of the application or use of any product including damages incidentally and consequentially occurred.
- Ruilongyuan International Inc. does not assume any and all implied warranties, including warranties of fitness for particular purpose, non-infringement and merchantability.
- Applications shown on the herein document are examples of standard use and operation. Customers are responsible in comprehending the suitable use in particular applications. Ruilongyuan International Inc. makes no representation or warranty that such applications will be suitable for the specified use without further testing or modification.
- The products shown herein are not designed and authorized for equipments requiring high level of reliability or relating to human life and for any applications concerning life-saving or life-sustaining, such as medical instruments, transportation equipment, aerospace machinery et cetera. Customers using or selling these products for use in such applications do so at their own risk and agree to fully indemnify Ruilongyuan International Inc. for any damages resulting from such improper use or sale.

Tel: +86-755-8290 8296

Fax: +86-755-8290 8002

E-mail: jack@ruilon.com